



Motorradzubehör

HORNIG

Upgrade your bike

CATALOGUE 
2012

F650/800GS (08-) | F650, CS, GS, ST & Dakar
F800S & ST, F800R | G650X & G650GS
K1200LT | K1200RS & GT
K1200R & R Sport | K1200S & GT (06-)
K1300S, K1300R, K1300GT
K1600GT & GTL
R850/1100/1150GS & Adventure
R850/1100/1150R & Rockster
R850/1200C & CL
R1100/1150RT & RS | R1100S
R1200R, RT, S & ST
R1200GS, Adv., HP2 & Megamoto
S1000RR

mhornig.com

WWW.MHORNIG.COM

FOREWORD

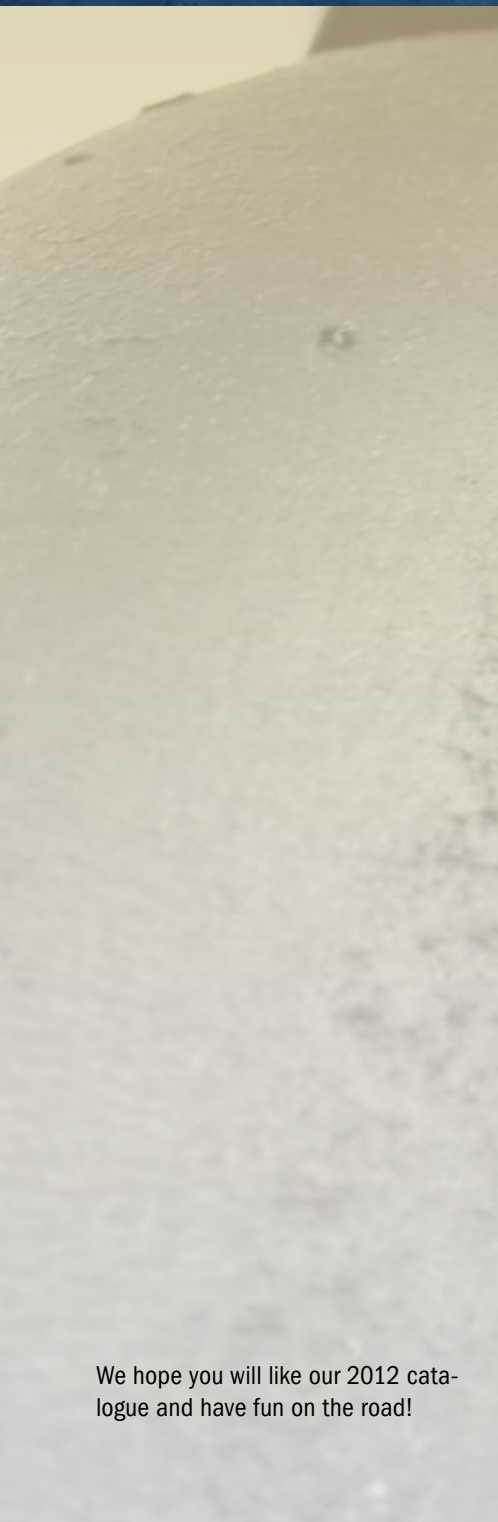

We hope you will like our 2012 catalogue and have fun on the road!



Foreword

We moved to our new building at the end of the 2011 motorcycle season. From now on you can find us at this location: Gewerbepark Chammünster Nord C5, 93413 Cham, Germany.

We offer you in our new building at about 2.000 sqm a Café and a big showroom with our latest custom BMW motorcycles and much accessories which you can of course touch and test.

We are also using a brand new logistic system in our high rack warehouse in order to ship your packages as fast as possible.

We're looking forward to meet you!





We wish you a great motorcycle
season 2012

Index

F 650 - 800 GS (2008-*)	page 6
F 650, CS, GS, ST, DAKAR	page 18
F 800 S & ST	page 28
F 800 R	page 40
G 650 X & G 650 GS	page 52
K 1200 RS & GT	page 60
K 1200 R & R SPORT	page 72
K 1200 S	page 86
K 1200 GT (2006-*)	page 104
K 1200 LT	page 114
K 1300 R	page 122
K 1300 GT	page 134
K 1300 S	page 144
K 1600 GT & GTL	page 158
R 850 - 1100 - 1150 GS & ADVENTURE	page 160
R 850 - 1100- 1150 R & ROCKSTER	page 178
R 850 - 1200 C & CL	page 196
R 1100 - 1150 RT	page 210
R 1100 S	page 224
R 1100 - 1150 RS	page 238
R 1200 GS, ADVENTURE, HP2 & MEGAMOTO	page 248
R 1200 R	page 284
R 1200 RT	page 304
R 1200 S, HP2 SPORT	page 318
R 1200 ST	page 336
S 1000 RR	page 348
Navigation & Communication	page 360
Accessories, Spare and war parts, Tools	page 368
Cases, topcases and attachments	page 396
Soft Bags	page 400
Clothes and stickers	page 408
Location plan & The Arber	page 410
Seat Alteration	page 412
How to order online?	page 414
Payment methods and shipping costs	page 416
Order form and GTAC	page 418



F650GS

built since 2008
798 ccm cylinder capacity
power:71 PS
max. torque 75 Nm at 4.500/min

F800GS

built since 2008
798 ccm cylinder capacity
power:85 PS
max. torque 83 Nm at 5.750/min

GPS Mounting

You need 1x GPS bracket adapter (048-0210) for mounting to the handlebar clamping support
1x GPS Mounting (44004) for mounting your GPS unit to the GPS bracket adapter

To 44004 fit all BMW Navigators, Garmin Zumo, SPIII, SP26**, 2720, Zumo 550, Zumo 660 and Nüvi series. GPS SP26** & 2720 owners will need to purchase the Garmin Motorcycle Mount.

Maybe you need an extra adapter for a TomTom navigator or our adapter for 1" Ram-Ball when you want to install a Ram-Mount.



ArtNo.	Description	Price
048-0210	GPS bracket adapter	€ 42,90
44004	GPS Mounting	€ 38,90
tomtom-Ad	Adapter for TomTom Rider Incl. screws for mounting in the GPS mount and the TomTom holder.	€ 9,55
tomt-Ad Ed 2	Adapter for TomTom 2nd Edition Incl. screws for mounting in the GPS mount and the TomTom holder.	€ 14,90
ram-1zoll	Adapter for 1" Ram-Ball	€ 29,90

Cover

Cover for the fluid reservoir. You simply stick it onto the fluid reservoir and can remove it without residue. It can be fixed with some silicone or something alike.

ArtNo.	Description	Price
0703	anodized	€ 19,90
0704	black anodized	€ 20,90
0705	polished	€ 19,90
s2ml	Silicone 2ml	€ 0,40



Mirror Extensions

Our Mirror Extensions are the perfect solutions when you see mainly your shoulders in the rear mirrors. The mirrors will be moved some centimeters away from each other and that creates the necessary space in order to improve the view to the back.

ArtNo.	Description	Price
BK 02	Mirror Extensions 1 Set (M10)	€ 49,95





Oil temperature gauge

The temperature of the cooling water is usually different to the temperature of the engine oil! The oil temperature gauge helps you warm up your bike easier!

BMW F 650 GS (800) (0218) and F800 GS (0219)

ArtNo.	Description	Price
10034208	Oil temperature gauge	€ 62,95



Brake pedal enlargement

This special part is made of extremely handy aluminium and makes for safe braking. It gets mounted with two screws, u-screws, nut and tubes which are all supplied.

For all BMW F800GS & BMW F650GS from 2008 - *

ArtNo.	Description	Price
0128	Brake pedal enlargement	€ 18,50



Handlebar height riser 20mm

Those who like to go offroad and do so frequently, will find the 20 mm handlebar height increase indispensable. It makes it much easier to ride while standing. It also facilitates a more pleasant, relaxed position while sitting. Significantly increases touring comfort.

It takes just moments to fit. Delivery includes screws and TÜV certificate.

ArtNo.	Description	Price
048-0150	Handlebar height riser 20mm	€ 20,90



Number Plate Deflector

Made of 1mm high quality stainless steel. This guard is pre drilled to mount behind the rear number plate. It is very effective at keeping the luggage, pillion & rider clean of mud and dirt.

ArtNo.	Description	Price
42000	Width 200mm	€ 28,90
42001	Width 175mm	€ 28,90

Sidestand foot enlargement

Feel safer parking your bike on dirt or asphalt with a sidestand foot enlargement. More than 100% bigger contact area. Made of high quality aluminium. Black anodized. Easy to install. Doesn't fit for lowered bikes.

ArtNo.	Description	Price
0708	Sidestand foot enlargement F800GS	€ 19,95
0717	Sidestand foot enlargement F650GS MY 2008-*	€ 19,90



Crashbars

Our crashbars are made of high-quality steel and are special designed for your BMW F650GS & F800GS 08 model or newer. The crashbars are designed to be very robust and allow an equal distribution of the forces so that you and your bike are protected in the best possible way. Crashbars offer a very good protection but they can reduce the cornering angle. (1 Set left & right)

ArtNo.	Description	Price
TN690	Crashbars black	€ 139,90

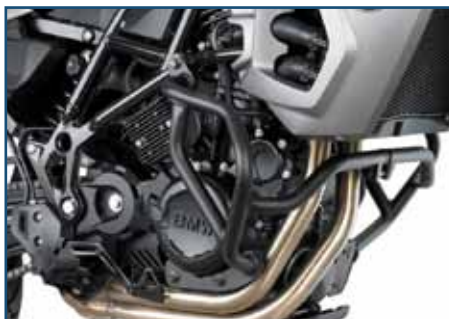

Crashbars

Our crashbars are made of high-quality steel and are specially designed for your F650GS and F800GS 2008 model or newer. The crashbars are designed to be very robust and allow an equal distribution of the forces so that you and your bike are protected in the best possible way. Crashbars offer a very good protection but they can reduce the cornering angle. Well suited for drivers with long legs. (1 Set left & right)

ArtNo.	Description	Price
SBL.07.556.100	Crashbars black	€ 174,95



Main Stand

This main stand is characterized by its accuracy of fit and its stability. It is very instrumental in any little work you have to do on your bike just like changing the brake pads and so on...

ArtNr.	Beschreibung	Preis
HPS.07.557.100	Main Stand F800GS	€ 124,95
HPS.07.470.100	Main Stand F650GS MY 2008-	€ 124,95





Adjustable Foot pegs

The Vario Footrest System (Joint) will be mounted to the motorcycle like the original footpeg.

The adjustable Footrest system consists of 3 parts: Vario Joint, Vario Plate and the Footrest. All Items sold as a set for left and right.



Part 1

The Vario Footrest System (Joint) will be mounted to the motorcycle like the original footpeg. The Joint is silver anodized.



Part 2

The Vario Plate is the part between the Footpeg and the Vario Footrest System (Joint). The Vario Plate is available in 3 length. We recommend 50mm only for the pillion rider.



ArtNo.	Description	Price
051 02 04 00	Driver Vario Footrest System	€ 41,90
051 02 04 10	Pillion rider Vario Footrest System	€ 41,90
051 00 00 23	23mm Vario Plate	€ 44,50
051 00 00 30	30mm Vario Plate	€ 44,90
051 00 00 50	50mm Vario Plate (only pillion rider)	€ 45,90
050 00 04 00 8	Super Grip Footrest black	€ 51,80
050 00 04 00 1	Super Grip Footrest silver	€ 51,70
050 00 01 00 8	Racing Footrest black	€ 29,90
050 00 01 00 1	Racing Footrest silver	€ 29,95

Part 3

The Footpeg will be mounted to the Vario Plate. The Super Grip Footpegs are available in silver with black rubber.

The Racing Footpegs are available in black or silver. All Items sold as a set for left and right.

Synto brake- and clutch lever

Synto is the name of the 6x adjustable CNC high-precision brake and clutch made of aluminium. Combines elegance and functionality. Handling pure!

* 6 x adjustable CNC high-precision levers

* Racing proven Extremely light weight / 60g per lever

* CNC milled from high tech aeronautical norm aluminium EN 2017

* Perfect design – convincing finish

* Brilliant control feeling * Aerodynamic louver

* Levers ca. 2 cm shorter than original

* Predetermined breaking point at long version

* Adjuster colour is always black, only the black lever has a silver adjuster * For brake and clutch

* Including street homologation TÜV part certificate (ABE)

There is a video for this product online: www.mhornig.com



ArtNo.	Description	Price
BH27-KH37-15-11-L	black-silver	€ 218,00
BH27-KH37-17-15-L	red-black	€ 218,00
BH27-KH37-14-15-L	blue-black	€ 218,00



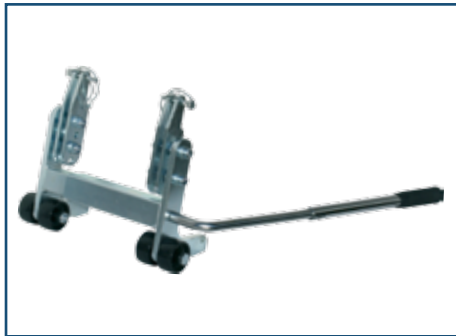

Lifter

Our front lifter fits for BMW F650GS twin, all F800 and G650X bikes. It is specially made for the lowered F650GS twin. It is perfect for care, overwinter, change wheels and servicing. Made of steel, zinc-plated and quality „Made in Germany“.

ArtNo.	Description	Price
Lifter010	Lifter	€ 75,90



LED turning signals

Awesome brightness, fitted in seconds and including electronics on the back of the panel to ensure the correct flash rate. It is the complete turning signal and has a homologation. So it is the first road legal LED for BMW bikes! The LEDs flash yellow.

Sold in pairs (for left and right).

ArtNo.	Description	Price
01006	1 pair of LED turning signals with clear lenses	€ 89,95
01006-g	1 pair of LED turning signals with grey lenses	€ 89,95



Clear indicator lens

Clear indicator lenses. Sold in a set (2 pieces).

And if you want, also single.

With E-Mark, so they are homologated for the EU.

Shipping: 2 lenses incl. orange bulbs.

ArtNo.	Description	Price
CTS-0037	Clear indicator lens	€ 20,90
CTS-0037-g	Grey indicator lens	€ 20,95



Indicator bulb

Either orange or special coated. The special coated one only lights orange when you use the indicator (usually used with transparent lenses).

Single

ArtNo.	Description	Price
BLWB-CBUS	orange coated bulb 12V/10W	€ 2,55
BLWBT-CBUS	special coated bulb 12V/10W	€ 5,99

Rear Mudguard

This shapely Rear Hugger is made of glass-fibre reinforced plastic or carbon fibre and ensures that your legs, the suspension and the rear part of your BMW F650GS & F800GS will stay dry and clean. Does not fit for lowered bikes.

ArtNo.	Description	Price
40100	GRP black primed	€ 189,00
40100-1	Carbon Rear Hugger	€ 239,00



Mudguard extension

The mudguard extension gives the F 650 (Twin) a new and most striking appearance. It adds a genuine long distance flair.

This easy to fit and extremely strong plastic item also offers added protection against dirt and splashes.

The paintable mudguard extension is also easy to fit to the F 800 GS, and makes the beak look longer.

ArtNo.	Description	Price
048-0342	Mudguard extension	€ 79,90



Carbon protectors clutch cover

Our Carbon protectors will make scratched and damaged side covers a thing of the past. Made of light, sturdy carbon-fibre laminate, they are resistant to almost anything. So adventurous offroad rides will not leave a mark on the side covers - and nor will the soles of your enduro boots.

Beautifully shaped protection in elegant material that is easy and straightforward to fit.

ArtNo.	Description	Price
048-0340	Carbon protectors clutch cover	€ 59,90



Carbon protectors alternator cover

Our Carbon protectors will make scratched and damaged side covers a thing of the past. Made of light, sturdy carbon-fibre laminate, they are resistant to almost anything. So adventurous offroad rides will not leave a mark on the side covers - and nor will the soles of your enduro boots.

Beautifully shaped protection in elegant material that is easy and straightforward to fit.

ArtNo.	Description	Price
048-0338	Carbon protectors alternator cover	€ 59,90





Hand Protectors

These hand protectors are made of virtually indestructible plastic; they are modern in design, offer a high level of protection, and can easily be fitted to your BMW F650GS or F800GS using the fitting sets (included).

The hand protector offers optimum protection against wind and weather. A very strong, sturdy construction which has proved itself time and again in many rallies and on other motor cycles.

- Many colours available

(Note: not available in BMW colours)

- Vibration isolation maintained (100%)

- For use in conjunction with heated grips

- Includes special adapters for fitting



ArtNo.	Description	Price
F650GS MY 08-		
040-7081	Set Hand Protectors black	€ 79,90
040-7301	Set Spoiler for hand protectors black	€ 20,90
F800GS		
040-6681	Set Hand Protectors black	€ 79,90
040-7301	Set Spoiler for hand protectors black	€ 20,90





High Windscreen

Transparent and aerodynamic wind protection with a edge protection (black). Combined to the F800GS screen 22cm higher and to the F650GS screen 26cm higher. Size (HxW): 440 x 460 mm

With original hand protectors the steering angle will be reduced.

ArtNo.	Description	Price
D333STG	Windscreen high	€ 110,30



Windscreen

Lots of riders will want more wind protection, because the original windscreen is extremely sporty in design. This windscreen is much bigger, and has a different aerodynamic shape. Turbulence around the helmet is minimised and protection against the weather improved.

ArtNo.	Description	Price
048-0370	Windscreen clear	€ 129,90
048-0372	Windscreen tinted	€ 129,90



V-Stream Windscreen

Revolutionizes windscreen performance! The advanced ,V' shape and dimensional contours push the wind vortex out and away from the riders' helmet, resulting in a peaceful, quiet environment. This improvement is notable for the passenger as well. This windshield is 3X more resistant to abrasion than acrylic materials, and has superior crack and impact resistance.

Covered by 3-YEAR UNBREAKABLE WARRANTY!

ArtNo.	Description	Price
115112	Clear, H 50,8cm, W 43,2cm	€ 229,00
Z2435	Clear, H 45,5cm, W 42 cm	€ 209,00
Z2434	Clear, H 38cm, W 38cm	€ 179,00
Z2432	Dark tint, H 30,5, W 33,5cm	€ 169,00



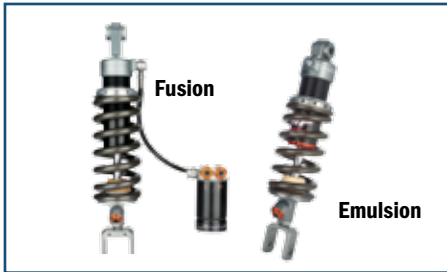

ArtNo.	Description	Price
17.06.8D.87	Fusion suspension with reservoir fixed by a steel flex	€ 849,00
17.06.8D.87-k	Fusion suspension with reservoir fixed by a steel flex short	€ 849,00
17.06.9D.87	Emulsion suspension	€ 549,00
17.06.9D.87-k	Emulsion suspension short	€ 549,00
/02	Hydraulic preload adjustment	€ 229,00

WP Suspension rear

Fits for F800GS.

Our WP suspensions will be specially adjusted for you! Because of this please inform us about your weight with clothes and helmet, the weight of your luggage (perhaps pillion rider), where you ride (street, off-road, race) and how you ride (sport, touring, and so on) in the „comment“ of your order.

The Fusion as well as the Emulsion suspension can be combined with the hydraulic preload adjustment. (productnr. /02)

For extra charge you can choose any spring colour you like.

The short version reduces the height of the seat about 50mm, the fork tubes in the front can be moved up for about 45mm.

High/Low speed compression separately adjustable, each 16 times (256 possibilities) (only Spin and Fusion) adjustable rebound preload adjuster

For drivers wanting the utmost from their machine Exceptional cooling properties due to the use of heat diverting aluminium alloys, therefore constant shock absorption and longer life

Lightweight through use of high quality materials Adjustable length is standard Recognised safety certificate

Sebring Phantom

F 650/800 GS ab 08 Typ E650G 52kW /Typ E8GS 63kW Slip-on incl. front exhaust silencer, Twister, with EG/ABE. Choose the cover you like most! The exhaust is very easy to install and much lighter than the original one. But the most important argument is the deep and throaty sound combined with more power and more torque throughout the whole speed range. Real driving pleasure and of course with ABE (European Homologation)!

ArtNo.	Description	Price
ANT1034	Slip on, EG/ABE Stainless Steel	€ 466,00
ATT1034	Slip on, EG/ABE Titanium	€ 528,00





How do you sit on your motorcycle seat? Do you want to change something in your seat?

Then read through the pages of the catalog **SEAT ALTERATION**.
We will change your seat exactly like you want it to be.

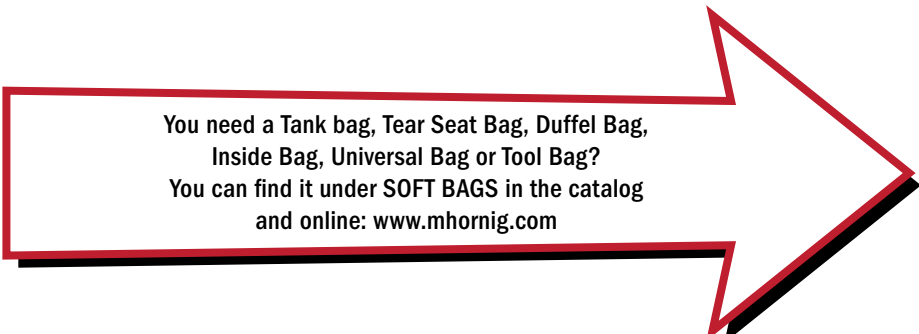

You need a Tank bag, Tear Seat Bag, Duffel Bag,
Inside Bag, Universal Bag or Tool Bag?
You can find it under **SOFT BAGS** in the catalog
and online: www.mhornig.com





F650 Funduro, ST,GS,Dakar,CS

built since 1993 (Funduro)

652 ccm cylinder capacity

power:48/50 PS

max. torque 57/60/62 (CS) Nm

Speedometer trims F650 & F650ST

These polished trims for the speedometer, rev counter and temperature gauge are an optical improvement for your 650. Simply stick them to the speedometer e.g. with silicone. Easily removed without any residue.

ArtNo.	Description	Price
0405	polished	€ 34,90
s2ml	Silicone 2ml	€ 0,40



Key holder with emblem

Useful key holder made of knurled aluminium, polished on top, with our emblem. Just slot in the „Emergency key“ and fix with a setscrew. 0076 : Also possible to hook in a carabineer.

ArtNo.	Description	Price
0075	polished without eye	€ 19,70
0076	polished with eye	€ 28,50



Handlebar screw cover

An optical improvement for your bar risers and is made of aluminium. An integrated o-ring ensures a snug fit. For F650 & F650ST

ArtNo.	Description	Price
0066	polished	€ 12,90
0266	anodized	€ 13,80

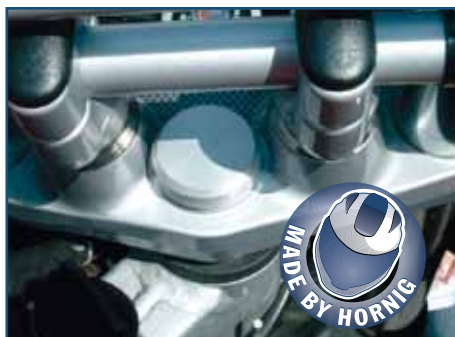

Oil temperature gauge

The temperature of the cooling water is usually different to the temperature of the engine oil! The oil temperature gauge helps you warm up your bike easier! Fits for F650 DAKAR (0173), F 650 DAKAR (F650DAK/04), F650GS (0172), F650GS (F650GS/04)

ArtNo.	Description	Price
10034325	Oil temperature gauge	€ 62,95





Crashbars CS Scarver bikes

Our crashbars are made of high-quality steel and are special designed for your F650 02 model or newer. The crashbars are designed to be very robust and allow for an equal distribution of forces in a crash. You and your bike are protected in the best possible way.

Crashbars offer a very good protection but they can reduce the cornering angle.

ArtNo.	Description	Price
SBL.07.211.100	Crashbars black	€ 129,95
SBL.07.211.100/S	Crashbars silver	€ 129,95



Crashbars GS Dakar bikes

Our crashbars are made of high-quality steel and are special designed for your F650GS/Dakar 00 model or newer. The crashbars are designed to be very robust and allow for an equal distribution of forces in a crash. You and your bike is protected in the best possible way.

Crashbars offer a very good protection but they can reduce the cornering angle.

ArtNo.	Description	Price
SBL.07.101.100	Crashbars black	€ 159,95



Brake Pedal Extension

Fit for F650CS.

Nicely machined aluminium, knurled and clear anodized. Simply slips on and is held in place with a set-screw.

ArtNo.	Description	Price
0180	anodized	€ 22,15



Mirror Extensions

Our Mirror Extensions are the perfect solution when you see mainly your shoulders in the rear mirrors. The mirrors will be moved some centimeters out from each other in order to improve the view to the rear.

For BMW F650CS.

ArtNo.	Description	Price
BK 12	Mirror Extensions 1 Set (M8)	€ 49,95

Dash pad

Dash pad with carbon fibre effect

- Protects this very visible part of your bike from your keys and enhances its appearance with this scratch resistant, self adhesive pad.

No more cutting required, fits exactly.

Fits F 650 & F 650 ST.



ArtNo.	Description	Price
80075	Dash pad	€ 7,40





Kickstand

For BMW Scarver F 650 CS - also with low suspension. Perfectly suitable for removing the wheels. Saves tyres in winter. Very easy to store because of its removable bar end.

ArtNo.	Description	Price
scarver08	Kickstand	€ 75,90



Clear tail light lens

White rear light with long-life LEDs. Super optics, quick installation and with E-mark. Specially adapted to the electrics of the F 650 ST / GS & Dakar. The LED rear light gives your motorcycle an entirely new appearance. You need not constantly worry either that the lamp in the rear light is broken, thus making you an accident risk.

ArtNo.	Description	Price
TT.044-0395	Clear tail light lens + LED	€ 59,95
0867	White tail light lens + LED	€ 59,90



Clear indicator lenses

E-homologated! Sold in pairs, amber bulbs included! Clear lenses fits BMW F 650 CS/GS Scarver und Dakar. (rear or front)

ArtNo.	Description	Price
WLB-03	1 Set clear lenses	€ 18,90

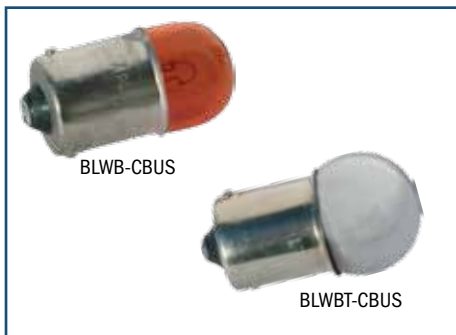

Indicator bulb

Either orange or special coated. The special coated one only lights orange when you use the indicator (usually used with transparent lenses). Single

ArtNo.	Description	Price
BLWB-CBUS	orange coated bulb 12V/10W	€ 2,55
BLWBT-CBUS	special coated bulb 12V/10W	€ 5,99

LED tail light panel

Far brighter than the standard set up! Fitted in seconds by anyone.
Features up to 24 red high intensity LEDs and (if necessary) 4 white ones for the number plate.
Will suit models with or without ABS fitted.

ArtNo.	Description	Price
10102-01	LED tail light panel	€ 82,90



Clear tail light lens

Clear tail light lens for a brilliant look for F650CS .
With a red bulb for stop and tail light.

ArtNo.	Description	Price
30102-01	Clear tail light lens	€ 54,90
12V21/5Red	Red bulb for rear- and brake light 12V/21/5Watt	€ 3,20



LED Taillight

Complete Taillight with integrated LED-board for simply exchange! Road legal.
For bikes with and without ABS (Int. ABS).
Fit for BMW F650CS.

ArtNo.	Description	Price
WLL-53-L	LED Taillight	€ 89,90
WL-53	Taillight lens (only lens)	€ 53,90



LED tail light panel

For F 650 ST/GS/Dakar.
High quality and fits very good.
24 red high performance-LEDs and the design provide optimal brightness.
The light for the license plate are also made of LEDs.
The installing is very easy.

ArtNo.	Description	Price
10104-01	LED tail light panel	€ 80,90





Windscreen F650 94-96

Our windscreen for your F650 1994 - 1996 model is characterised by high quality and a perfect fit. The windscreen will be shipped with an edge protection (black).
Smokey grey
HxW 460x423 mm

ArtNo.	Description	Price
D230S	Windscreen F650 94-96 model	€ 107,90



Windscreen tinted

Our windscreen for your F650GS 2000 - 2003 model has a special designed spoiler and is characterised by high quality and a perfect fit.
Wind screen with edge protection (black).
HxW 411x340 mm

ArtNo.	Description	Price
D234SG	Windscreen F650GS 00-03 model	€ 116,90



Windscreen

Our windscreen for your F650GS 2004 - 2007 model has a special designed spoiler and is characterised by high quality and a perfect fit. Cannot be installed together with the hand protection kit.
Wind screen will be shipped with an edge protection (black). HxW 395x440 mm

ArtNo.	Description	Price
D331STG	Windscreen F650GS 04-07 model	€ 89,90



Originally-shaped screen

his wind screen has the same shape the original.

For F 650 / F 650 ST, 97 - 00 model

Available in clear or smoke grey, length = 430mm.

ArtNo.	Description	Price
O-f650-rg	Smoke grey	€ 69,90
O-f650-K	Clear	€ 69,90



Spoiler screen

All windscreens are produced and tailored precisely.

For F 650 / F 650 ST, 97 - 00 model

Available in clear or smoke grey, length = 305mm.

ArtNo.	Description	Price
S-f650-rg	Smoke grey	€ 79,90
S-f650-K	Clear	€ 79,90



Touring Screen

All windscreens are produced and tailored precisely.

The shape of the Touring Screen is similar to the original screen but it is higher and wider than the original screen.

for F 650 / F 650 ST, 97 - 00 model

Available in clear or smoke grey, length = 460mm

ArtNo.	Description	Price
T-f650-rg	Smoke grey	€ 79,90
T-f650-K	Clear	€ 79,90



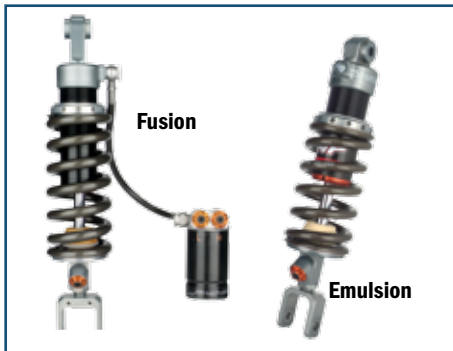

WP Suspension rear

Our WP suspensions will be specially adjusted for you! Because of this please inform us about your weight with clothes and helmet, the weight of your luggage (perhaps pillion rider), where you ride (street, off-road, race) and how you ride (sport, touring, and so on) in the order.

The Fusion as well as the Emulsion suspension can be combined with the hydraulic preload adjustment.

You can choose any spring colour you like.

High/Low speed compression separately adjustable, each 16 times (256 possibilities) (only Spin and Fusion) adjustable rebound preload adjuster

For riders wanting the upmost from their machine

Exceptional cooling properties due to the use of heat diverting aluminium alloys, therefore constant shock absorption and longer life. Lightweight through use of high quality materials. Adjustable length is standard
Recognised safety certificate.

ArtNo.	Description	Price
F650 MY 94-*		
17.06.08.02	Fusion suspension with reservoir fixed by a steel flex	€ 849,00
17.06.09.02	Emulsion suspension	€ 549,00
/02	Hydraulic preload adjustment	€ 229,00
F650GS & GS Dakar 00-*		
17.06.U8.06/8	Fusion suspension with reservoir fixed by a steel flex	€ 849,00
17.06.U9.06/8	Emulsion suspension	€ 549,00
/02	Hydraulic preload adjustment	€ 229,00
F650CS Bj. 02-*		
17.06.W8.04	Fusion suspension with reservoir fixed by a steel flex	€ 849,00
17.06.W9.04	Emulsion suspension	€ 549,00

WP Fork Springs

Our progressive WP fork springs are especially developed for your requirements and your BMW F650.

They ensure improved comfort and higher safety.

Special designs are possible.

Resistant to wear off.

With ABE

For BMW F650 94>

BMW F650 CS SCARVER 02>

BMW F650 GS 00>

BMW F650 GS DAKAR 00>

BMW F650 STRADA

BMW F650 STRADA 97>



ArtNo.	Description	Price
9932.0115/0205	1 Set Fork springs	€ 99,00
SAE10-15	Fork oil 1 L. with the right viscosity for your bike (SAE 10 - 15) You need this twice!	€ 19,95



How do you sit on your motorcycle seat?
Do you want to change something?

Then read through the pages of the catalog
SEAT ALTERATION.

We will change your seat exactly like you want it to be.

You need a Tank bag, Tear Seat Bag, Duffel Bag,
Inside Bag, Universal Bag or Tool Bag?
You can find it under **SOFT BAGS** in the catalog
and online: www.mhornig.com





F800S & ST

built since 2006

798 ccm cylinder capacity

power: 85 PS

max. torque 86 Nm at 5.800/min



GPS Mounting F800ST

Handlebar mounting for 22mm handlebars + Ram-Ball with M10 x 1,25 thread; CNC machined for TomTom Rider 2 and Garmin Zumo. Ram-Ball mount may be used for many other items, too.
Colour: Black

Fits for BMW F800ST.



GPS Mounting F800S

Plug for BMW handlebars with inside diameter of 16mm. Just insert the CNC machined plug in the open part of the handlebar (usually closed with a plastic plug). The plug will stay in place thanks to the expansion fastener. The external diameter of the part where you mount your GPS is 22,5mm to fit almost any navigation system.

Colour: Chrome or Black

Ram-ball is also possible. Art-no.: NH 3/1
Fits for BMW F800S.



With or without hinge in order to move your navigation system in the best position.

ArtNo.	Description	Price
NH 3 ch	Chrome Plug	€ 39,95
NH 3 sw	Black Plug	€ 39,95

ArtNo.	Description	Price
NH 1/3 sw 22	GPS Mounting without hinge black	€ 34,95
NH 2/1 sw 22	GPS Mounting with hinge black	€ 44,95



Adjustable Foot pegs

The Vario Footrest System (Joint) will be mounted to the motorcycle like the original footpeg.

The adjustable Footrest system consists of 3 parts: Vario Joint, Vario Plate and the Footrest. All Items sold as a set for left and right.



Part 1

The Vario Footrest System (Joint) will be mounted to the motorcycle like the original footpeg. The Joint is silver anodized.



Part 2

The Vario Plate is the part between the Footpeg and the Vario Footrest System (Joint). The Vario Plate is available in 3 length. We recommend 50mm only for the pillion rider.



ArtNo.	Description	Price
051 02 03 00	Driver Vario Footrest System	€ 41,90
051 02 03 10	Pillion rider Vario Footrest System	€ 41,90
051 00 00 23	23mm Vario Plate	€ 44,50
051 00 00 30	30mm Vario Plate	€ 44,90
051 00 00 50	50mm Vario Plate (only pillion rider)	€ 45,90
050 00 04 00 8	Super Grip Footrest black	€ 51,80
050 00 04 00 1	Super Grip Footrest silver	€ 51,70
050 00 01 00 8	Racing Footrest black	€ 29,90
050 00 01 00 1	Racing Footrest silver	€ 29,95

Part 3

The Footpeg will be mounted to the Vario Plate. The Super Grip Footpegs are available in silver with black rubber.

The Racing Footpegs are available in black or silver. All Items sold as a set for left and right.

Cover

Cover for the fluid reservoir. You simply stick it onto the fluid reservoir and can remove it without residue. It can be fixed with some silicone or something alike.

ArtNo.	Description	Price
0703	anodized	€ 19,90
0704	black anodized	€ 20,90
0705	polished	€ 19,90
s2ml	Silicone 2ml	€ 0,40



Shift lever extension

Many BMW riders think that their shift lever is a little too thin and doesn't give enough grip when they're shifting.

This enlarger will solve this problem for you as it offers more grip and a more sporty look for your bike. Available in polished or anodized.

ArtNo.	Description	Price
0190	polished	€ 21,40
0390	anodized	€ 21,80
0195	polished with o-rings	€ 23,50
0395	anodized with o-rings	€ 23,90
19x3	O-ring	€ 0,65

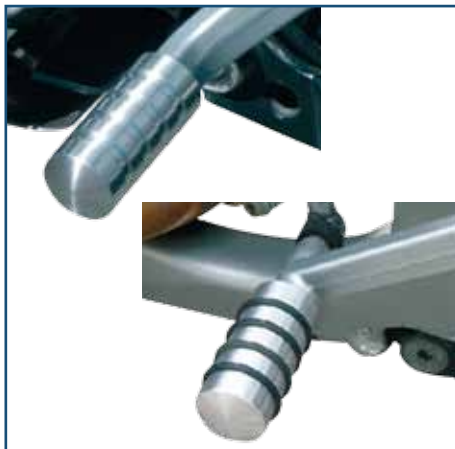

Sidestand foot enlargement

Feel safer parking your bike on dirt or asphalt with a sidestand foot enlargement. More than 100% bigger contact area. Made of high quality aluminium.

Black anodized.
Easy to install.

ArtNo.	Description	Price
0722	Sidestand foot enlargement	€ 20,90



Synto brake- and clutch lever

Synto is the name of the 6x adjustable CNC high-precision brake and clutch made of aluminium. Combines elegance and functionality. Handling pure!

* 6 x adjustable CNC high-precision levers

* Racing proven Extremely light weight / 60g per lever

* CNC milled from high tech aeronautical norm aluminium EN 2017

* Perfect design – convincing finish

* Brilliant control feeling * Aerodynamic louver

* Levers ca. 2 cm shorter than original

* Predetermined breaking point at long version

* Adjuster colour is always black, only the black lever has a silver adjuster * For brake and clutch

* Including street homologation TÜV part certificate (ABE)

There is a video for this product online: www.mhornig.com

ArtNo.	Description	Price
BH27-KH37-15-11-L	black-silver	€ 218,00
BH27-KH37-17-15-L	red-black	€ 218,00
BH27-KH37-14-15-L	blue-black	€ 218,00





Superbike Handlebar

Sporty riding without carrying your whole weight on your lower arms is the dream of many riders. To meet this wish, a Superbike handlebar conversion has been developed which with its tapered handlebars and full black anodizing not only looks sophisticated but also ensures sporting performance with very little strain on the rider. The Superbike handlebar conversion includes all components necessary for fitting.

Fits for all BMW F800S with ABS!

ArtNo.	Description	Price
50800640406	Superbike Handlebar	€ 419,00



Mirror Extensions

Our Mirror Extensions are the perfect solutions if you see mainly your shoulders in the mirrors. The mirrors will be moved 5cm out in order to improve the view to the rear.

ArtNo.	Description	Price
BK 08	Mirror Extensions 1 Set	€ 49,95



Brake pedal enlargement

This brake pedal enlargement is nicely machined of aluminium, knurled and anodized. It is quite simple to install - just slip it on and lock in place with two set-screws.

ArtNo.	Description	Price
0182	anodized	€ 23,80



Fork-Crash-Pads

These crash-pads for forks are made of cnc lathed plastic (Nylon). The mounting is made of cnc milled and anodized aluminium.

These crash pads provide additional protection for your fork.

Shipment includes the crash pads (left and right) and the mounting.

ArtNo.	Description	Price
FP100	Fork-Crash-Pads	€ 49,00

LED turning signals

Awesome brightness, fitted in seconds and including electronics on the back of the panel to ensure the correct flash rate. It is the complete turning signal and has a homologation. So it is the first road legal LED for BMW bikes! The LEDs flash yellow.
Sold in pairs (for left and right).

ArtNo.	Description	Price
01006	1 pair of LED turning signals with clear lenses	€ 89,95
01006-g	1 pair of LED turning signals with grey lenses	€ 89,95



Clear indicator lens

Clear indicator lenses. Sold in a set (2 pieces).
And if you want, also single.
With E-Mark, so they are homologated for the EU.
Shipping: 2 lenses incl. orange bulbs.

ArtNo.	Description	Price
CTS-0037	Clear indicator lens	€ 20,90
CTS-0037-g	Grey indicator lens	€ 20,95



Indicator bulb

Either orange or special coated. The special coated one only lights orange when you use the indicator (usually used with transparent lenses).
Single

ArtNo.	Description	Price
BLWB-CBUS	orange coated bulb 12V/10W	€ 2,55
BLWBT-CBUS	special coated bulb 12V/10W	€ 5,99

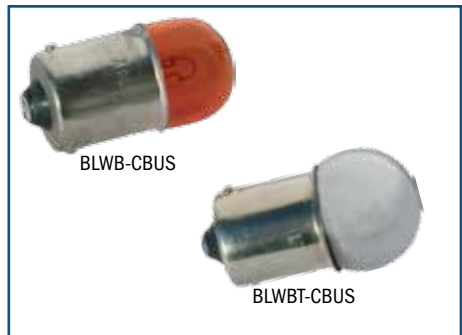

Clear tail light lens

White rear light with long-life LEDs. Super optics, quick installation and with E-mark. Specially adapted to the electrics of the F800S & ST.
The LED rear light gives your motorcycle an entirely new appearance. You need not constantly worry either that the lamp in the rear light is broken, thus making you an accident risk.

ArtNo.	Description	Price
TT.044-0395	Clear tail light lens + LED	€ 59,95
0867	White tail light lens + LED	€ 59,90





Crash-Pads Slider

Our Crash-Pads or Sliders protect your frame, engine and fairing of your motorcycle. This crash pad is designed to fit perfect to your motorcycle. It is made of high-strength milled aluminium and high-strength POM plastic. All our pads are screwed to your motorcycle at least at 2-3 points. The advantage over round crash pads is that these slider can't break or snag on something on the road. Shipment: Crash Pads for the left and right side with mounting.

ArtNo.	Description	Price
RLBM01-F800R-S	Crash-Pads Slider	€ 239,00



Rear Hugger

Made of carbon fibre and provides ultimate protection for the rear shock absorber!

Spend less time cleaning, more in riding!
shipping 8-10 weeks

ArtNo.	Description	Price
KHO.001.F800S.K	Rear Hugger	€ 259,90



Engine Spoiler short

This bellypan is made of high quality fibre-glass reinforced synthetic material (GRP) or carbon fibre and is especially designed to give your BMW F800R a sporty look. Easy to install, can be used with the centre stand. Incl. all fastener and install instruction. The GRP version is black primed.

ArtNo.	Description	Price
40155	GRP Engine Spoiler	€ 219,00
40155-1	Carbon Engine Spoiler	€ 265,00



Tank Centre Panel

This cover for the middle part of the tank is made of carbon fibre which looks very sporty on your BMW F800S, ST & R. Quite resistant to scratches and so on. Fits for BMW F800S & ST.

ArtNo.	Description	Price
TAO.002.F800S.K	Tank Centre Panel	€ 299,90

Carbon protector for clutch cover

Elegant yet effective! Unfortunately, when the F 800 S falls, it always falls right on the clutch cover. This can have nasty consequences, or at any rate is certain to leave some unsightly scratches on the cover. This is where our carbon protector comes in, providing an elegant visual enhancement to the black clutch cover.

ArtNo.	Description	Price
616-0035	Carbon protector for clutch cover	€ 59,90



Carbon protectors alternator cover

Our Carbon protectors will make scratched and damaged side covers a thing of the past. Made of light, sturdy carbon-fibre laminate, they are resistant to almost anything. So adventurous offroad rides will not leave a mark on the side covers - and nor will the soles of your enduro boots. Beautifully shaped protection in elegant material that is easy and straightforward to fit.

ArtNo.	Description	Price
048-0338	Carbon protectors alternator cover	€ 59,90



Engine spoiler

Aerodynamics taken a stage further. With the F800S, the original fairing has been supplemented with side parts for full covering. It fits neatly on the standard cover. Engine cooling is ensured by refined air openings.

ArtNo.	Description	Price
50800619603	Spoiler (primed)	€ 549,00



Dash pad

Carbon look - protects this very visible part of your bike from your keys and enhances it's appearance with this scratch resistant, self adhesive pad.

ArtNo.	Description	Price
80076	Dash pad for F800S	€ 10,30





V-Stream Windscreen

Revolutionizes windscreen performance! The advanced ,V' shape and dimensional contours push the wind vortex out and away from the riders' helmet, resulting in a peaceful, quiet environment. This improvement is notable for the passenger as well. Tough FMR coated polycarbonate gives VStream windshields outstanding clarity and strength characteristics unmatched by any windshield maker worldwide. This windshield is 3X more resistant to abrasion than acrylic materials, and has superior crack and impact resistance. 4.5mm FMR Hard coated Polycarbonate. Covered by 3-YEAR UNBREAKABLE WARRANTY! Uses bike's existing windshield mount points, with additional slotted mounting points on headlight.



Windshield V-Stream, design flat, clear, with homologation, Height 42 cm, Width 41 cm

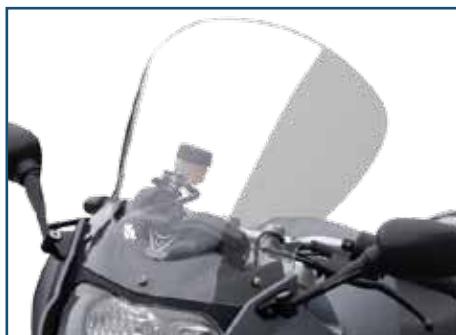

Windshield V-Stream, design high, clear, with homologation, Height 49 cm, Width 43 cm

ArtNo.	Description	Price
115104	Windscreen, design flat h42 cm, w41 cm	€ 139,00
115105	Windscreen, design high h49 cm, w43 cm	€ 179,00

High Windscreen

Transparent and aerodynamic wind protection with a spoiler as air deflector and a edge protection (black).

Compared to the F800S screen 17cm higher and to the F800ST screen 7cm higher.

Size (HxB): 450 x 320 mm

ArtNo.	Description	Price
D332ST	High Windscreen clear	€ 99,90



Touring screen

The touring screen has the same shape as the original screen (S) 345mm high, with an additional upwardly tilted airfoil over its entire width to deflect wind pressure away from the rider, ensuring an easy, relaxing ride, even on long trips.

ArtNo.	Description	Price
t-f800-rg	Smoke grey	€ 79,90
t-f800-k	Clear	€ 79,90



Vario touring screen

This touring screen has a spoiler at the top of the airfoil; the spoiler can be adjusted for height and angle in seven positions. The air current deflected behind the spoiler reduces the otherwise annoying turbulence. 365mm high

ArtNo.	Description	Price
vt-f800-rg	Smoke grey	€ 119,90
vt-f800-k	Clear	€ 119,90



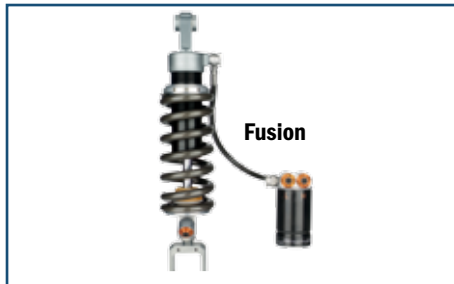

WP Suspension rear

Our WP suspensions will be specially adjusted for you! Because of this please inform us about your weight with clothes and helmet, the weight of your luggage (perhaps pillion rider), where you ride (street, off-road, race) and how you ride (sport, touring, and so on) in the „comment“ of your order.

The Fusion as well as the Emulsion suspension can be combined with the hydraulic preload adjustment. (productnr. /02)

You can choose any spring colour you like.

The short version is 11mm shorter. That reduces the height of the seat more than 20mm.

High/Low speed compression separately adjustable, each 16 times (256 possibilities) (only Spin and Fusion) adjustable rebound preload adjuster

For riders wanting the upmost from their machine Exceptional cooling properties due to the use of heat diverting aluminium alloys, therefore constant shock absorption and longer life

Lightweight through use of high quality materials

Adjustable length is standard.

Recognised safety certificate

You can find more suspensions and accessories online: www.mhornig.com

ArtNo.	Description	Price
17.06.8B.82	Fusion suspension with reservoir fixed by a steel flex	€ 849,00
17.06.9B.82	Emulsion suspension	€ 549,00
17.06.8B.83	Fusion suspension with reservoir fixed by a steel flex short	€ 849,00
17.06.9B.83	Emulsion suspension short	€ 549,00
/02	Hydraulic preload adjustment	€ 229,00



Sebring Twister

F800S & ST Typ E8ST 62.5kW

Slip-on incl. front exhaust silencer, Twister, with EG/ABE. Choose the cover you like most! The exhaust is very easy to install and much lighter than the original one. But the most important argument is the deep and throaty sound combined with more power and more torque throughout the whole speed range. Real driving pleasure and of course with ABE (European Homologation)!

ArtNo.	Description	Price
TAT4101024K	slip on, EB/ABE incl. Cat., Aluminium	€ 538,00
TTT4101024K	slip on, EG/ABE incl. Cat., Titanium	€ 650,00
TAT4101024	slip on, EG/ABE without Cat., Aluminium	€ 432,00
TCT4101024	slip on, EG/ABE without Cat., Carbon	€ 544,00
TTT4101024	slip on, EG/ABE without Cat., Titanium	€ 544,00



How do you sit on your motorcycle seat? Do you want to change something in your seat?

Then read through the pages of the catalog **SEAT ALTERATION**.
We will change your seat exactly like you want it to be.

You need a Tank bag, Tear Seat Bag, Duffel Bag,
Inside Bag, Universal Bag or Tool Bag?
You can find it under **SOFT BAGS** in the catalog
and online: www.mhornig.com





F800R

built since 2009

798 ccm cylinder Capacity,

power: 87 PS (64 KW)

max. torque 86 Nm

acceleration 0-100kmh: 3,9 Sec.

top speed: over 200 kmh

weight: 199 kg

Our F800R customisation

We have developed and designed some brand new items for your F800R like our windscreens which offer much more protection from wind and rain but still look very sporty.

We thought that the oil cooler is too visible so we designed a bigger oil cooler cover.

Also we developed a small engine spoiler which can be used in combination with the centre stand.

Maybe the most useful item we developed for the BMW F800R is the rear hugger although it is not that visible. It will be mounted with the original chain guard and protects you and your pillion rider from dirt and spread water just like your bike, the exhaust, the collector and much more.





V-Stream Windshield

The V-Stream Windshield set new standards for design, technology and comfort. Made of Quantum/Lexan Polycarbonate which is 10x more scratch-resistant than usual Acrylic. The windscreen will be shipped with everything you need to mount it.

Windshield V-Stream, with homologation and mounting

ArtNo.	Description	Price
Z2424	Clear, Height 40,7cm, Width 38cm	€ 359,00
Z2425	Light tint, Height 40,7cm, Width 38cm	€ 379,00
Z2426	Clear, Height 48cm, width 43cm	€ 359,00



Fork-Crash-Pads

These crash-pads for forks are made of cnc lathed plastic (Nylon). The mounting is made of cnc milled and anodized aluminium.

These crash pads provide additional protection for your fork.

Shipment includes the crash pads (left and right) and the mounting.

ArtNo.	Description	Price
FP100	Fork-Crash-Pads	€ 49,00



Crash-Pads Slider

Our Crash-Pads or Sliders protect your frame, engine and fairing of your motorcycle. This crash pad is designed to fit perfect to your motorcycle. It is made of high-strength milled aluminium and high-strength POM plastic. All our pads are screwed to your motorcycle at least at 2-3 points. The advantage over round crash pads is that these slider can't break or snag on something on the road.

Shipment: Crash Pads for the left and right side with mounting.

ArtNo.	Description	Price
RLBM01-F800R-S	Crash-Pads Slider	€ 239,00

Shift lever extension

Many BMW riders think that their shift lever is a little too thin and doesn't give enough grip when they're shifting.

This enlarger will solve this problem for you as it offers more grip and a more sporty look for your bike. Available in polished or anodized.

ArtNo.	Description	Price
0190	polished	€ 21,40
0390	anodized	€ 21,80
0195	polished with o-rings	€ 23,50
0395	anodized with o-rings	€ 23,90
19x3	O-ring	€ 0,65



Brake pedal enlargement

This brake pedal enlargement is nicely machined of aluminium, knurled and anodized. It is quite simple to install - just slip it on and lock in place with two set-screws.

ArtNo.	Description	Price
0182	anodized	€ 23,80



Sidestand foot enlargement

Feel safer parking your bike on dirt or asphalt with a sidestand foot enlargement. More than 100% bigger contact area. Made of high quality aluminium. Black anodized. Easy to install.

ArtNo.	Description	Price
0722	Sidestand foot enlargement	€ 20,90



Adjustable Foot pegs

The Vario Footrest System (Joint) will be mounted to the motorcycle like the original footpeg.

The adjustable Footrest system consists of 3 parts: Vario Joint, Vario Plate and the Footrest. All Items sold as a set for left and right.



Part 1

The Vario Footrest System (Joint) will be mounted to the motorcycle like the original footpeg. The Joint is silver anodized.



Part 2

The Vario Plate is the part between the Footpeg and the Vario Footrest System (Joint). The Vario Plate is available in 3 length. We recommend 50mm only for the pillion rider.



ArtNo.	Description	Price
051 02 03 00	Driver Vario Footrest System	€ 41,90
051 02 03 10	Pillion rider Vario Footrest System	€ 41,90
051 00 00 23	23mm Vario Plate	€ 44,50
051 00 00 30	30mm Vario Plate	€ 44,90
051 00 00 50	50mm Vario Plate (only pillion rider)	€ 45,90
050 00 04 00 8	Super Grip Footrest black	€ 51,80
050 00 04 00 1	Super Grip Footrest silver	€ 51,70
050 00 01 00 8	Racing Footrest black	€ 29,90
050 00 01 00 1	Racing Footrest silver	€ 29,95

Part 3

The Footpeg will be mounted to the Vario Plate.

The Super Grip Footpegs are available in silver with black rubber.

The Racing Footpegs are available in black or silver.

All Items sold as a set for left and right.



Crash Pads

If your BMW F800R falls over or be involved in a crash these aluminium protection pads will avoid serious damage. The installation is very easy. Shipment: a set for the left and right.

Fits for BMW F800R

ArtNo.	Description	Price
S5080009	Crash Pads	€ 169,00

Crashbars

Our crashbars are made of high-quality steel and are special designed for your BMW F800R. The crashbars are designed to be very robust and allow an equal distribution of the forces so that you and your bike are protected in the best possible way.

You can download the install instructions in the online shop: www.mhornig.com

ArtNo.	Description	Price
TN691	Crashbars	€ 102,80



Mirror Extensions

Our Mirror Extensions are the perfect solutions if you see mainly your shoulders in the mirrors. The mirrors will be moved a few centimetres out in order to improve the view to the rear.

ArtNo.	Description	Price
BK 02	Mirror Extensions 1 Set (M10)	€ 49,95



Main Stand

This main stand is characterized by its accuracy of fit and its stability. It is powder-coated and very instrumental in any little work you have to do on your bike just like changing the brake pads and so on...

ArtNo.	Description	Price
HPS.07.669.10000/B	Main Stand	€ 124,95



Cover

Cover for the fluid reservoir. You simply stick it onto the fluid reservoir and can remove it without residue. It can be fixed with some silicone or something alike.

ArtNo.	Description	Price
0703	anodized	€ 19,90
0704	black anodized	€ 20,90
0705	polished	€ 19,90
s2ml	Silicone 2ml	€ 0,40





Synto brake- and clutch lever

Synto is the name of the 6x adjustable CNC high-precision brake and clutch made of aluminium. Combines elegance and functionality. Handling pure!

- * 6 x adjustable CNC high-precision levers
- * Racing proven Extremely light weight / 60g per lever
- * CNC milled from high tech aeronautical norm aluminium EN 2017
- * Perfect design - convincing finish
- * Brilliant control feeling * Aerodynamic louver
- * Levers ca. 2 cm shorter than original
- * Predetermined breaking point at long version
- * Adjuster colour is always black, only the black lever has a silver adjuster
- * For brake and clutch
- * Including street homologation TÜV part certificate (ABE)



There is a video for this product online: www.mhornig.com

ArtNo.	Description	Price
BH27-KH37-15-11-L	black-silver	€ 218,00
BH27-KH37-17-15-L	red-black	€ 218,00
BH27-KH37-14-15-L	blue-black	€ 218,00



Dash pad

Carbon look - protects this very visible part of your bike from your keys and enhances it's appearance with this scratch resistant, self adhesive pad.

ArtNo.	Description	Price
80072	Dash pad	€ 9,20



LED turning signals

Awesome brightness, fitted in seconds and including electronics on the back of the panel to ensure the correct flash rate. It is the complete turning signal and has a homologation. So it is the first road legal LED for BMW bikes! The LEDs flash yellow.
Sold in pairs (for left and right).

ArtNo.	Description	Price
01006	1 pair of LED turning signals with clear lenses	€ 89,95
01006-g	1 pair of LED turning signals with grey lenses	€ 89,95



Clear indicator lens

Clear indicator lenses. Sold in a set (2 pieces).
And if you want, also single.
With E-Mark, so they are homologated for the EU.
Shipping: 2 lenses incl. orange bulbs.

ArtNo.	Description	Price
CTS-0037	Clear indicator lens	€ 20,90
CTS-0037-g	Grey indicator lens	€ 20,95



Indicator bulb

Either orange or special coated. The special coated one only lights orange when you use the indicator (usually used with transparent lenses).

Single

ArtNo.	Description	Price
BLWB-CBUS	orange coated bulb 12V/10W	€ 2,55
BLWBT-CBUS	special coated bulb 12V/10W	€ 5,99

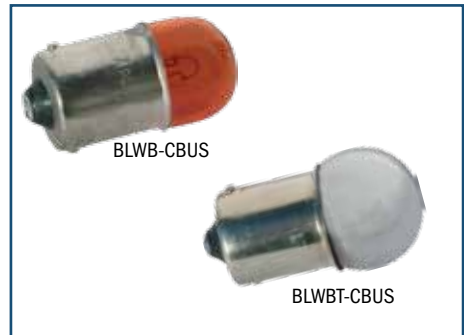

Clear tail light lens

White rear light with long-life LEDs. Super optics, quick installation and with E-mark. Specially adapted to the electrics of the F800R.

The LED rear light gives your motorcycle an entirely new appearance. You need not constantly worry either that the lamp in the rear light is broken, thus making you an accident risk.

ArtNo.	Description	Price
TT.044-0395	Clear tail light lens + LED	€ 59,95
0867	White tail light lens + LED	€ 59,90



Engine Spoiler

This bellypan is made of high quality fibre-glass reinforced synthetic material (GRP) or carbon fibre. Easy to install, can be used with the centre stand. Incl. all fastener and install instruction. The GRP version is black primed.

ArtNo.	Description	Price
40155	GRP Engine Spoiler	€ 219,00
40155-1	Carbon Engine Spoiler	€ 265,00

Tank Centre Panel

This cover for the middle part of the tank is made of carbon fibre which looks very sporty on your BMW F800R. Quite resistant to scratches and so on.

ArtNo.	Description	Price
TAO.002.F800S.K	Tank Centre Panel	€ 299,90



ArtNo. TAO.002.F800S.K
Tank Centre Panel

ArtNo. 40155/40155-1
GPR/Carbon Engine Spoiler

Carbon protectors

alternator cover / clutch cover

Protection against scratches on the clutch cover or alternator cover. At your F800R our carbon protectors provides a remedy.

ArtNo.	Description	Price
616-0035	Carbon protectors clutch cover	€ 59,90
048-0338	Carbon protectors alternator cover	€ 59,90

You can find more
Carbon/GPR attachments
online: www.mhornig.com



ArtNo. 616-0035 alternator cover
ArtNo. 048-0338 clutch cover

GPR Rear Mudguard

This shapely Rear Hugger is made of glass-fibre reinforced plastic (GRP) or carbon fibre and ensures that your legs, the suspension and the rear part of your BMW F800R will stay dry and clean.

The glass-fibre version is black primed.

ArtNo.	Description	Price
40150	GPR Rear Mudguard	€ 179,00
40150-1	Carbon Rear Mudguard	€ 219,00

Carbon Rear Hugger

provides ultimate protection for the rear shock absorber!
Spend less time cleaning, more in riding!

ArtNo.	Description	Price
KHO.002.F800R.K	Kotflügel hinten mit ABE	€ 259,90



ArtNo. 40150/40150-1
GPR/Carbon Rear Mudguard



ArtNo. KHO.002.F800R.K
Carbon Rear Hugger



Remus HexaCone

lighter compared to the original exhaust.
Not only nice for the eyes but also powerful sound - the HexaCone.

Available with two covers: Stainless Steel or Titanium

ArtNo.	Description	Price
4682 085209	Slip-on, Stainless Steel	€ 490,00
4882 085209	Slip-on, Titanium	€ 550,00



**How do you sit on your motorcycle seat?
Do you want to change something?**

Then read through the pages of the catalog
SEAT ALTERATION.

We will change your seat exactly like you want it to be.

**You need a Tank bag, Tear Seat Bag, Duffel Bag,
Inside Bag, Universal Bag or Tool Bag?
You can find it under SOFT BAGS in the catalog
and online: www.mhornig.com**



Weißblaue Geschichten

in den BMW-Sonderausgaben



Erscheint
viermal pro
Jahr, immer zum
Quartalsende:
die MO-Sonder-
ausgabe „BMW
Motorräder“.
Weißblaue
Geschichten
über die
neueste Technik,
Youngtimer,
Klassiker sowie
die Menschen
hinter den
Maschinen

Ein Sonderheft von

MOTORRAD MAGAZIN
MO

www.mo-web.de

Jetzt im Handel

oder einfach direkt beim Verlag bestellen:
online unter www.mo-web.de
oder per E-Mail: bestellservice@mo-web.de
Telefon (0711) 24 89 76-24, Fax 24 89 76-28

Heftpreis 6,20 Euro plus Versandkosten





G650X

built since 2007

652 ccm cylinder capacity

power: 53 PS

max. torque 60 Nm



GPS Mounting G650

Handlebar mounting for 22mm handlebars + Ram-Ball
with M10 x 1,25 thread;

CNC machined for TomTom Rider 2 and Garmin Zumo.

Ram-Ball mount may be used for many other items, too.

Colour: Black



With or without hinge in order to move your navigation
system in the best position.

ArtNo.	Description	Price
NH 1/3 sw 22	GPS Mounting without hinge black	€ 34,95
NH 2/1 sw 22	GPS Mounting with hinge black	€ 44,95



GPS Mounting G650

You need 1x GPS bracket adapter (049-0111) for mounting to the handlebar clamping support
1x GPS Mounting (44004) for mounting your GPS unit to the GPS bracket adapter.

To 44004 fit all BMW Navigators, Garmin Zumo, SPiII, SP26**, 2720, Zumo 550, Zumo 660 and Nüvi series. GPS SP26** & 2720 owners will need to purchase the Garmin Motorcycle Mount.

Maybe you need an extra adapter for a TomTom navigator or our adapter for 1" Ram-Ball when you want to install a Ram-Mount.



ArtNo.	Description	Price
049-0111	GPS bracket adapter	€ 41,90
44004	GPS Mounting	€ 38,90
tomtom-Ad	Adapter for TomTom Rider Incl. screws for mounting in the GPS mount and the TomTom holder.	€ 9,55
tomt-Ad Ed 2	Adapter for TomTom 2nd Edition Incl. screws for mounting in the GPS mount and the TomTom holder.	€ 14,90
ram-1zoll	Adapter for 1" Ram-Ball	€ 29,90

Brake pedal enlargement

This special part is made of extremely handy aluminium and cares for safe braking. It gets mounted with two screws, u-screws, nut and hulls which are all yet with the enlargement. For all BMW G650X bikes.

ArtNo.	Description	Price
0126	Aluminium	€ 15,90
0126-1	anodized	€ 16,90



Frame cover

These covers (left and right) for the open tubes in the frame are made of aluminium and available in two different versions.

For all BMW G650X bikes.

ArtNo.	Description	Price
0120	1 Set polished	€ 19,90
0220	1 Set anodized	€ 19,95





Crashbars

Our crashbars are made of high-quality steel and are specially designed for your G650X. The crashbars are designed to be very robust and provide an equal distribution of the forces so that you and your bike are protected in the best possible way.

Crashbars offer a very good protection but they can reduce cornering angles.

For BMW G650X Challenge, Moto & Country

ArtNo.	Description	Price
SBL07.629.100	Crashbars black	€ 149,95



20 mm Handlebar Riser

We offer a handlebar riser for your G650X, which you will find quite easy to fit. It provides a more upright and relaxed seating position. This reduces tension in the shoulders and wrists. And the handlebar riser is also helpful when racing, because the more upright standing position means both your endurance and concentration are improved. Also, bike control is enhanced.

Not for models with ABS.

ArtNo.	Description	Price
049-0109	20 mm Handlebar Riser	€ 21,90



Lifter

Our front lifter fits for BMW F650GS twin, all F800 and G650X bikes. It is specially made for the lowered F650GS twin. It is perfect for care, overwinter, change wheels and servicing. Made of steel, zinc-plated and quality „Made in Germany“.

ArtNo.	Description	Price
Lifter010	Lifter	€ 75,90



Hand Protectors

Hand Protectors BMW G650X all models without ABS

- Optimum lever protection (brake and clutch levers)
- Optimum protection for your hands
- Robust even at high speeds
- Good wind deflection
- Elegant design enhances the enduro looks

Note: Adjust only for models without ABS.

Hand protector colours: black

ArtNo.	Description	Price
040-6691	Set Hand Protectors black	€ 79,90
040-7301	Set Spoiler	€ 20,90

Beak

In order to give your BMW G650X Moto a Hypermoto Look. Made of high quality glass fibre and black primed. Easy to mount incl. all mountings and install instruction.

ArtNo.	Description	Price
40116	GPR Beak	€ 149,00



Rear mudguard

Fits between the rear shock and wheel. Designed specifically keep road debris & water from the backs of riders legs, shock, gearbox, battery and centre stand.

ArtNo.	Description	Price
40098	GPR Rear mudguard black primed	€ 149,00



Carbon small exhaust heat shield

The small exhaust heat shield not only fulfils its purpose, it also imparts a thoroughbred appearance to your Xchallenge. Its made from light carbon. Alongside its primary function, it also protects the Lambda probe. As opposed to the OEM heat shield, it combines top-quality materials and a functional look with a reduction in weight.

- simple, uncomplicated exchange for the original shield
- uses the original screws

ArtNo.	Description	Price
049-0160	Carbon small exhaust heat shield	€ 59,90



Carbon exhaust heat shield big

The big exhaust heat shield not only fulfils its purpose, it also imparts a thoroughbred appearance to your Xchallenge. Its made from light carbon. As opposed to the OEM heat shield, it combines top-quality materials and a functional look with a reduction in weight.

- simple, uncomplicated exchange for the original shield
- uses the original screws

ArtNo.	Description	Price
049-0170	Carbon big exhaust heat shield	€ 79,95





Suspensions

Wilbers Quality:

Typ 640:

* Continuously adjustable preload

* Adjustable rebound

* Raising ride height

* Hydraulic preload adjustment

extra for Typ 642:

* piggyback reservoir

ArtNo.	Description	Price
640-g650x	Suspensions Typ 640	€ 499,00
642-g650x	Suspensions Typ 642	€ 799,00
625-046-00	Hydraulic preload adjustment	€ 199,00

Our Wilbers suspensions will be specially adjusted for you!

Because of this please inform us about your weight with clothes and helmet, the weight of your luggage (perhaps pillion rider), where you ride (street, off-road, race) and how you ride (sport, touring, and so on) in the „comment“ of your order.



Fork Springs

Our progressive Wilbers fork springs are especially developed for your requirements and your BMW G650X.

They ensure improved comfort and higher safety.

Will be adjusted to the length of our suspensions.

Fade resistant. With ABE.

ArtNo.	Description	Price
600-32*	1 Set Progressive fork springs	€ 199,00
610-010-00	1L Wilbers Oil (you need 2L)	€ 19,90



Aluminium

Remus Revolution

Free the real power of your G650X with the new Remus Revolution. A much better torque curve combined with the perfect single cylinder sound provide pure driving pleasure.

With catalytic converter and EG-homologation.

Slip-on = Exhaust

Complete = Exhaust + Exhaust Manifold

ArtNo.	Description	Price
098142 084507	Revolution, Slip on, Aluminium	€ 627,00
098842 084507	Revolution, Slip on, Titanium	€ 756,00
018142 084507	Revolution, Exhaust, Aluminium	€ 841,00
018842 084507	Revolution, Exhaust, Titanium	€ 970,00



You need a Tank bag, Tear Seat Bag, Duffel Bag,
Inside Bag, Universal Bag or Tool Bag?
You can find it under SOFT BAGS in the catalog
and online: www.mhornig.com

Crashbars

Our crashbars are made of high-quality steel and are specially designed for your G650GS. The crashbars are designed to be very robust and allow an equal distribution of the forces so that you and your bike are protected in the best possible way.

Crashbars offer a very good protection but they can reduce the cornering angle.

ArtNo.	Description	Price
SBL.07.775. 10000/B	Set Crashbars black G650GS	€ 149,95



Speedometer trim

This polished ring for your speedometer is an optical improvement for your G650GS. Just stick on with glue or some silicone. May be removed without residue. Consists of a set of both rings.
If you have no silicone you can also order our high quality silicone which is already filled in the volume you need and easy to dose.

ArtNo.	Description	Price
0402	Polished	€ 19,90
0402-1	Natural anodized	€ 23,90
s2ml	Silicone 2ml	€0,40



Side stand foot enlargement

Feel safer parking your bike on dirt or asphalt with a side-stand foot enlargement. More than 100% bigger contact area. Made of high quality aluminium.
Black anodized.
Easy to install.

ArtNo.	Description	Price
0721	Sidestand foot enlargement	€ 19,90



Touring screen

The touring shield for BMW G650GS has the same shape as the original, but with an additional raised wind deflector about 5-7 cm high at the top, covering the entire width. This deflects the wind over the rider and allows a relaxed ride, particularly on longer trips.
Length: 335mm

ArtNo.	Description	Price
4025066131792	clear	€ 79,90
4025066131808	smoke grey	€ 79,90
4025066131815	black	€ 79,90





K1200 RS & GT

built from 1997 to 2004/since 2002

1171 ccm cylinder capacity

power: 98/130 PS

max. torque 117 Nm

Rear wheel centre cover

A cover made of aluminium - with emblem.

Just put it into the hole over the screw in the wheel.

An o-ring keeps this part firmly in place.

Note: The Rear wheel centre cover does not fit when the bolt in the middle protrudes further than the wheel.

ArtNo.	Description	Price
0204	polished	€ 20,90
0204-1	anodized	€ 21,50



Key holder with emblem

Useful key holder made of knurled aluminium, polished on top, with our emblem.

Just slot in the „Emergency key“ and fix with a setscrew.
0076 : Also possible to hook in a carabiner.

ArtNo.	Description	Price
0075	polished without eye	€ 19,90
0076	polished with eye	€ 28,50



Brake pedal enlargement

This brake pedal enlargement is nicely machined of aluminium, knurled and anodized.

It is quite simple to install - just slip it on and lock in place with a set-screw.

ArtNo.	Description	Price
0100	anodized	€ 24,60



Speedometer trim

Trim rings for the speedometer, the revolution counter, the temperature and fuel gauges are a optical Improvement for your K 1200 RS & GT.

You simply stick them to the speedometer e.g. with silicon and you can remove them without any residue.

All rings are available singly.

ArtNo.	Description	Price
0404	1 Set polished	€ 52,90
0408	1 Set anodized	€ 56,90
s2ml	Silicone 2ml	€ 0,40





Shift lever extension

Many BMW riders think that their shift lever is a little too thin and doesn't give enough grip when they're shifting. This enlarger will solve this problem for you as it offers more grip and a more sporty look for your bike. Available in polished or anodized.

ArtNo.	Description	Price
0190	polished	€ 21,40
0390	anodized	€ 21,80
0195	polished with o-rings	€ 23,50
0395	anodized with o-rings	€ 23,90
19x3	O-Ring	€ 0,65



Foot brake fluid reservoir cover

Cover for the foot brake fluid reservoir CNC machined of aluminium, polished.

Image shows K1200R. But it is also visible on: K1200RS without Int. ABS.

ArtNo.	Description	Price
0706	polished	€ 19,90
0706-1	anodized	€ 20,90
s2ml	Silicone 2ml	€ 0,40



Swing arm pivot cover

Good looking dirt-protection.

We sell the swing arm pivot covers in a Set.

The foot pegs must be mounted in low position.

ArtNo.	Description	Price
0345	1 Set polished	€ 39,50
0445	1 Set anodized	€ 40,90



Mirror Extensions

Our Mirror Extensions are the perfect solutions if you see mainly your elbow in the mirrors. The mirrors will be moved 25 mm up to improve the view to the rear.

Fits only the mirror you can see above.

ArtNo.	Description	Price
BK 06	Mirror Extensions 1 Set	€ 49,95



Oil filler plug with emblem

This oil filler plug is made of aluminium and available in polished or anodized. Use an Allen tool size 3 (which should usually belong to your BMW tools) in order to close and open the oil filler plug.

ArtNo.	Description	Price
0470	polished	€ 25,00
0475	anodized	€ 25,00
10013	O-ring	€ 1,60



Oil filler plug

Oil filler plug with Allen tool. Very nice looking and brilliant protection. Use an Allen tool size 6 (usually found in your BMW tools) in order to close and open the oil filler plug.

ArtNo.	Description	Price
0460	polished	€ 19,80
0465	anodized	€ 19,90
10013	O-ring	€ 1,60





Paralever pivot cap

Effective prevention of dirt is guaranteed by this paralever pivot cap.

Highest quality and a perfect look anodized aluminium.

ArtNo.	Description	Price
0070	anodized	€ 12,90



Frame cover

Nice covers for the frame of all BMW K1200RS, K1200GT and K1200LT. Delivered as a set. Available in polished and anodized.

ArtNo.	Description	Price
0350	1 Set polished	€ 19,95
0450	1 Set anodized	€ 21,95



Sidestand foot enlargement

Feel safer parking your bike on dirt or asphalt with a side stand foot enlargement.

More than 100% bigger contact area.

Made of high quality aluminium.

Black anodized.

Easy to install.

ArtNo.	Description	Price
0714	Sidestand foot enlargement	€ 25,90



Oil cooler protection

Perfect protection for your oil cooler which looks quite nice and is designed of high-quality aluminium. The lattice is formed in a special way to be very robust and keeps little insects or dirt off the oil cooler.

Install instructions and scratch protection are included.

Fits for K1200RS MY 2001-* and K1200GT till 2005.

ArtNo.	Description	Price
0604	Oil cooler protection	€ 29,90
s10ml	Silicone 10ml	€ 0,80

GPS Mounting

Fast, easy mounting is possible with our new GPS Mount for BMW K1200RS & GT 2001 or newer. The windscreen can still be used in all positions and you always read your GPS without looking away from the street.

No vibrations!

For all BMW Navigators and Garmin SPIII & SP26**, 2720, Zumo 550, Zumo 660 and Nüvi series. SP26** & 2720 owners need the Garmin Motorcycle Mount.

Colour: Anodized Silver

The Zumo and TomTom Navigator can also be mounted with the correct adapter.

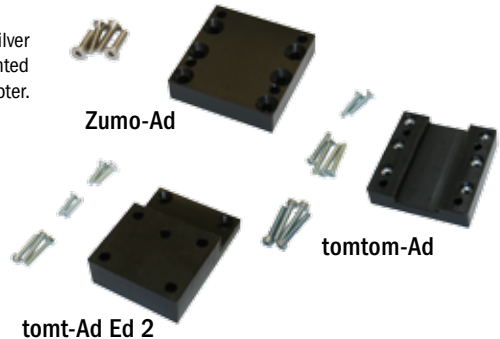

ArtNo.	Description	Price
44003	GPS Mounting	€ 89,90
Zumo-Ad	This adapter is made for all Garmin SPIII, SP26**, 2720 & Zumo. With this adapter the GPS is 12mm closer to you and it can be dislocated 7,5mm or 15mm higher or lower as usual. You need this option for the Zumo's bus bar. Made of black Pom incl. all screws.	€ 9,95
tomtom-Ad	Adapter for TomTom Rider Incl. screws for mounting the GPS mount and the TomTom holder.	€ 9,55
tomt-Ad Ed 2	Adapter for TomTom 2nd Edition Incl. screws for mounting in the GPS mount and the TomTom holder.	€ 14,90
ram-1zoll	Adapter for 1" Ram-Ball	€ 29,90

You can find the latest products and bargains
online: www.mhornig.com



Hardware kit

These stainless and polished screws look great and remain that way for years. Complete kit including the screws and all instructions needed.

ArtNo.	Description	Price
70040	K1200RS until 2000 model (32 piece)	€ 16,50
70045	K1200RS & GT from 2001 model (44 piece)	€ 17,90
0421005	transp.Shim Ø 5,3mm	€ 0,14
0421006	transp.Shim Ø 6,4mm	€ 0,14



Chrome cap I

The chrome caps for the gear oil filler screw are an optical improvement for your BMW.

You simply push them on. The caps fit into the gear oil filler screw with Allen head and will fit any other screws with the same Allen size.

ArtNo.	Description	Price
0500	Big chrome caps	€ 4,25
0501	Small chrome caps	€ 3,75



Chrome cap II

Chrome cap II was created for covering the gear oil filler screw.

Like cap I it is just pushed on and fits perfectly.

ArtNo.	Description	Price
0502	Chrome cap II	€ 3,80



Chrome cap V

The chrome cap V for the speedometer adjustment is an optical improvement for your BMW.

You simply stick it on e.g. with Uhu or Silicon.

If you have no silicone at home you can also order our high quality silicone which is pre-filled in the volume you need and easy to dose.

ArtNo.	Description	Price
0508	Chrome cap V	€ 1,70
s2ml	Silicone 2ml	€ 0,40

S/S screws

Brake fluid - & clutch reservoir
get a new look with these 4x S/S screws

70070: For all (elderly) Bikes with a hydraulic brake
and no hydraulic clutch

70075: For all (newer) Bikes with a hydraulic brake
and a hydraulic clutch

ArtNo.	Description	Price
70070	4 x M5x16	€ 3,95
70075	4 x M4x16	€ 3,95



Clear lens + LED

Far brighter than the standard set up!

Fitted in seconds by anyone.

Features up to 24 red high intensity LEDs

ArtNo.	Description	Price
40106-01	Without Integral ABS	€ 84,95
40106-02	With integral ABS (with or without cruise control)	€ 89,95





Clear indicator lens front

Fits the K1200RS & GT 1997 - 2001 models.

For easy exchange. Sold in pairs, amber bulbs included.

ArtNo.	Description	Price
WLB-58	1 Set clear indicators	€ 49,90
WLB-58-S	1 Set black indicators	€ 47,90



Clear indicator lens front

Clear indicator lens for the front of your K1200RS & GT.

For the left and right with orange bulbs.

Fits the 2001 model or newer.

With E-mark.

ArtNo.	Description	Price
7 672 159	left	€ 46,90
7 672 160	right	€ 46,90



Clear indicator lens

These clear indicator lenses give your BMW a quite sporty look.

Supplied as pairs but if you want, also as single items.

Amber bulbs included!

ArtNo.	Description	Price
L30103	1 Set Clear indicator lens	€ 18,95
L30103-g	1 Set Grey indicator lens	€ 18,95



LED turning signal

Awesome brightness, fitted in seconds and including electronics on the back of the panel to ensure the correct flash rate.

It is the complete turning signal and has a homologation.

So it is the first road legal LED for BMW bikes!

The LEDs flash yellow. Sold in pairs.

ArtNo.	Description	Price
0917	1 pair with clear lenses	€ 99,95
0917-g	1 pair with grey lenses	€ 99,95

WP Suspension front & rear

Fit for K1200RS MY 97-*

Our WP suspensions will be specially adjusted for you! Because of this please inform us about your weight with clothes and helmet, the weight of your luggage (perhaps pillion rider), where you ride (street, off-road, race) and how you ride (sport, touring, and so on) in the „comment“ of your order.

The Fusion as well as the Emulsion suspension can be combined with the hydraulic preload adjustment. (productnr. /02)

For extra charge you can choose any spring colour you like.

High/Low speed compression separately adjustable, each 16 times (256 possibilities) (only Spin and Fusion)

Suspension rear: adjustable rebound preload adjuster

Suspension front: adjustable rebound, 16 positions

For riders wanting the upmost from their machine
 Exceptional cooling properties due to the use of heat diverting aluminium alloys, therefore constant shock absorption and longer life
 Lightweight through use of high quality materials
 Adjustable length is standard
 Recognised safety certificate

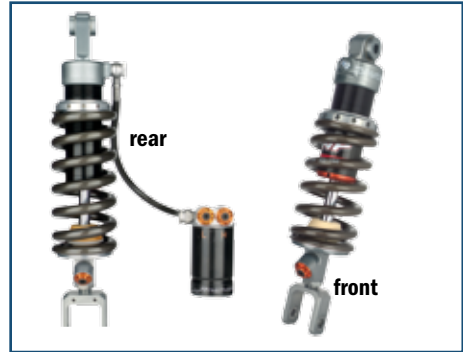

ArtNo.	Description	Price
17.06.R9.18 /X9.73	Emulsion suspension rear	€ 549,00
17.06.R8.18 /X8.72	Fusion suspension with reservoir fixed by a steel flex	€ 849,00
/02	Hydraulic preload adjustment	€ 229,00
17.06.R9.20 /X9.73	Emulsion suspension front	€ 549,00



Alu

Remus Revolution

K 1200 RS & GT 97 model or newer Type BMW589

72/96 kW

Exhaust system incl. front exhaust silencer left, Revolution, EG/ABE

Perfect Looking, quick and easy Mounting, less Weight, more Power, more Torque, deep and throaty Sound combined with ABE (European Homologation) Real riding pleasure!

ArtNo.	Description	Price
018102 088097L	Without catalytic converter, EG/EEC, Aluminium	€ 987,00
018802 088097L	Without catalytic converter, EG/EEC, Titanium	€ 1102,00





Dash pad

Dash pad in carbon look - protects this very visible part of your bike from key scratches and enhances its appearance. Scratch resistant, self adhesive pad.

ArtNo.	Description	Price
80066	Dash pad K1200GT	€ 16,80
80065	Dash pad K1200RS	€ 16,60



Carbon Rear Hugger

Provides ultimate protection for the rear shock absorber! Spend less time cleaning, more time riding!
Fits K 1200 RS & GT.
With ABE for 1997 model or newer.

ArtNo.	Description	Price
050.10.12	Carbon Rear Hugger	€ 219,90



High Windscreen

The K1200GT screen has an additional upward tilted airfoil over its entire width to deflect wind pressure away from the rider, ensuring an easy, relaxing ride, even on long trips.

Height 50cm

Fits for RS from 01 model.

For the K1200RS 97 - 00 we also offer a 46 cm high windscreen. Similar to the picture but with a smaller spoiler.

Note: delivery time about 14 days.

ArtNo.	Description	Price
4663766 3115	GT screen for K1200RS 2001 model or later	€ 134,90
2347650	GT screen for K1200RS 97 - 00	€ 132,60

Windscreen K1200RS 2001-2004

The V-Stream Windshield set new standards for design, technology and comfort. Made of Quantum/Lexan Polycarbonate which is 10x more scratch-resistant than usual

Acrylic. The windscreen will be shipped with everything you need to mount it.

Windshield V-Stream, with homologation



ArtNo.	Description	Price
Z2213	Light tint, Height 53cm	€ 269,00
Z2214	Dark tint, Height 33cm	€ 229,00
Z2215	Light tint, Height 33cm, width 44cm	€ 279,00

**How do you sit on your motorcycle seat?
Do you want to change something?**

Then read through the pages of the catalog

SEAT ALTERATION.

We will change your seat exactly like you want it to be.

**You need a Tank bag, Tear Seat Bag, Duffel Bag,
Inside Bag, Universal Bag or Tool Bag?
You can find it under SOFT BAGS in the catalog
and online: www.mhornig.com**





K1200 R & R Sport

built since 2005

1157 ccm cylinder capacity

power: 163 PS

max. torque 127 Nm

K1200R Customisation

This one-off special in 'Rockster Orange' with special fairing parts is a special show bike and won't be put into production.

We looked at the standard K1200R with its asymmetrical look of the air ram on one side only, and constructed a very complex closed-in front with integrated indicators and two air inlets.

Virtually no standard fairing parts exist on this bike, most have been either modified or are completely new constructions, such as the short engine spoiler with 'wings' reaching up to the tank.

Even the rear has been modified with a pillion seat cover reaching further rearwards for a more aggressive look.

Some of our series parts like the crash pads, bar end weights, frame protectors and side stand enlarger were also used.

To finish it off we also used a selection of our Carbon fibre parts.





Superbike handlebars

These handlebars create a new sporty looking and improve the handling of your bike. The mounting kit is made of high quality aluminium and the bars are especially designed for the BMW K1200R & K1200R Sport. Width of the handlebar is 770mm.

ArtNo.	Description	Price
AC-K1200R	Superbike handlebars	€ 469,00



Frame Cover

Cover for the hole above the swing arm journal. Available in polished, anodized and black anodized version.

ArtNo.	Description	Price
0352	polished	€ 12,20
0453	anodized	€ 12,60
0454	black anodized	€ 12,95



Cover

Covers for the fluid reservoirs. You simply stick them onto the fluid reservoirs. Can be removed them without residue. Made of high quality aluminium. They are sold in a set of two.

ArtNo.	Description	Price
0700	1 Set polished	€ 39,80
0701	1 Set anodized	€ 39,90
0702	1 Set black anodized	€ 39,95
s2ml	Silicone 2ml	€ 0,40



GPS Mounting

Plug for BMW handlebars with inside diameter of 16mm. Just insert the CNC machined plug in the open part of the handlebar (usually closed with a plastic plug). The plug will stay in place thanks to an expansion fastener. Almost any navigation system can be fixed on the Ram-ball of this GPS Mounting.

Colour: Black

ArtNo.	Description	Price
NH 3/1	Black Plug (Ram-ball)	€ 34,95

Speedometer cover

In order to customize your BMW K1200R's & K1200R Sport & K1300R's speedo. Made of milled or laser cutted aluminium, polished or anodized. Very easy to mount with usual silicon. An install instruction is included in the set for the speedo and the revolution counter.

ArtNo.	Description	Price
0411	1 Set polished	€ 74,90
0411-1	1 Set anodized	€ 74,95
s10ml	Silicone 10ml	€ 0,80



Protection

If your K1200R & R Sport falls over or be involved in a crash these aluminium protection pads will avoid serious damage.

You install them in place of the original plastic pads.
Shipment: a set for the left and right.

ArtNo.	Description	Price
0800	1 Set polished	€ 49,00
0801	1 Set anodized	€ 49,90



Rear wheel centre cover

Rear wheel centre lug cover with emblem.

The holes in the covers serve for cooling!
The lower temperature is based on the special angles of the drillings, which cause a little bit more concentrated air flow, but don't be worried it doesn't affect the drivability of your BMW.

ArtNo.	Description	Price
0116	polished	€ 61,90
0216	anodized	€ 62,90
0316	black anodized	€ 63,40





Main Stand

With EG/ABE. This main stand is characterised by its accuracy of fit and stability. It is very simple to fit on your bike - just like changing the brake pads and so on. When you use an engine spoiler e.g. for the K1200S slight modifications are required. Instructions are included.

For BMW K1200R and 2005 model or newer.

ArtNo.	Description	Price
HPS.07.360.100	Main Stand	€ 134,95



Sidestand foot enlargement

Feel safer parking your bike on dirt or asphalt with a side stand foot enlargement.

More than 100% larger contact area.

Made of high quality aluminium.

Black anodized.

Easy to install.

ArtNo.	Description	Price
0707	Sidestand foot enlargement	€ 23,90



Bar-end weights

These bar-end weights made of Stainless steel or aluminium show that BMW riders are aware of function and form.

Article number: 0805 stainless steel 220 gram each

Article number: 0806 aluminium 84 gram each

Shipment: 2 end weights, 2 screws.

ArtNo.	Description	Price
0805	1 Set Stainless steel	€ 32,90
0806	1 Set Aluminium anodized	€ 25,90



Axle pivot Cover

This cover for the axle pivot for all new R1200, K1200 and K1300 bikes gives a nice looking finish to the rear end and gives your motorcycle a classy look.

ArtNo.	Description	Price
0072	polished	€ 21,90
0172	anodized	€ 21,90
0272	black anodized	€ 21,90

Adjustable Foot pegs

The Vario Footrest System (Joint) will be mounted to the motorcycle like the original footpeg.

The adjustable Footrest system consists of 3 parts: Vario Joint, Vario Plate and the Footrest. All Items sold as a set for left and right.



Part 1

The Vario Footrest System (Joint) will be mounted to the motorcycle like the original footpeg. The Joint is silver anodized.



Part 2

The Vario Plate is the part between the Footpeg and the Vario Footrest System (Joint). The Vario Plate is available in 3 length. We recommend 50mm only for the pillion rider.



ArtNo.	Description	Price
051 02 03 00	Driver Vario Footrest System	€ 41,90
051 02 03 10	Pillion rider Vario Footrest System	€ 41,90
051 00 00 23	23mm Vario Plate	€ 44,50
051 00 00 30	30mm Vario Plate	€ 44,90
051 00 00 50	50mm Vario Plate (only pillion rider)	€ 45,90
050 00 04 00 8	Super Grip Footrest black	€ 51,80
050 00 04 00 1	Super Grip Footrest silver	€ 51,70
050 00 01 00 8	Racing Footrest black	€ 29,90
050 00 01 00 1	Racing Footrest silver	€ 29,95

Part 3

The Footpeg will be mounted to the Vario Plate. The Super Grip Footpegs are available in silver with black rubber.

The Racing Footpegs are available in black or silver.

All Items sold as a set for left and right.

Brake Pedal Enlargement

It is nicely machined of aluminium and natural anodized.

The surface is slotted in order to avoid slipping. This enlargement simply slips on and is held in place with two set-screws.

ArtNo.	Description	Price
0102	Brake Pedal Enlargement	€ 30,50



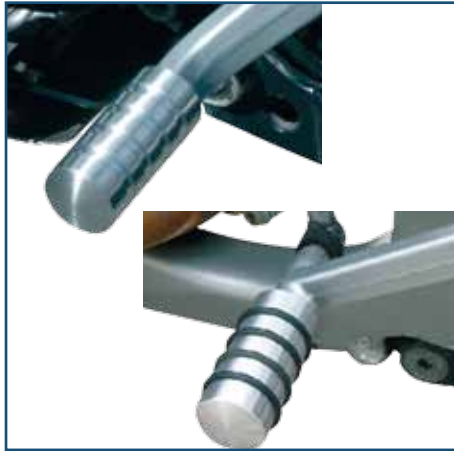

Shift lever extension

Many BMW riders think that their shift lever is a little too thin and doesn't give enough grip when they're shifting. This enlarger will solve this problem for you as it offers more grip and a more sporty look for your bike. Available in polished or anodized.

ArtNo.	Description	Price
0190	polished	€ 21,40
0390	anodized	€ 21,80
0195	polished with o-rings	€ 23,50
0395	anodized with o-rings	€ 23,90
19x3	O-Ring	€ 0,65



Foot brake fluid reservoir cover

Cover for the foot brake fluid reservoir CNC machined of aluminium.

If you have no silicone you can also order our high quality silicone which is pre-filled in the volume you need and easy to dose.

ArtNo.	Description	Price
0706	polished	€ 19,90
0706-1	anodized	€ 20,90
s2ml	Silicone 2ml	€ 0,40



Front lifter

It is perfect for care, overwinter and servicing.

Made of steel 35x35mm, zinc-plated and quality „Made in Germany“.

ArtNo.	Description	Price
2039-80II	Front lifter	€ 98,90



Back lifter

Slide the rubber coated pipe of the Back lifter in the final drive of your BMW and lift it up. Easy to use by one person and very stable support for the bike.

Made of high quality steel. Diameter 42mm, zinc-plated. The diameter of the rubber is 52,5mm.

ArtNo.	Description	Price
BT.heck-lifter	Back lifter	€ 89,90



Synto brake- and clutch lever

Synto is the name of the 6x adjustable CNC high-precision brake and clutch made of aluminium. Combines elegance and functionality. Handling pure!

- * 6 x adjustable CNC high-precision levers
- * Racing proven Extremely light weight / 60g per lever
- * CNC milled from high tech aeronautical norm aluminium EN 2017
- * Perfect design – convincing finish
- * Brilliant control feeling * Aerodynamic louver
- * Levers ca. 2 cm shorter than original
- * Predetermined breaking point at long version
- * Adjuster colour is always black, only the black lever has a silver adjuster * For brake and clutch
- * Including street homologation TÜV part certificate (ABE)

There is a video for this product online: www.mhornig.com



ArtNo.	Description	Price
BH27-BKH1-15-11-L	black-silver	€ 218,00
BH27-BKH1-17-15-L	red-black	€ 218,00
BH27-BKH1-14-15-L	blue-black	€ 218,00



Mirror Extensions

Our Mirror Extensions are the perfect solutions if you see mainly your shoulders in the mirrors. The mirrors will be moved a few centimetres out in order to improve the view to the rear.

For K1200R & R Sport.

ArtNo.	Description	Price
BK 02	Mirror Extensions	€ 49,95



Crashbars

Our crashbars are made of high-quality steel and are special designed for your K1200R, R Sport. Crashbars are designed to be very robust and allow for an equal distribution of forces in a crash. You and your bike are protected in the best possible way.

Crashbars offer a very good protection but they can reduce the cornering angle.

ArtNo.	Description	Price
SBL07.413.100/B	Crashbars black	€ 154,95
SBL07.413.100/S	Crashbars silver	€ 149,95



Fork-Crash-Pads

These crash-pads for forks are made of cnc lathed plastic (Nylon). The mounting is made of cnc milled and anodized aluminium.

These crash pads provide additional protection for your fork.

Shipment includes the crash pads (left and right) and the mounting.

ArtNo.	Description	Price
FP100	Fork-Crash-Pads	€ 49,00



Crash-Pads Slider

Our Crash-Pads or Sliders protect your frame, engine and fairing of your motorcycle. This crash pad is designed to fit perfect to your motorcycle. It is made of high-strength milled aluminium and high-strength POM plastic. All our pads are screwed to your motorcycle at least at 2-3 points. The advantage over round crash pads is that these slider can't break or snag on something on the road.

Shipment: Crash Pads for the left and right side with mounting.

ArtNo.	Description	Price
RLBM03	Crash-Pads Slider	€ 279,00

Clear tail light

The clear tail light is available with a red bulb or LED and a grey tail light is available with LED.

Both LEDs have an E-mark and are very easy to install and fit perfectly.

ArtNo.	Description	Price
WLL-87-L	Clear lens with LED (not for model 08-)	€ 89,95
WLL-87-L-g	Grey lens with LED (not for model 08-)	€ 89,95



Clear indicator lens

Clear indicator lenses. Sold in a set (2 pieces).

And if you want, also single.

With E-Mark, so they are homologated for the EU.

Shipping: 2 lenses incl. orange bulbs.

ArtNo.	Description	Price
CTS-0037	Clear indicator lens	€ 20,90
CTS-0037-g	Grey indicator lens	€ 20,95



LED turning signals

Awesome brightness, fitted in seconds and including electronics on the back of the panel to ensure the correct flash rate. It is the complete turning signal and has a homologation. So it is the first road legal LED for BMW bikes! The LEDs flash yellow.

Sold in pairs (for left and right).

ArtNo.	Description	Price
01006	1 pair of LED turning signals with clear lenses	€ 89,95
01006-g	1 pair of LED turning signals with grey lenses	€ 89,95



Windscreen ZTechnik

In order to create a more comfortable ride, other manufacturers offer extra-tall windshields or spoiler tops to try to lift the air stream. But ZTechnik designed, for the first time ever, a windshield with contours calculated and adjusted to manage the riding environment.

Windshield, tinted, with homologation and mounting kit, Height 41 cm, Width 52 cm

ArtNo.	Description	Price
Z2225	Height 41 cm, Width 52 cm	€ 289,00





Carbon Front mudguard

This front mudguard is an optical improvement for your BMW K1200R & R Sport.

Made of carbon fibre.

ArtNo.	Description	Price
KVO.001.K120R.K	Front mudguard K1200R	€ 299,90
KVO.002.K120S.K	Front mudguard K1200R Sport	€ 229,90



Carbon Front mudguard PowerCup Version

Short and sporty fender for K1200R from the Powercup-series.

Also made of carbon fibre.

ArtNo.	Description	Price
KVO.050.K120R.K	Front mudguard PowerCup Version	€ 219,90



Carbon Reservoir-Cover Kit

Cover Kit for reservoirs of brake and clutch fluid reservoirs with carbon surface. The carbon fibre parts are precisely shaped and are to be fitted by glue.

ArtNo.	Description	Price
400.10.40	1 Set Reservoir-Covers	€ 59,00
s2ml	Silicone 2ml	€ 0,40



Carbon Exhaust cover front

Beautiful high quality carbon fibre. Covers the joint between collector and silencer.

Only for the original exhaust.

Available for K1200R & R Sport.

ArtNo.	Description	Price
ABV.006.K120S.K	Exhaust cover front	€ 149,90

Carbon Heel guards

Heel guards made of carbon fibre.
A small and highly visible enhancement.
Very easy to install.
Sold in a set for the left and right.

ArtNo.	Description	Price
FSO.004.K120S.K	1 Set Heel guards	€ 149,90



Carbon Battery Cover

Fuel tank cover carbon middle part
for BMW K1200R & R Sport.

ArtNo.	Description	Price
BAH.004.K120R.K	Battery Cover	€ 139,90



Carbon Rear Hugger

Provides ultimate protection for the rear shock absorber.
Spend less time cleaning, more time riding!

Fits K 1200 S, R & R Sport with tire sizes
180/55er and 190/50er.

ArtNo.	Description	Price
KHO.001.K120S.K	Rear Hugger	€ 269,90

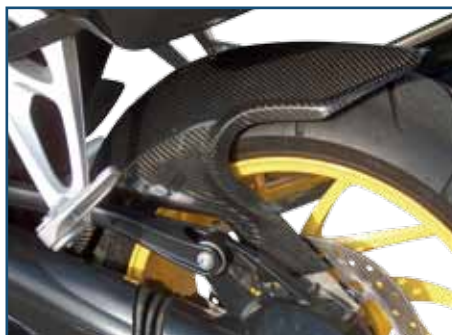

Carbon Rear Light Cover

This rear light cover is made of high quality carbon fibre
and available in two versions:
with or without holes for handgrips.

ArtNo.	Description	Price
RHO.007.K120R.K	Rear Light Cover (with holes)	€ 339,90
RHO.008.K120R.K	Rear Light Cover (without holes)	€ 339,90





Dash pad

Carbon look - protects this very visible part of your bike from your keys and enhances its appearance with this scratch resistant, self adhesive pad.

ArtNo.	Description	Price
80067	Dash pad	€ 14,55



Carbon Clutch Cover

Small, but very strong clutch protector. Made of carbon fibre.

ArtNo.	Description	Price
KD0.016.K120S.K	Clutch Cover	€ 89,90

You must send your seat to us!

How do you sit on your motorcycle seat?
Do you want to change something?

Then read through the pages of the catalog
SEAT ALTERATION.

We will change your seat exactly like you want it to be.



You need a Tank bag, Tear Seat Bag, Duffel Bag, Inside Bag, Universal Bag or Tool Bag?

You can find it under **SOFT BAGS** in the catalog and online: www.mhornig.com

Remus HexaCone

More than 4kg lighter compared to the original exhaust.

Not only nice for the eyes but also powerful sound - the HexaCone.

Available with three covers:

High-grade Steel, Carbon Fibre or Titanium



ArtNo.	Description	Price
154682 088305	High-grade Steel incl. Cat.	€ 657,00
154882 088305	Titanium incl. Cat.	€ 719,00

You can find exhaust from Remus and BOS
and suspensions from Öhlins
online: www.mhornig.com

WP Suspension front & rear

Our WP suspensions will be specially adjusted for you! Because of this please inform us about your weight with clothes and helmet, the weight of your luggage (perhaps pillion rider), where you ride (street, off-road, race) and how you ride (sport, touring, and so on) in the „comment“ of your order.

The Fusion as well as the Emulsion suspension can be combined with the hydraulic preload adjustment. (productnr. /02)

You can choose any spring colour you like.

Suspension rear: adjustable rebound preload adjuster

High/Low speed compression separately adjustable, each 16 times (256 possibilities) (only Spin and Fusion)

Suspension front: preload adjuster, 16 positions.

For riders wanting the upmost from their machine Exceptional cooling properties due to the use of heat diverting aluminium alloys, therefore constant shock absorbtion and longer life

Lightweight through use of high quality materials
Adjustable length is standard
Recognised safety certificate

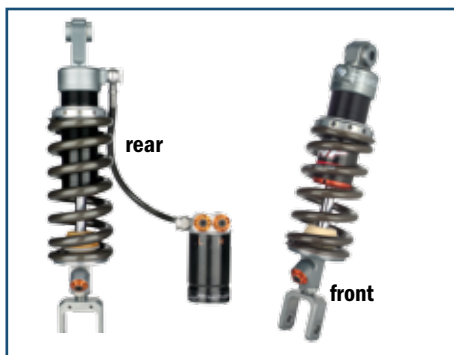

ArtNo.	Description	Price
17.06.8A. 76/78	Fusion suspension with reservoir fixed by a steel flex rear	€ 849,00
17.06.9A. 76/78	Emulsion suspension rear	€ 549,00
/02	Hydraulic preload adjustment	€ 229,00
17.06.9A. 77/79	Emulsion suspension front	€ 549,00



K1200S

built since 2005

1157 ccm cylinder capacity

power: 167 PS

max. torque 130 Nm

Brake Pedal Enlargement

It is nicely machined of aluminium and natural anodized.

The surface is slotted in order to avoid slipping. This enlargement simply slips on and is held in place with two set-screws.

ArtNo.	Description	Price
0102	Brake Pedal Enlargement	€ 30,50



Axle pivot Cover

This cover for the axle pivot for all new R1200, K1200 and K1300 bikes gives a nice looking finish to the rear end and gives your motorcycle a classy look.

ArtNo.	Description	Price
0072	polished	€ 21,90
0172	anodized	€ 21,90
0272	black anodized	€ 21,90



Bar-end weights

These bar-end weights made of Stainless steel or aluminium show that BMW riders are aware of function and form.

Article number: 0805 stainless steel 220 gram each

Article number: 0806 aluminium 84 gram each

Shipment: 2 end weights, 2 screws.

ArtNo.	Description	Price
0805	1 Set Stainless steel	€ 32,90
0806	1 Set Aluminium anodized	€ 25,90



Superbike handlebars

These handlebars create a new sporty looking and improve the handling of your bike. The mounting kit is made of high quality aluminium and the bars are especially designed for the BMW K1200S. Width of the handlebar is 770mm.

ArtNo.	Description	Price
AC-K1200S	Superbike handlebars	€ 469,00





GPS Mounting

Plug for BMW handlebars with inside diameter of 16mm.

Just insert the CNC machined plug in the open part of the handlebar (usually closed with a plastic plug).

The plug will stay in place thanks to the expansion fastener.

The external diameter of the part where you mount your GPS is 22,5mm to fit almost any navigation system.

Colour: Chrome or Black

Ram-ball is also possible. Art-no.: NH 3/1

ArtNo.	Description	Price
NH 3 ch	Chrome Plug	€ 39,95
NH 3 sw	Black Plug	€ 39,95



GPS Mounting Ram Ball

Plug for BMW handlebars with inside diameter of 16mm.

Just insert the CNC machined plug in the open part of the handlebar (usually closed with a plastic plug).

The plug will stay in place thanks to an expansion fastener.

Almost any navigation system can be fixed on the Ram ball of this GPS Mounting.

Colour: Black

ArtNo.	Description	Price
NH 3/1	Black Plug	€ 34,95

You can find the latest products and
bargains online: www.mhornig.com



Shift lever extension

Many BMW riders think that their shift lever is a little too thin and doesn't give enough grip when they're shifting.

This enlarger will solve this problem for you as it offers more grip and a more sporty look for your bike. Available in polished or anodized.

ArtNo.	Description	Price
0190	polished	€ 21,40
0390	anodized	€ 21,80
0195	polished with o-rings	€ 23,50
0395	anodized with o-rings	€ 23,90
19x3	O-ring	€ 0,65



Rear wheel centre cover

Rear wheel centre lug cover with emblem.

The holes in the covers serve for cooling! The lower temperature is based on the special angles of the drillings, which cause a little bit more concentrated air flow, but don't be worried it doesn't affect the drivability of your BMW.

ArtNo.	Description	Price
0116	polished	€ 61,90
0216	anodized	€ 62,90
0316	black anodized	€ 63,40





Speedometer trim

The polished rings for the speedometer and the rev counter are an optical improvement for your K1200S. Simply stick them to the speedometer and they can be removed without any residue.

ArtNo.	Description	Price
0406	1 Set polished	€ 49,95
0406-1	1 Set anodized	€ 51,40
s2ml	Silicone 2ml	€ 0,40



Frame Cover

Cover for the hole above the swing arm journal. Available in polished, anodized and black anodized version.

ArtNo.	Description	Price
0352	polished	€ 12,20
0453	anodized	€ 12,60
0454	black anodized	€ 12,95



Main Stand

With EG/ABE. This main stand is characterised by its accuracy of fit and stability. It is very simple to fit on your bike - just like changing the brake pads and so on... When you use an engine spoiler e.g. for the K1200S slight modifications are required. Instructions are included.

For BMW K1200S 2005 model or newer.

ArtNo.	Description	Price
HPS.07.360.100	Main Stand	€ 134,95



Sidestand foot enlargement

Feel safer parking your bike on dirt or asphalt with a side stand foot enlargement.

More than 100% larger contact area.

Made of high quality aluminium.

Black anodized.

Easy to install.

ArtNo.	Description	Price
0707	Sidestand foot enlargement	€ 23,90

Synto brake- and clutch lever

Synto is the name of the 6x adjustable CNC high-precision brake and clutch made of aluminium.

Combines elegance and functionality. Handling pure!

* 6 x adjustable CNC high-precision levers

* Racing proven Extremely light weight / 60g per lever

* CNC milled from high tech aeronautical norm

aluminium EN 2017

* Perfect design – convincing finish

* Brilliant control feeling * Aerodynamic louver

* Levers ca. 2 cm shorter than original

* Predetermined breaking point at long version

* Adjuster colour is always black, only the black lever has

a silver adjuster * For brake and clutch

* Including street homologation TÜV part certificate (ABE)



There is a video for this product online: www.mhornig.com

ArtNo.	Description	Price
BH27-BKH1-15-11-L	black-silver	€ 218,00
BH27-BKH1-17-15-L	red-black	€ 218,00
BH27-BKH1-14-15-L	blue-black	€ 218,00

Front lifter

Our front lifter is perfect for care, overwinter and servicing.

Made of steel 35x35mm, zinc-plated and quality „Made in Germany“.

ArtNo.	Description	Price
2039-80II	Front lifter	€ 98,90



Back lifter

Slide the rubber coated pipe of the Back lifter in the final drive of your BMW and lift it up. Easy to use by one person and very stable support for the bike.

Made of high quality steel. Diameter 42mm, zinc-plated.

The diameter of the rubber is 52,5mm.

ArtNo.	Description	Price
BT.heck-lifter	Back lifter	€ 89,90



Adjustable Foot pegs

The Vario Footrest System (Joint) will be mounted to the motorcycle like the original footpeg.

The adjustable Footrest system consists of 3 parts: Vario Joint, Vario Plate and the Footrest.

All Items sold as a set for left and right.



Part 1

The Vario Footrest System (Joint) will be mounted to the motorcycle like the original footpeg. The Joint is silver anodized.



Part 2

The Vario Plate is the part between the Footpeg and the Vario Footrest System (Joint). The Vario Plate is available in 3 length. We recommend 50mm only for the pillion rider.



ArtNo.	Description	Price
051 02 03 00	Driver Vario Footrest System	€ 41,90
051 02 03 10	Pillion rider Vario Footrest System	€ 41,90
051 00 00 23	23mm Vario Plate	€ 44,50
051 00 00 30	30mm Vario Plate	€ 44,90
051 00 00 50	50mm Vario Plate (only pillion rider)	€ 45,90
050 00 04 00 8	Super Grip Footrest black	€ 51,80
050 00 04 00 1	Super Grip Footrest silver	€ 51,70
050 00 01 00 8	Racing Footrest black	€ 29,90
050 00 01 00 1	Racing Footrest silver	€ 29,95

Part 3

The Footpeg will be mounted to the Vario Plate. The Super Grip Footpegs are available in silver with black rubber.

The Racing Footpegs are available in black or silver.

All Items sold as a set for left and right.



Cover

Covers for the fluid reservoirs.
You simply stick them onto the fluid reservoirs. Can be removed them without residue.
Made of high quality aluminium.
They are sold in a set of two.

ArtNo.	Description	Price
0700	1 Set polished	€ 39,80
0701	1 Set anodized	€ 39,90
0702	1 Set black anodized	€ 39,95
s2ml	Silicone 2ml	€ 0,40



Foot brake fluid reservoir cover

Cover for the foot brake fluid reservoir CNC machined of aluminium.
Image shows K1200R.
But it is also visible on: K1200S.

ArtNo.	Description	Price
0706	polished	€ 19,90
0706-1	anodized	€ 20,90
s2ml	Silicone 2ml	€ 0,40



Mirror Extensions

Our Mirror Extensions per 25mm are the perfect solutions if you see mainly your shoulders in the mirrors.
The mirrors will be moved a few centimetres out in order to improve the view to the rear.

ArtNo.	Description	Price
BK 05	Mirror Extensions (1 Set)	€ 49,95





Indicator bulb

Either orange or special coated. The special coated one only lights orange when you use the indicator Single.

ArtNo.	Description	Price
BLWB-CBUS	orange bulb 12V/10W	€ 2,55
BLWBT-CBUS	special bulb 12V/10W	€ 5,99
10031086	orange coated bulb 12V/16W front	€ 4,15
WLG-194	Chrome colour bulbs 12V/16W front	€ 7,90



Clear lenses

Clear or grey lenses for the front indicator indicators with 2 orange bulbs. For K1200S.
Replacement bulb with orange coating 12V/16W.
NEW! With European approval mark.

ArtNo.	Description	Price
400.10.20w	1 Set clear lenses	€ 69,90
400.10.20g	1 Set grey lenses	€ 69,90



Clear tail light

The clear tail light is available with a red bulb or LED and a grey tail light is available with LED.
Both LEDs have an E-mark and are very easy to install and fit perfectly.

ArtNo.	Description	Price
WLL-87-L	Clear lens with LED (not for model 08-)	€ 89,95
WLL-87-L-g	Grey lens with LED (not for model 08-)	€ 89,95



LED turning signals

Awesome brightness, fitted in seconds and including electronics on the back of the panel to ensure the correct flash rate. It is the complete turning signal and has a homologation. So it is the first road legal LED for BMW bikes! The LEDs flash yellow.
Sold in pairs (for left and right).

ArtNo.	Description	Price
01006	1 pair of LED turning signals with clear lenses	€ 89,95
01006-g	1 pair of LED turning signals with grey lenses	€ 89,95



Clear indicator lens

Clear indicator lenses. Sold in a set (2 pieces).
And if you want, also single.
With E-Mark, so they are homologated for the EU.
Shipping: 2 lenses incl. orange bulbs.

ArtNo.	Description	Price
CTS-0037	Clear indicator lens	€ 20,90
CTS-0037-g	Grey indicator lens	€ 20,95





Dash pad

Carbon look - protects this very visible part of your bike from your keys and enhances its appearance with this scratch resistant, self adhesive pad.

ArtNo.	Description	Price
80068	Dash pad	€ 14,50



Carbon Engine Spoiler

Made of high quality carbon fibre. The lower part is closed as used for racing. Fits the BMW K1200S.

ArtNo.	Description	Price
VEU.003.K120S.K	Engine Spoiler Long version	€ 699,90
VEU.012.K120S.K	Engine Spoiler Short version	€ 699,90



Carbon Rear Light Cover

This rear light cover is made of high quality carbon fibre and available in two versions: with or without holes for handgrips.

ArtNo.	Description	Price
RHO.008.K120S.K	Rear Light Cover with holes	€ 339,90



Carbon Side Covers

Give your bike a real racing optic with these covers near the instruments. For left and right sides.
One set consists of both parts.
For K1200S.

ArtNo.	Description	Price
VE0.013.K120S.K	Side Covers	€ 169,00



Carbon Front mudguard

This front mudguard is an optical improvement for your BMW K1200S.
Made of carbon fibre.

ArtNo.	Description	Price
KVO.002.K120S.K	Front mudguard	€ 229,90



Carbon Rear Hugger

Provides ultimate protection for the rear shock absorber.
Spend less time cleaning, more time riding!

Fits K1200S with tire sizes 180/55er and 190/50er.

ArtNo.	Description	Price
KHO.001.K120S.K	Rear Hugger	€ 269,90

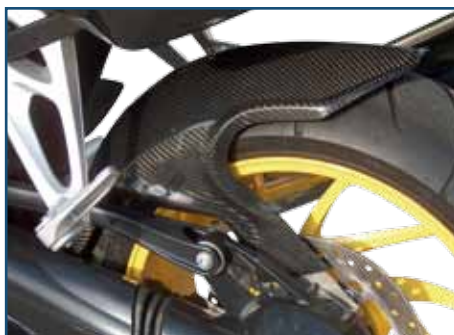

Carbon Reservoir-Cover Kit

Cover Kit for reservoirs of brake and clutch fluid reservoirs with carbon surface. The carbon fibre parts are precisely shaped and are to be fitted by glue.

ArtNo.	Description	Price
400.10.40	1 Set Reservoir-Covers	€ 59,00
s2ml	Silicone 2ml	€ 0,40





Carbon Fairing Kit

Fairing Kit made of extremely light and robust carbon fibre. Always sold as a set for the left and the right. For your BMW K1200S.

ArtNo.	Description	Price
VEL.014+ 015K120S.K	Fairing Kit	€ 999,80



Carbon Fuel Tank Fairing

This Fuel Tank Fairing is made of high quality carbon fibre and protects your tank from scratches. The items are specially made for your BMW K1200S.

The Fuel Tank Fairing Kit consisting of two parts.

ArtNo.	Description	Price
TAO.010.K120S.K	Battery cover & fuel tank middle part (2 parts)	€ 339,90
BAH.009.K120S.K	Battery Cover	€ 139,90



Carbon Headlight Fairing

With this part your K1200S will get a new and even more sporty appearance.

The headlight cover is produced of carbon fibre which is a very light and at the same time almost unbreakable.

ArtNo.	Description	Price
VE0.007.K120S.K	Headlight Fairing	€ 499,90



Carbon Heel guards

Heel guards made of carbon fibre.
A small and highly visible enhancement.
Very easy to install.
Sold in a set for the left and right.

ArtNo.	Description	Price
FS0.004.K120S.K	1 Set Heel guards	€ 149,90



Carbon Exhaust cover front

Beautiful high quality carbon fibre. Covers the joint between collector and silencer.
Only for the original exhaust.
Available for K1200S.

ArtNo.	Description	Price
ABV.006.K120S.K	Exhaust cover front	€ 149,90

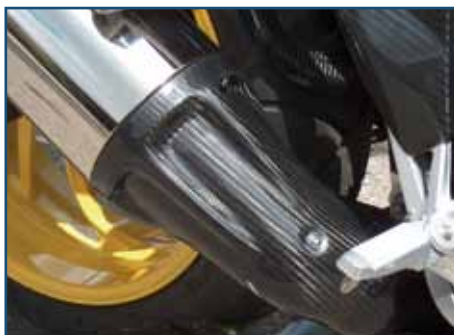

Carbon Clutch Cover

Small, but very strong clutch protector.
Made of carbon fibre.

ArtNo.	Description	Price
KD0.016.K120S.K	Clutch Cover	€ 89,90



Fork-Crash-Pads

These crash-pads for forks are made of cnc lathed plastic (Nylon). The mounting is made of cnc milled and anodized aluminium.
These crash pads provide additional protection for your fork.
Shipment includes the crash pads (left and right) and the mounting.

ArtNo.	Description	Price
FP100	Fork-Crash-Pads	€ 49,00





Touring screen

The touring shield has the same shape as the original, but with an additional raised wind deflector about 5-7 cm high at the top, covering the entire width. This deflects the wind over the rider and allows a relaxed ride, particularly on longer trips.

Length: 415mm

ArtNo.	Description	Price
T-k1200s-rg	Smoke grey	€ 79,90
T-k1200s-k	Clear	€ 79,90
T-k1200s-sw	Black	€ 79,90



Vario touring screen

This type of touring screen has a small spoiler at the top of the wind deflector. Can be manually set to seven positions in terms of angle and height. Tiresome turbulence is also reduced by the air flow at the rear of the spoiler.

Length: 435mm

ArtNo.	Description	Price
VT-k1200s-rg	Smoke grey	€ 119,90
VT-k1200s-k	Clear	€ 119,90



Original shape screen

This wind screen has the same shape like the original windscreen but is available in different colours.

Length 350mm, with ABE.

Available in clear, smoke grey and black.

ArtNo.	Description	Price
O-K1200S-rg	Smoke grey	€ 69,90
O-K1200S-k	Clear	€ 69,90
O-K1200S-s	Black	€ 69,90

Spoiler screen

This screen also comes up with the original screen but with a small lip edge at the top.

The spoiler screen will be delivered with ABE, length: 370mm

ArtNo.	Description	Price
S-k1200s-rg	Smoke grey	€ 79,90
S-k1200s-k	Clear	€ 79,90
S-k1200s-sw	Black	€ 79,90



Racing screen

The racing screen has basically the same shape as the original one, with a little hump in the middle, to reduce the wind pressure on the helmet.

With ABE, length: 405mm.

ArtNo.	Description	Price
R-k1200s-rg	Smoke grey	€ 79,90
R-k1200s-k	Clear	€ 79,90





Sebring Twister

K1200S from 05 Typ K12, 123kW

Slip-on incl. front exhaust silencer, Twister, with EG/ABE. Choose the cover you like most! The exhaust is very easy to install and much lighter than the original one. But the most important argument is the deep and throaty sound combined with more power and more torque throughout the whole speed range. Real driving pleasure and of course with ABE (European Homologation)!

ArtNo.	Description	Price
TAT4051015K	slip on, EG/ABE incl. Cat., Aluminium	€ 556,00
TTT4051015K	slip on, EG/ABE incl. Cat., Titanium	€ 674,00



Remus HexaCone

More than 4kg lighter compared to the original exhaust. Not only nice for the eyes but also powerful sound - the HexaCone.

Available with three covers: High-grade Steel, Carbon Fibre or Titanium

ArtNo.	Description	Price
154682 088305	High-grade Steel incl. Cat.	€ 657,00
154882 088305	Titanium incl. Cat.	€ 719,00

You need a Tank bag, Tear Seat Bag, Duffel Bag,
Inside Bag, Universal Bag or Tool Bag?

You can find it under SOFT BAGS in the catalog
and online: www.mhornig.com



WP suspension front & rear

Our WP suspensions will be specially adjusted for you! Because of this please inform us about your weight with clothes and helmet, the weight of your luggage (perhaps pillion rider), where you ride (street, off-road, race) and how you ride (sport, touring, and so on) in the „comment“ of your order.

The Fusion as well as the Emulsion suspension can be combined with the hydraulic preload adjustment. (productnr. /02)

You can choose any spring colour you like.

Suspension rear: adjustable rebound preload adjuster

High/Low speed compression separately adjustable, each 16 times (256 possibilities) (only Spin and Fusion)

Suspension front: preload adjuster, 16 positions.

For riders wanting the upmost from their machine Exceptional cooling properties due to the use of heat diverting aluminium alloys, therefore constant shock absorption and longer life

Lightweight through use of high quality materials
Adjustable length is standard
Recognised safety certificate

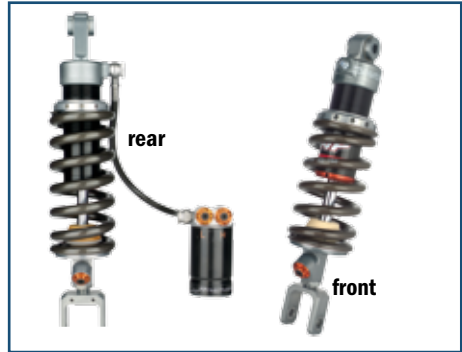

ArtNo.	Description	Price
17.06.9A. 76/78	Emulsion suspension rear	€ 549,00
17.06.8A. 76/78	Fusion suspension with reservoir fixed by a steel flex rear	€ 849,00
/02	Hydraulic preload adjustment	€ 229,00
17.06.9A. 77/79	Emulsion suspension front	€ 549,00

You must send your seat to us!

How do you sit on your motorcycle seat?
Do you want to change something?

Then read through the pages of the catalog
SEAT ALTERATION.

We will change your seat exactly like you want it to be.





K1200GT

built since 2006

1157 ccm cylinder capacity

power: 152 PS

max. torque 130 Nm

GPS Mounting

Easy and fast mounting is possible with our new GPS Mounting for BMW K1200GT.

The windscreen can still be changed in its position and you always mean your GPS without looking away from the street.

No vibrations! For Garmin SPIII, SP26**, 2720, Zumo 550, Zumo 660 and Nüvi series. SP26** & 2720 owners will need to purchase the Garmin Motorcycle Mount.

Colour: Anodized Silver

In order to provide the necessary distance from the screen you need the Zumo adaptor for all Garmin and BMW Navigators (article: Zumo-Ad).



ArtNo.	Description	Price
44007	GPS Mounting	€ 79,90
Zumo-Ad	Adapter for Garmin Zumo This adapter is made for all Garmin SPIII, SP26**, 2720 & Zumo. With this adapter the GPS is 12mm closer to you and it can be dislocated 7,5mm or 15mm higher or lower as usual. You need this option for the Zumo's bus bar. Made of black Pom incl. all screws.	€ 9,95
tomtom-Ad	Adapter for TomTom Rider Incl. screws for mounting in the GPS mount and the TomTom holder.	€ 9,55
tomt-Ad Ed 2	Adapter for TomTom 2nd Edition Incl. screws for mounting in the GPS mount and the TomTom holder.	€ 14,90
ram-1zoll	Adapter for 1" Ram-Ball	€ 29,90

You can find the latest products and bargains
online: www.mhornig.com



Frame cover

This cover for the open hole beyond the swing arm pivot is made of aluminium and available in different versions. It gets fixed on the left side.

ArtNo.	Description	Price
0340	polished	€ 12,45
0440	anodized	€ 12,80
0441	black anodized	€ 12,80



Brake Pedal Enlargement

It is nicely machined of aluminium and natural anodized. The surface is slotted in order to avoid slipping. This enlargement simply slips on and is held in place with two set-screws.

ArtNo.	Description	Price
0102	Brake Pedal Enlargement	€ 30,50



Axle pivot Cover

This cover for the axle pivot for all new R1200, K1200 and K1300 bikes gives a nice looking finish to the rear end and gives your motorcycle a classy look.

ArtNo.	Description	Price
0072	polished	€ 21,90
0172	anodized	€ 21,90
0272	black anodized	€ 21,90



Centre cap with Emblem

Made of aluminium with emblem. Changeover instructions are included in delivery.

ArtNo.	Description	Price
0084	polished	€ 22,50
0284	anodized	€ 22,90

Rear wheel centre cover

Rear wheel centre lug cover with emblem.

The holes in the covers serve for cooling!
The lower temperature is based on the special angles of the drillings, which cause a little bit more concentrated air flow, but don't be worried it doesn't affect the drivability of your BMW.

ArtNo.	Description	Price
0116	polished	€ 61,90
0216	anodized	€ 62,90
0316	black anodized	€ 63,40



Stainless steel end weight

These end weights are made of Stainless steel and create a noble look for your bike. Included are two S/S-end weights and two S/S-countersunk screws M8 for fixing. BMW K1200GT 2006 model or newer

ArtNo.	Description	Price
0451	1 Set Stainless steel end weight	€ 30,95



Oil cooler screens

This anodized aluminium screen protect the oil cooler from stones, flies and other dross. It is very easy to install and gives your K1200GT an even more sporty appearance.

If you have no silicone you can also order our high-quality silicone which is pre-filled in the volume you need and easy to dose.

ArtNo.	Description	Price
0607	Oil cooler screens	€ 19,90
s10ml	Silicone 10ml	€ 0,80





Shift lever extension

Many BMW riders think that their shift lever is a little too thin and doesn't give enough grip when they're shifting. This enlarger will solve this problem for you as it offers more grip and a more sporty look for your bike. Available in polished or anodized.

ArtNo.	Description	Price
0190	polished	€ 21,40
0390	anodized	€ 21,80
0195	polished with o-rings	€ 23,50
0395	anodized with o-rings	€ 23,90
19x3	O-Ring	€ 0,65



Synto brake- and clutch lever

Synto is the name of the 6x adjustable CNC high-precision brake and clutch made of aluminium. Combines elegance and functionality. Handling pure!

- * 6 x adjustable CNC high-precision levers
 - * Racing proven Extremely light weight / 60g per lever
 - * CNC milled from high tech aeronautical norm aluminium EN 2017
 - * Perfect design – convincing finish
 - * Brilliant control feeling * Aerodynamic louver
 - * Levers ca. 2 cm shorter than original
 - * Predetermined breaking point at long version
 - * Adjuster colour is always black, only the black lever has a silver adjuster * For brake and clutch
 - * Including street homologation TÜV part certificate (ABE)
- There is a video for this product online: www.mhornig.com



ArtNo.	Description	Price
BKH3-KH35-15-11-L	black-silver	€ 218,00
BKH3-KH35-17-15-L	red-black	€ 218,00
BKH3-KH35-14-15-L	blue-black	€ 218,00

Sidestand foot enlargement

Feel safer parking your bike on dirt or asphalt with a sidestand foot enlargement.

More than 100% bigger contact area.

Made of high quality aluminium.

Black anodized.

Easy to install.



The pictures show the higher version article 0718 and article 0718-20. This one is about 20mm high (10mm can easily be screwed on or off) and makes your bike stand more upright, much less effort to get ready for riding. Especially when you ride with luggage.

ArtNo.	Description	Price
0718	Sidestand foot enlargement normal version	€ 25,90
0718-20	Heightening	€ 6,80





Front lifter

Our front lifter fits for BMW K1200GT. It is perfect for care, overwinter and servicing. Made of steel 35x35mm, zinc-plated and quality „Made in Germany“.

ArtNo.	Description	Price
2039-80II	Front lifter	€ 98,90



Back lifter

Slide the rubber coated pipe of the Back lifter in the final drive of your BMW and lift it up. Easy to use by one person and very stable support for the bike. Made of high quality steel. Diameter 42mm, zinc-plated. The diameter of the rubber is 52,5mm.

ArtNo.	Description	Price
BT.heck-lifter	Back lifter	€ 89,90



V-Stream Windshield

The „V-Stream“ Windshield set new standards for design, technology and comfort.

Made of Quantum/Lexan Polycarbonate which is 10x more scratch-resistant than usual Acrylic.

The windscreen will be shipped with everything you need to mount it.

Windshield V-Stream, clear, with homologation,

ArtNo.	Description	Price
115107	Height 64cm, Width 60cm	€ 219,00
Z2453	Height 68cm, Width 60,5cm	€ 259,00



K Sticker

This 6-piece K Sticker is especially designed for your BMW K1200GT (model 2006 - *) in order to give your luxury tourer a distinctive and individual look. Made of high quality foil which can be easily applied. For left and right.

ArtNo.	Description	Price
k-anthrazit	1 Set anthracite K Sticker	€ 79,90
k-silver	1 Set silver K Sticker	€ 79,90
00WZ02	Ductor with felt	€ 2,95

Clear indicator Lenses

Not only street legal with E-mark but also looks very nice and sporty.
Incl. orange Bulbs.
Fit for K1200GT 2006-*.
Street legal with E-mark!

ArtNo.	Description	Price
WLB-59	1 Set Clear indicator Lenses	€ 69,90
WLB-59g	1 Set Grey indicator Lenses	€ 69,90
WLG-05	1 Piece orange bulb	€ 4,95





Dash pad

Carbon look - protects this very visible part of your bike from your keys and enhances its appearance with this scratch resistant, self adhesive pad.

ArtNo.	Description	Price
80064	Dash pad	€ 10,45



Carbon Clutch Cover

Small, but very strong clutch protector. Made of carbon fibre.

ArtNo.	Description	Price
KDO.016.K120S.K	Clutch Cover	€ 89,90



Fork-Crash-Pads

These crash-pads for forks are made of cnc lathed plastic (Nylon). The mounting is made of cnc milled and anodized aluminium.

These crash pads provide additional protection for your fork.

Shipment includes the crash pads (left and right) and the mounting.

ArtNo.	Description	Price
FP100	Fork-Crash-Pads	€ 49,00



How do you sit on your motorcycle seat?
Do you want to change something?

Then read through the pages of the catalog

SEAT ALTERATION.

We will change your seat exactly like you want it to be.

Remus HexaCone

More than 4kg lighter compared to the original exhaust.
Not only nice for the eyes but also powerful sound -
the HexaCone.

Available with three covers:
High-grade Steel, Carbon Fibre or Titanium

ArtNo.	Description	Price
154682 088305	High-grade Steel incl. Cat.	€ 657,00
154882 088305	Titanium incl. Cat.	€ 719,00



Sebring Twister

K1200GT ab 06 Typ K12, 123kW

Slip-on incl. front exhaust silencer, Twister, with EG/ABE.
Choose the cover you like most! The exhaust is very easy
to install and much lighter than the original one. But the
most important argument is the deep and throaty sound
combined with more power and more torque throughout
the whole speed range. Real driving pleasure and of
course with ABE (European Homologation)!

ArtNo.	Description	Price
TAT4051015K	slip on, EB/ABE incl. Cat., Aluminium	€ 556,00
TTT4051015K	slip on, EG/ABE incl. Cat., Titanium	€ 674,00



You need a Tank bag, Tear Seat Bag, Duffel Bag, Inside Bag, Universal Bag
or Tool Bag? You can find it under **SOFT BAGS** in the catalog and online:
www.mhornig.com



K 1200 LT



K1200LT

built since 1998

1171 ccm cylinder capacity

power: 116 PS

max. torque 119 Nm



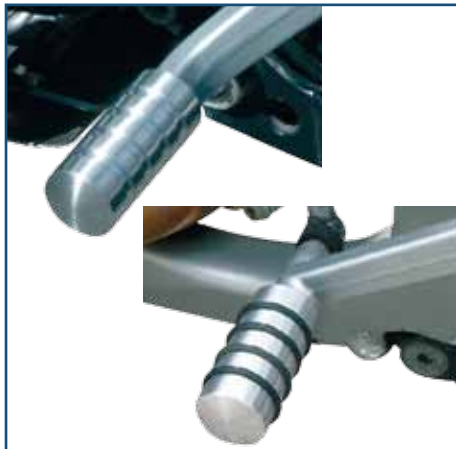

Shift lever extension

Many BMW riders think that their shift lever is a little too thin and doesn't give enough grip when they're shifting. This enlarger will solve this problem for you as it offers more grip and a more sporty look for your bike. Available in polished or anodized.

ArtNo.	Description	Price
0190	polished	€ 21,40
0390	anodized	€ 21,80
0195	polished with o-rings	€ 23,50
0395	anodized with o-rings	€ 23,90
19x3	O-Ring	€ 0,65



Key holder with emblem

Useful key holder made of knurled aluminium, polished on top, with our emblem. Just slot in the „Emergency key“ and fix with a setscrew. 0076 : Also possible to hook in a carabineer.

ArtNo.	Description	Price
0075	polished without eye	€ 19,70
0076	polished with eye	€ 28,50



Paralever pivot cap

Effective prevention of dirt is guaranteed by this paralever pivot cap. Highest quality and a perfect look anodized aluminium.

ArtNo.	Description	Price
0070	anodized	€ 12,90



Frame cover

Nice covers for the frame of all BMW K1200LT. Delivered as a set. Available in polished and anodized.

ArtNo.	Description	Price
0350	1 Set polished	€ 19,95
0450	1 Set anodized	€ 21,95

Oil filler plug with emblem

This oil filler plug is made of aluminium and available in polished or anodized. Use an Allen tool size 3 (which should usually belong to your BMW tools) in order to close and open the oil filler plug.

ArtNo.	Description	Price
0470	polished	€ 25,00
0475	anodized	€ 25,00
10013	O-ring	€ 1,60



Oil filler plug

Oil filler plug with Allen tool. Very nice looking and brilliant protection. Use an Allen tool size 6 (usually found in your BMW tools) in order to close and open the oil filler plug.

ArtNo.	Description	Price
0460	polished	€ 19,80
0465	anodized	€ 19,90
10013	O-ring	€ 1,60



Rear wheel centre cover

A cover made of aluminium - with emblem. Just put it into the hole over the screw in the wheel.

An o-ring keeps this part firmly in place.

Note: The Rear wheel centre cover does not fit when the bolt in the middle protrudes further than the wheel.

ArtNo.	Description	Price
0204	polished	€ 20,90
0204-1	anodized	€ 21,50



Hardware kit

Hardware kit consisting of 68 S/S screws. The original black screws on your motorcycle fairing lose a little bit of crispness each time they are screwed in or out.

These stainless and polished screws look great and remain that way for years.

Complete set with all screws needed and fitting guidelines.

ArtNo.	Description	Price
70035	Hardware kit	€ 33,90





S/S screws

Brake fluid - & clutch reservoir

get a new look with these 4x S/S screws

70070: For all (elderly) Bikes with a hydraulic brake and no hydraulic clutch

70075: For all (newer) Bikes with a hydraulic brake and a hydraulic clutch

ArtNo.	Description	Price
70070	4 x M5x16	€ 3,95
70075	4 x M4x16	€ 3,95



Chrome cap I

The chrome caps for the gear oil filler screw are an optical improvement for your BMW.

You simply push them on. The caps fit into the gear oil filler screw with Allen head and will fit any other screws with the same Allen size.

ArtNo.	Description	Price
0500	Big chrome caps	€ 4,25
0501	Small chrome caps	€ 3,75



Chrome cap II

Chrome cap II was created for covering the gear oil filler screw.

Like cap I it is just pushed on and fits perfectly.

ArtNo.	Description	Price
0502	Chrome cap II	€ 3,80



Chrome cap III

The chrome cap III for the light adjustment will give your BMW another additional highlight.

The installation is as easy as effective - just stick it on with some glue like Uhu or silicone.

If you have no silicone at home you can also order our high quality silicone which is pre-filled in the volume you need and easy to dose.

ArtNo.	Description	Price
0505	Chrome cap III	€ 4,40
s2ml	Silicone 2ml	€ 0,40

GPS Mounting

Bolt + Ram-Ball

CNC machined for TomTom Rider 2 and Garmin Zumo.

You can mount all Ram-Mounts on the Ram-Ball.

RAM mount secured so that the NAVI longer comes to the centre of the handlebars. Otherwise, the mirror is covered. See: Art-No.: NH 3 / 1; Colour: Black



ArtNo.	Description	Price
NH 1/5	GPS Mounting black	€ 24,95

Clear indicator lenses front

Amber bulbs included, sold in pairs!

Fits K1200LT 99-07.



ArtNo.	Description	Price
WLB-46	1 Set clear indicator lenses	€ 42,95
WLB-46-S	1 Set black indicator lenses	€ 42,95

Indicator bulb

Either orange or special coating. The special coated one only lights orange when you use the indicator (usually used with transparent lenses).

Single

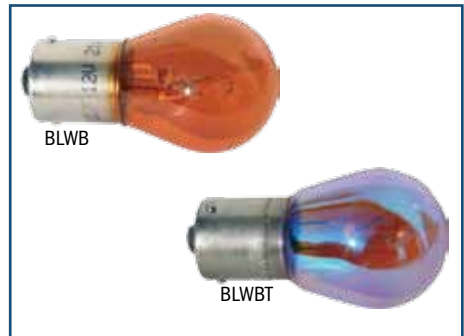

ArtNo.	Description	Price
BLWB	orange bulb 12V/21W	€ 2,45
BLWBT	Special coated bulb 12V/21W	€ 9,90





V-Stream Windshield

The „V-Stream“ Windshield set new standards for design, technology and comfort.

Made of Quantum/Lexan Polycarbonate which is 10x more scratch-resistant than usual Acrylic.

The windscreen will be shipped with everything you need to mount it.

Windshield V-Stream, clear, with homologation,

ArtNo.	Description	Price
115106	Height 62cm, Width 68cm	€ 229,00
Z2461	Height 62,8cm, Width 73,6cm	€ 279,00
Z2462	Height 53,6cm, Width 68,6cm	€ 249,00



WP suspension rear

Our WP suspensions will be specially adjusted for you! Because of this please inform us about your weight with clothes and helmet, the weight of your luggage (perhaps pillion rider), where you ride (street, off-road, race) and how you ride (sport, touring, and so on) in the „comment“ of your order.

The Emulsion suspension can be combined with the hydraulic preload adjustment. (productnr. /02)

For extra charge you can choose any spring colour you like.

adjustable rebound
preload adjuster

For riders wanting the upmost from their machine
Exceptional cooling properties due to the use of heat diverting aluminium alloys, therefore constant shock absorption and longer life
Lightweight through use of high quality materials
Adjustable length is standard
Recognised safety certificate

ArtNo.	Description	Price
17.06.U9.16/ Y9.74	Emulsion suspension rear	€ 549,00
/02	Hydraulic preload adjustment	€ 229,00

More accessories for all bikes
online: www.mhornig.com

You must send
your seat
to us!



How do you sit on your motorcycle seat? Do you want to change something in your seat?

Then read through the pages of the catalog **SEAT ALTERATION**.
We will change your seat exactly like you want it to be.

You need a Tank bag, Tear Seat Bag, Duffel Bag,
Inside Bag, Universal Bag or Tool Bag?
You can find it under **SOFT BAGS** in the catalog
and online: www.mhornig.com





K1300R

built since 2009

1293 ccm cylinder capacity

power: 173 PS

max. torque 140 Nm at 8.250/min.

Adjustable Foot pegs

The Vario Footrest System (Joint) will be mounted to the motorcycle like the original footpeg.

The adjustable Footrest system consists of 3 parts: Vario Joint, Vario Plate and the Footrest.
All Items sold as a set for left and right.



Part 1

The Vario Footrest System (Joint) will be mounted to the motorcycle like the original footpeg. The Joint is silver anodized.



Part 2

The Vario Plate is the part between the Footpeg and the Vario Footrest System (Joint). The Vario Plate is available in 3 length. We recommend 50mm only for the pillion rider.



ArtNo.	Description	Price
051 02 03 00	Driver Vario Footrest System	€ 41,90
051 02 03 10	Pillion rider Vario Footrest System	€ 41,90
051 00 00 23	23mm Vario Plate	€ 44,50
051 00 00 30	30mm Vario Plate	€ 44,90
051 00 00 50	50mm Vario Plate (only pillion rider)	€ 45,90
050 00 04 00 8	Super Grip Footrest black	€ 51,80
050 00 04 00 1	Super Grip Footrest silver	€ 51,70
050 00 01 00 8	Racing Footrest black	€ 29,90
050 00 01 00 1	Racing Footrest silver	€ 29,95

Part 3

The Footpeg will be mounted to the Vario Plate. The Super Grip Footpegs are available in silver with black rubber.

The Racing Footpegs are available in black or silver.
All Items sold as a set for left and right.

Main Stand

With EG/ABE. This main stand is characterised by its accuracy of fit and stability. It is very simple to fit on your bike - just like changing the brake pads and so on...

When you use an engine spoiler e.g. for the K1300S slight modifications are required. Instructions are included.



ArtNo.	Description	Price
HPS.07.634.10000/B	Main Stand	€ 129,95



Mirror Extensions

Our Mirror Extensions are the perfect solutions if you see mainly your shoulders in the mirrors. The mirrors will be moved a few centimetres out in order to improve the view to the rear.

ArtNo.	Description	Price
BK 02	Mirror Extensions 1 Set (M10)	€ 49,95



Frame Cover

Cover for the hole above the swing arm journal. Available in polished, anodized and black anodized version.

ArtNo.	Description	Price
0352	polished	€ 12,20
0453	anodized	€ 12,60
0454	black anodized	€ 12,95



Cover

Covers for the fluid reservoirs. You simply stick them onto the fluid reservoirs. Can be removed them without residue. Made of high quality aluminium. They are sold in a set of two.

ArtNo.	Description	Price
0700	1 Set polished	€ 39,80
0701	1 Set anodized	€ 39,90
0702	1 Set black anodized	€ 39,95
s2ml	Silicone 2ml	€ 0,40



GPS Mounting

Plug for BMW handlebars with inside diameter of 12mm. Just insert the CNC machined plug in the open part of the handlebar (usually closed with a plastic plug). The plug will stay in place thanks to an expansion fastener. Almost any navigation system can be fixed on the Ram-ball of this GPS Mounting.

Colour: Black

ArtNo.	Description	Price
NH 3/1	Black Plug	€ 34,95

Speedometer cover

In order to customize your BMW K1300R's speedo. Made of milled or laser cutted aluminium, polished or anodized.

Very easy to mount with usual silicon.

An install instruction is included in the set for the speedo and the revolution counter.

ArtNo.	Description	Price
0411	1 Set polished	€ 74,90
0411-1	1 Set anodized	€ 74,95
s10ml	Silicone 10ml	€ 0,80



Protection

If your K1300R falls over or be involved in a crash these aluminium protection pads will avoid serious damage.

You install them in place of the original plastic pads.

Shipment: a set for the left and right.

ArtNo.	Description	Price
0800	1 Set polished	€ 49,00
0801	1 Set anodized	€ 49,90



Rear wheel centre cover

Rear wheel centre lug cover with emblem.

The holes in the covers serve for cooling!
The lower temperature is based on the special angles of the drillings, which cause a little bit more concentrated air flow, but don't be worried it doesn't affect the drivability of your BMW.

ArtNo.	Description	Price
0116	polished	€ 61,90
0216	anodized	€ 62,90
0316	black anodized	€ 63,40





Brake Pedal Enlargement

It is nicely machined of aluminium and natural anodized. The surface is slotted in order to avoid slipping. This enlargement simply slips on and is held in place with two set-screws.

ArtNo.	Description	Price
0102	Brake Pedal Enlargement	€ 30,50



Sidestand foot enlargement

Feel safer parking your bike on dirt or asphalt with a side stand foot enlargement.

More than 100% larger contact area.

Made of high quality aluminium.

Black anodized.

Easy to install.

ArtNo.	Description	Price
0707	Sidestand foot enlargement	€ 23,90



Bar-end weights

These bar-end weights made of Stainless steel or aluminium show that BMW riders are aware of function and form.

Article number: 0805 stainless steel 220 gram each

Article number: 0806 aluminium 84 gram each

Shipment: 2 end weights, 2 screws.

ArtNo.	Description	Price
0805	1 Set Stainless steel	€ 32,90
0806	1 Set Aluminium anodized	€ 25,90



Axle pivot Cover

This cover for the axle pivot for all new R1200, K1200 and K1300 bikes gives a nice looking finish to the rear end and gives your motorcycle a classy look.

ArtNo.	Description	Price
0072	polished	€ 21,90
0172	anodized	€ 21,90
0272	black anodized	€ 21,90

Crashbars

Our crashbars are made of high-quality steel and are special designed for your K1300R. The crashbars are designed to be very robust and allow for an equal distribution of forces in a crash. You and your bike are protected in the best possible way. Crashbars offer a very good protection but they can reduce the cornering angle.

ArtNo.	Description	Price
SBL.07.413.100/B	Crashbars black	€ 154,95
SBL.07.413.100/S	Crashbars silver	€ 149,95



Synto brake- and clutch lever

Synto is the name of the 6x adjustable CNC high-precision brake and clutch made of aluminium. Combines elegance and functionality. Handling pure!

- * 6 x adjustable CNC high-precision levers
 - * Racing proven Extremely light weight / 60g per lever
 - * CNC milled from high tech aeronautical norm aluminium EN 2017
 - * Perfect design - convincing finish
 - * Brilliant control feeling * Aerodynamic louver
 - * Levers ca. 2 cm shorter than original
 - * Predetermined breaking point at long version
 - * Adjuster colour is always black, only the black lever has a silver adjuster * For brake and clutch
 - * Including street homologation TÜV partcertificate (ABE)
- There is a video for this product online: www.mhornig.com

ArtNo.	Description	Price
BH27-BKH1-15-11-L	black-silver	€ 218,00
BH27-BKH1-17-15-L	red-black	€ 218,00
BH27-BKH1-14-15-L	blue-black	€ 218,00



Shift lever extension

Many BMW riders think that their shift lever is a little too thin and doesn't give enough grip when they're shifting. This enlarger will solve this problem for you as it offers more grip and a more sporty look for your bike. Available in polished or anodized.

ArtNo.	Description	Price
0190	polished	€ 21,40
0390	anodized	€ 21,80
0195	polished with o-rings	€ 23,50
0395	anodized with o-rings	€ 23,90
19x3	O-ring	€ 0,65

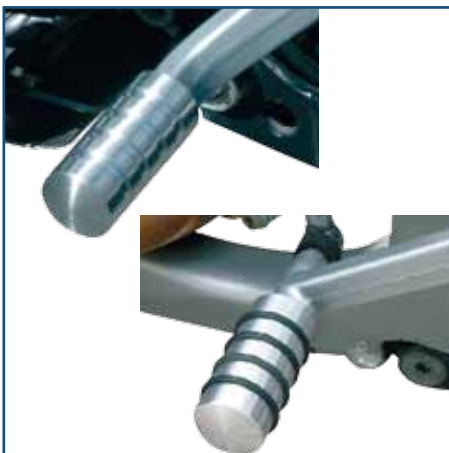



Fork-Crash-Pads

These crash-pads for forks are made of cnc lathed plastic (Nylon). The mounting is made of cnc milled and anodized aluminium.

These crash pads provide additional protection for your fork.

Shipment includes the crash pads (left and right) and the mounting.

ArtNo.	Description	Price
FP100	Fork-Crash-Pads	€ 49,00



Front lifter

Our front lifter fits BMW K1300R.

It is perfect for care, overwinter and servicing.

Made of steel 35x35mm, zinc-plated and quality

„Made in Germany“.

ArtNo.	Description	Price
2039-80II	Front lifter	€ 98,90



Back lifter

Slide the rubber coated pipe of the Back lifter in the final drive of your BMW and lift it up. Easy to use by one person and very stable support for the bike.

Made of high quality steel. Diameter 42mm, zinc-plated.

The diameter of the rubber is 52,5mm.

ArtNo.	Description	Price
BT.heck-lifter	Back lifter	€ 89,90



Vario touring screen

This touring screen has a spoiler at the top of the airfoil; the spoiler can be adjusted for height and angle in seven positions. The air current deflected behind the spoiler reduces the otherwise annoying turbulence.

ArtNo.	Description	Price
vt-k1200r-rg	Smoke grey	€ 135,90
vt-k1200r-k	Clear	€ 135,90

Crash-Pads Slider

Our Crash-Pads or Sliders protect your frame, engine and fairing of your motorcycle. This crash pad is designed to fit perfect to your motorcycle. It is made of high-strength milled aluminium and high-strength POM plastic. All our pads are screwed to your motorcycle at least at 2-3 points. The advantage over round crash pads is that these slider can't break or snag on something on the road.

Shipment: Crash Pads for the left and right side with mounting.



ArtNo.	Description	Price
RLBM03	Crash-Pads Slider	€ 279,00

Clear indicator lens

Clear indicator lenses. Sold in a set (2 pieces).

And if you want, also single.

With E-Mark, so they are homologated for the EU. Shipping: 2 lenses incl. orange bulbs.



ArtNo.	Description	Price
CTS-0037	Clear indicator lens	€ 20,90
CTS-0037-g	Grey indicator lens	€ 20,95

LED turning signals

Awesome brightness, fitted in seconds and including electronics on the back of the panel to ensure the correct flash rate. It is the complete turning signal and has a homologation. So it is the first road legal LED for BMW bikes! The LEDs flash yellow.

Sold in pairs (for left and right).



ArtNo.	Description	Price
01006	1 pair of LED turning signals with clear lenses	€ 89,95
01006-g	1 pair of LED turning signals with grey lenses	€ 89,95

Indicator bulb

Either orange or special coated. The special coated one only lights orange when you use the indicator (usually used with transparent lenses).

Single

ArtNo.	Description	Price
BLWB-CBUS	orange coated bulb 12V/10W	€ 2,55
BLWBT-CBUS	special coated bulb 12V/10W	€ 5,99

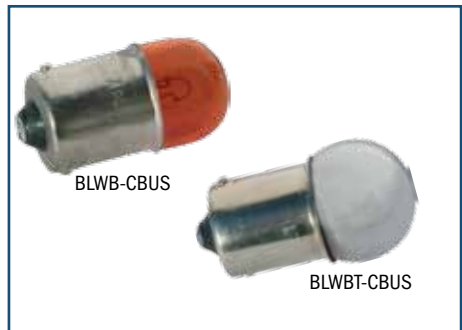



Dash pad

Carbon look - protects this very visible part of your bike from your keys and enhances it's appearance with this scratch resistant, self adhesive pad.

ArtNo.	Description	Price
80067	Dash pad	€ 14,55



Carbon Front mudguard PowerCup Version

Short and sporty fender for K1300R from the Powercup-series.

Also made of carbon fibre.

ArtNo.	Description	Price
KVO.050.K120R.K	Front mudguard PowerCup Version	€ 219,90



Carbon Battery Cover

Fuel tank cover carbon middle part for BMW K1300R.

ArtNo.	Description	Price
BAH.004.K120R.K	Battery Cover	€ 139,90



Carbon Reservoir-Cover Kit

Cover Kit for reservoirs of brake and clutch fluid reservoirs with carbon surface. The carbon fibre parts are precisely shaped and are to be fitted by glue.

ArtNo.	Description	Price
400.10.40	1 Set Reservoir-Covers	€ 59,00
s2ml	Silicone 2ml	€ 0,40



Carbon Exhaust Protector

High quality carbon fibre, best workmanship, sporty look.

Maximum weight saving and easy to install

Fits only the original exhaust!

ArtNo.	Description	Price
ABV.002.K130S.K	Exhaust Protector	€ 139,90

Carbon Rear Hugger

Provides ultimate protection for the rear shock absorber.
Spend less time cleaning, more time riding!

Fits BMW K1300R. (190/55er tires).

ArtNo.	Description	Price
KHO.101.K130S.K	Rear Hugger	€ 269,90



Carbon Clutch Cover

Small, but very strong clutch protector.
Made of carbon fibre.

ArtNo.	Description	Price
KDO.016.K120S.K	Clutch Cover	€ 89,90



Carbon Heel guards

Heel guards made of carbon fibre.
A small and highly visible enhancement.
Very easy to install.
Sold in a set for the left and right.

ArtNo.	Description	Price
FSO.004.K120S.K	1 Set Heel guards	€ 149,90



Carbon Engine Spoiler

Our Engine Spoiler is made of motor sport carbon fibre
and comes incl. fastener. Available for K1300R.
Can be used with the main stand and fits to the most
after sales exhaust systems.

ArtNo.	Description	Price
VEU.013.K120R.K	Engine Spoiler	€ 869,90



Carbon Rear Light Cover

This rear light cover is made of carbon fibre and available
in two versions: with or without holes for handgrips.

ArtNo.	Description	Price
RHO.007.K120R.K	Rear Light Cover (with holes)	€ 339,90
RHO.008.K120R.K	Rear Light Cover (without holes)	€ 339,90





Remus Hexacone

More than 2,5 kg lighter compared to the original exhaust. Not only nice for the eyes but also powerful sound - the HexaCone.
Available with two covers: Stainless steel or Titanium.

There is a video for this product online: www.mhornig.com

ArtNo.	Description	Price
094652 088509	Hexacone, slip on, Stainless Steel	€ 675,00
094852 088509	Hexacone, slip on, Titanium	€ 758,00



**How do you sit on your motorcycle seat?
Do you want to change something?**

Then read through the pages of the catalog
SEAT ALTERATION.

We will change your seat exactly like you want it to be.

**You need a Tank bag, Tear Seat Bag, Duffel Bag,
Inside Bag, Universal Bag or Tool Bag?
You can find it under SOFT BAGS in the catalog
and online: www.mhornig.com**



I INTERMOT



Motorcycle Accessory Hornig GmbH

we will also have a booth in 2012 at the Intermot in Cologne.

We will present our latest custom BMW Motorcycles like BMW S1000RR 2012, R1200GS, and much more.

Next to the bikes the visitors can touch, test and have a closer look at our individual products and which range of products we offer for BMW Motorcycles.





K1300GT

built since 2009

1293 ccm cylinder capacity

power: 160 PS

max. torque 135 Nm at 8.000/min.

GPS Mounting

Easy and fast mounting is possible with our new GPS Mounting for BMW K1300GT.

The windscreen can still be changed in its position and you always mean your GPS without looking away from the street.

K1300GT owners' have to turn the brake line a little bit. (Install instructions are included)

No vibrations!

For Garmin SPIII, SP26**, 2720, Zumo 550, Zumo 660 and Nüvi series.

SP26** & 2720 owners will need to purchase the Garmin Motorcycle Mount.

Colour: Anodized Silver

In order to provide the necessary distance from the screen you need the Zumo adaptor for all Garmin and BMW Navigators (article: Zumo-Ad).



ArtNo.	Description	Price
44007	GPS Mounting	€ 79,90
Zumo-Ad	Adapter for Garmin Zumo This adapter is made for all Garmin SPIII, SP26**, 2720 & Zumo. With this adapter the GPS is 12mm closer to you and it can be dislocated 7,5mm or 15mm higher or lower as usual. You need this option for the Zumo's bus bar. Made of black Pom incl. all screws.	€ 9,95
tomtom-Ad	Adapter for TomTom Rider Incl. screws for mounting in the GPS mount and the TomTom holder.	€ 9,55
tomt-Ad Ed 2	Adapter für TomTom 2nd Edition Incl. screws for mounting in the GPS mount and the TomTom holder.	€ 14,90
ram-1zoll	Adapter for 1" Ram-Ball	€ 29,90

You can find the latest products and bargains
online: www.mhornig.com

Sidestand foot enlargement

Feel safer parking your bike on dirt or asphalt with a sidestand foot enlargement.

More than 100% bigger contact area.

Made of high quality aluminium.

Black anodized.

Easy to install.



The pictures show the higher version article 0718 and article 0718-20. This one is about 20mm high (10mm can easily be screwed on or off) and makes your bike stand more upright, much less effort to get ready for riding. Especially when you ride with luggage.

ArtNo.	Description	Price
0718	Sidestand foot enlargement normal version	€ 25,90
0718-20	Heightening	€ 6,80



Frame cover

This cover for the open hole beyond the swing arm pivot is made of aluminium and available in different versions. It gets fixed on the left side.

ArtNo.	Description	Price
0340	polished	€ 12,45
0440	anodized	€ 12,80
0441	black anodized	€ 12,80



Brake Pedal Enlargement

It is nicely machined of aluminium and natural anodized. The surface is slotted in order to avoid slipping. This enlargement simply slips on and is held in place with two set-screws.

ArtNo.	Description	Price
0102	Brake Pedal Enlargement	€ 30,50



Rear wheel centre cover

Rear wheel centre lug cover with emblem.

The holes in the covers serve for cooling! The lower temperature is based on the special angles of the drillings, which cause a little bit more concentrated air flow, but don't be worried it doesn't affect the drivability of your BMW.

ArtNo.	Description	Price
0116	polished	€ 61,90
0216	anodized	€ 62,90
0316	black anodized	€ 63,40





Axle pivot Cover

This cover for the axle pivot for all new R1200, K1200 and K1300 bikes gives a nice looking finish to the rear end and gives your motorcycle a classy look.

ArtNo.	Description	Price
0072	polished	€ 21,90
0172	anodized	€ 21,90
0272	black anodized	€ 21,90



Centre cap with Emblem

Made of aluminium with emblem. Changeover instructions are included in delivery.

ArtNo.	Description	Price
0084	polished	€ 22,50
0284	anodized	€ 22,90



Stainless steel end weight

These end weights are made of Stainless steel and create a noble look for your bike. Included are two S/S-end weights and two S/S-countersunk screws M8 for fixing. For K1300GT.

ArtNo.	Description	Price
0451	1 Set Stainless steel end weight	€ 30,95



Shift lever extension

Many BMW riders think that their shift lever is a little too thin and doesn't give enough grip when they're shifting.

This enlarger will solve this problem for you as it offers more grip and a more sporty look for your bike.

Available in polished or anodized.

ArtNo.	Description	Price
0190	polished	€ 21,40
0390	anodized	€ 21,80
0195	polished with o-rings	€ 23,50
0395	anodized with o-rings	€ 23,90
19x3	O-ring	€ 0,65

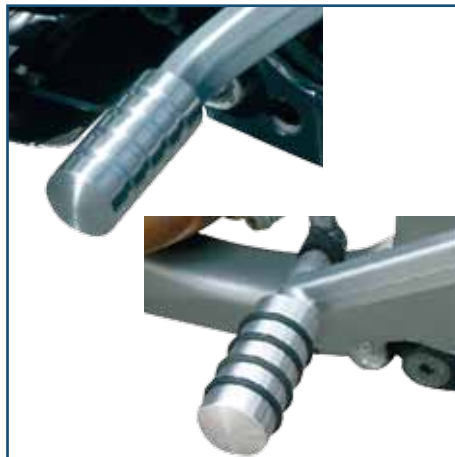

Synto brake- and clutch lever

Synto is the name of the 6x adjustable CNC high-precision brake and clutch made of aluminium.

Combines elegance and functionality. Handling pure!

* 6 x adjustable CNC high-precision levers

* Racing proven Extremely light weight / 60g per lever

* CNC milled from high tech aeronautical norm

aluminium EN 2017

* Perfect design - convincing finish

* Brilliant control feeling * Aerodynamic louver

* Levers ca. 2 cm shorter than original

* Predetermined breaking point at long version

* Adjuster colour is always black, only the black lever has

a silver adjuster * For brake and clutch

* Including street homologation TÜV part certificate (ABE)

There is a video for this product online: www.mhornig.com

ArtNo.	Description	Price
BH27-BKH1-15-11-L	black-silver	€ 218,00
BH27-BKH1-17-15-L	red-black	€ 218,00
BH27-BKH1-14-15-L	blue-black	€ 218,00





V-Stream Windshield

The „V-Stream“ Windshield set new standards for design, technology and comfort.

Made of Quantum/Lexan Polycarbonate which is 10x more scratch-resistant than usual Acrylic.

The windscreen will be shipped with everything you need to mount it.

Windshield V-Stream, clear, with homologation,

ArtNo.	Description	Price
115107	Height 64cm, Width 60cm	€ 219,00
Z2453	Height 68cm, Width 60,5cm	€ 259,00

K Sticker

This 4-piece K Sticker is especially designed for your BMW K1300GT in order to give your luxury tourer a distinctive and individual look. Made of high quality foil which can be easily applied. For left and right.

ArtNo.	Description	Price
k13gt-anthrazit	1 Set anthracite K Sticker	€ 79,90
k13gt-silver	1 Set silver K Sticker	€ 79,90
00WZ02	Ductor with felt	€ 2,95

You can find
more accessories
www.mhornig.com



Front lifter

Our front lifter fits BMW K1300GT.
It is perfect for care, overwinter and servicing.
Made of steel 35x35mm, zinc-plated and quality
„Made in Germany“.

ArtNo.	Description	Price
2039-80II	Front lifter	€ 98,80



Back lifter

Slide the rubber coated pipe of the Back lifter in the final drive of your BMW and lift it up. Easy to use by one person and very stable support for the bike.
Made of high quality steel. Diameter 42mm, zinc-plated.
The diameter of the rubber is 52,5mm.

ArtNo.	Description	Price
BT.heck-lifter	Back lifter	€ 89,90



Indicator bulb

Either orange or special coated bulbs for the rear indicators. The special coated one only lights orange when you use the indicator (usually used with transparent lenses).
Single.

ArtNo.	Description	Price
BLWB	orange bulb 12V/21W rear	€ 2,45
BLWBT	special coated bulb 12V/21W rear	€ 9,90

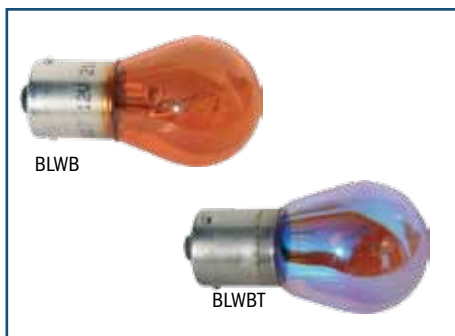

Clear indicator Lenses

Not only street legal with E-mark but also looks very nice and sporty. Incl. orange Bulbs.
Fits K1300GT front.

ArtNo.	Description	Price
WLB-59	1 Set clear indicator lenses	€ 69,90
WLB-59g	1 Set grey indicator lenses	€ 69,90
WLG-05	1 Piece orange bulb	€ 4,95



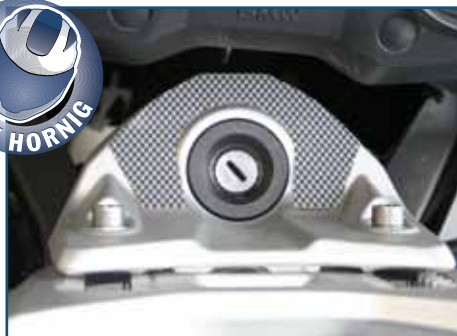

Dash pad

Carbon look - protects this very visible part of your bike from your keys and enhances its appearance with this scratch resistant, self adhesive pad.

ArtNo.	Description	Price
80064	Dash pad	€ 10,45



Carbon Clutch Cover

Small, but very strong clutch protector. Made of carbon fibre.

ArtNo.	Description	Price
KDO.016.K120S.K	Clutch Cover	€ 89,90



Remus HexaCone

More than 4kg lighter compared to the original exhaust. Not only nice for the eyes but also powerful sound - the HexaCone.

Available with three covers:

High-grade Steel, Carbon Fibre or Titanium

There is a video for this product online: www.mhornig.com

ArtNo.	Description	Price
154682 088305	High-grade Steel incl. Cat.	€ 657,00
154882 088305	Titanium incl. Cat.	€ 719,00

Fork-Crash-Pads

These crash-pads for forks are made of cnc lathed plastic (Nylon). The mounting is made of cnc milled and anodized aluminium.

These crash pads provide additional protection for your fork.

Shipment includes the crash pads (left and right) and the mounting.

ArtNo.	Description	Price
FP100	Fork-Crash-Pads	€ 49,00



**How do you sit on your motorcycle seat?
Do you want to change something?**

Then read through the pages of the catalog
SEAT ALTERATION.

We will change your seat exactly like you want it to be.

You must send
your seat
to us!

You need a Tank bag, Tear Seat Bag, Duffel Bag,
Inside Bag, Universal Bag or Tool Bag?
You can find it under **SOFT BAGS** in the catalog
and online: www.mhornig.com



K 1300 S



K1300S

built since 2009

1293 ccm cylinder capacity

power: 175 PS

max. torque 140 Nm

at 8.250/min.

Brake Pedal Enlargement

It is nicely machined of aluminium and natural anodized.

The surface is slotted in order to avoid slipping.

This enlargement simply slips on and is held in place with two set-screws.

ArtNo.	Description	Price
0102	Brake Pedal Enlargement	€ 30,50



Axle pivot Cover

This cover for the axle pivot for all new R1200, K1200 and K1300 bikes gives a nice looking finish to the rear end and gives your motorcycle a classy look.

ArtNo.	Description	Price
0072	polished	€ 21,90
0172	anodized	€ 21,90
0272	black anodized	€ 21,90



Bar-end weights

These bar-end weights made of Stainless steel or aluminium show that BMW riders are aware of function and form.

Article number: 0805 stainless steel 220 gram each

Article number: 0806 aluminium 84 gram each

Shipment: 2 end weights, 2 screws.

ArtNo.	Description	Price
0805	1 Set Stainless steel	€ 32,90
0806	1 Set Aluminium anodized	€ 25,90



Superbike handlebars

These handlebars create a new sporty looking and improve the handling of your bike. The mounting kit is made of high quality aluminium and the bars are especially designed for the BMW K1300S.

Width of the handlebar is ca. 770mm.

ArtNo.	Description	Price
S50130940406	Superbike handlebars	€ 469,00





Speedometer trim

The polished rings for the speedometer and the rev counter are an optical improvement for your K1300S.

Simply stick them to the speedometer and they can be removed without any residue.

ArtNo.	Description	Price
0406	1 Set polished	€ 49,95
0406-1	1 Set anodized	€ 51,40
s2ml	Silicone 2ml	€ 0,40



Frame Cover

Cover for the hole above the swing arm journal.

Available in polished, anodized and black anodized version.

ArtNo.	Description	Price
0352	polished	€ 12,20
0453	anodized	€ 12,60
0454	black anodized	€ 12,95



Main Stand

With EG/ABE. This main stand is characterised by its accuracy of fit and stability. It is very simple to fit on your bike - just like changing the brake pads and so on...

When you use an engine spoiler e.g. for the K1300S slight modifications are required.

Instructions are included.

ArtNo.	Description	Price
HPS.07.634.10000/B	Main Stand	€ 129,95



Sidestand foot enlargement

Feel safer parking your bike on dirt or asphalt with a side stand foot enlargement.

More than 100% larger contact area.

Made of high quality aluminium.

Black anodized.

Easy to install.

ArtNo.	Description	Price
0707	Sidestand foot enlargement	€ 23,90

Shift lever extension

Many BMW riders think that their shift lever is a little too thin and doesn't give enough grip when they're shifting.

This enlarger will solve this problem for you as it offers more grip and a more sporty look for your bike.

Available in polished or anodized.

ArtNo.	Description	Price
0190	polished	€ 21,40
0390	anodized	€ 21,80
0195	polished with o-rings	€ 23,50
0395	anodized with o-rings	€ 23,90
19x3	O-ring	€ 0,65



Rear wheel centre cover

Rear wheel centre lug cover with emblem.

The holes in the covers serve for cooling! The lower temperature is based on the special angles of the drillings, which cause a little bit more concentrated air flow, but don't be worried it doesn't affect the drivability of your BMW.

ArtNo.	Description	Price
0116	polished	€ 61,90
0216	anodized	€ 62,90
0316	black anodized	€ 63,40



Adjustable Foot pegs

The Vario Footrest System (Joint) will be mounted to the motorcycle like the original footpeg.

The adjustable Footrest system consists of 3 parts: Vario Joint, Vario Plate and the Footrest.

All Items sold as a set for left and right.



Part 1

The Vario Footrest System (Joint) will be mounted to the motorcycle like the original footpeg. The Joint is silver anodized.



Part 2

The Vario Plate is the part between the Footpeg and the Vario Footrest System (Joint). The Vario Plate is available in 3 length. We recommend 50mm only for the pillion rider.



ArtNo.	Description	Price
051 02 03 00	Driver Vario Footrest System	€ 41,90
051 02 03 10	Pillion rider Vario Footrest System	€ 41,90
051 00 00 23	23mm Vario Plate	€ 44,50
051 00 00 30	30mm Vario Plate	€ 44,90
051 00 00 50	50mm Vario Plate (only pillion rider)	€ 45,90
050 00 04 00 8	Super Grip Footrest black	€ 51,80
050 00 04 00 1	Super Grip Footrest silver	€ 51,70
050 00 01 00 8	Rascing Footrest black	€ 29,90
050 00 01 00 1	Racing Footrest silver	€ 29,95

Part 3

The Footpeg will be mounted to the Vario Plate. The Super Grip Footpegs are available in silver with black rubber.

The Racing Footpegs are available in black or silver. All Items sold as a set for left and right.



Cover

Covers for the fluid reservoirs.

You simply stick them onto the fluid reservoirs. Can be removed them without residue.

Made of high quality aluminium.

They are sold in a set of two.

ArtNo.	Description	Price
0700	1 Set polished	€ 39,80
0701	1 Set anodized	€ 39,90
0702	1 Set black anodized	€ 39,95
s2ml	Silicone 2ml	€ 0,40

Synto brake- and clutch lever

Synto is the name of the 6x adjustable CNC high-precision brake and clutch made of aluminium. Combines elegance and functionality. Handling pure!

- * 6 x adjustable CNC high-precision levers
 - * Racing proven Extremely light weight / 60g per lever
 - * CNC milled from high tech aeronautical norm aluminium EN 2017
 - * Perfect design – convincing finish
 - * Brilliant control feeling * Aerodynamic louver
 - * Levers ca. 2 cm shorter than original
 - * Predetermined breaking point at long version
 - * Adjuster colour is always black, only the black lever has a silver adjuster * For brake and clutch
 - * Including street homologation TÜV part certificate (ABE)
- There is a video for this product online: www.mhornig.com



ArtNo.	Description	Price
BH27-BKH1-15-11-L	black-silver	€ 218,00
BH27-BKH1-17-15-L	red-black	€ 218,00
BH27-BKH1-14-15-L	blue-black	€ 218,00

Mirror Extensions

Our Mirror Extensions per 25mm are the perfect solutions if you see mainly your shoulders in the mirrors. The mirrors will be moved a few centimetres out in order to improve the view to the rear.

ArtNo.	Description	Price
BK 05	Mirror Extensions	€ 49,95



GPS Mounting

Plug for BMW handlebars with inside diameter of 12mm. Just insert the CNC machined plug in the open part of the handlebar (usually closed with a plastic plug).

The plug will stay in place thanks to an expansion fastener. Almost any navigation system can be fixed on the Ram-ball of this GPS Mounting.

Colour: Black

ArtNo.	Description	Price
NH 3/1	Black Plug	€ 34,95



You can find the latest products online:
www.mhornig.com



Front lifter

Our front lifter fits BMW K1300S.
 It is perfect for care, overwinter and servicing.
 Made of steel 35x35mm, zinc-plated and quality
 „Made in Germany“.

ArtNo.	Description	Price
2039-80II	Front lifter	€ 98,90



Back lifter

Slide the rubber coated pipe of the Back lifter in the
 final drive of your BMW and lift it up. Easy to use by one
 person and very stable support for the bike.
 Made of high quality steel. Diameter 42mm, zinc-plated.
 The diameter of the rubber is 52,5mm.

ArtNo.	Description	Price
BT.heck-lifter	Back lifter	€ 89,90



Clear indicator lens

Clear indicator lenses. Sold in a set (2 pieces).

And if you want, also single.

With E-Mark, so they are homologated for the EU.

Shipping: 2 lenses incl. orange bulbs.

ArtNo.	Description	Price
CTS-0037	Clear indicator lens	€ 20,90
CTS-0037-g	Grey indicator lens	€ 20,95



Clear lenses

Clear or grey lenses for the front indicator indicators with

2 orange bulbs for the K1300S.

Replacement bulb with orange coating 12V/16W.

NEW! With European approval mark

ArtNo.	Description	Price
400.10.20w	1 Set clear lenses	€ 69,90
400.10.20g	1 Set grey lenses	€ 69,90



LED turning signals

Awesome brightness, fitted in seconds and including electronics on the back of the panel to ensure the correct flash rate. It is the complete turning signal and has a

homologation. So it is the first road legal LED for BMW

bikes! The LEDs flash yellow.

Sold in pairs (for left and right).

ArtNo.	Description	Price
01006	1 pair of LED turning signals with clear lenses	€ 89,95
01006-g	1 pair of LED turning signals with grey lenses	€ 89,95



Indicator bulb

Either orange or special coated. The special coated one

only lights orange when you use the indicator

(usually used with transparent lenses). Single.

ArtNo.	Description	Price
BLWB-CBUS	orange bulb 12V/10W	€ 2,55
BLWBT-CBUS	special coated bulb 12V/10W	€ 5,99
10031086	orange coated bulb 12V/16W front	€ 4,15
WLG-194	chrome colour bulbs 12V/16W front	€ 7,90





Touring screen

The touring shield has the same shape as the original, but with an additional raised wind deflector about 5-7 cm high at the top, covering the entire width. This deflects the wind over the rider and allows a relaxed ride, particularly on longer trips.

Length: 415mm

ArtNo.	Description	Price
T-k1200s-rg	Smoke grey	€ 79,90
T-k1200s-k	Clear	€ 79,90
T-k1200s-sw	Black	€ 79,90



Vario touring screen

This type of touring screen has a small spoiler at the top of the wind deflector. Can be manually set to seven positions in terms of angle and height. Tiresome turbulence is also reduced by the air flow at the rear of the spoiler.

Length: 435mm

ArtNo.	Description	Price
VT-k1200s-rg	Smoke grey	€ 119,90
VT-k1200s-k	Clear	€ 119,90



Original shape screen

This wind screen has the same shape like the original windscreen but is available in different colours. Length 350mm, with ABE.

Available in clear, smoke grey and black.

ArtNo.	Description	Price
O-K1200S-rg	Smoke grey	€ 69,90
O-K1200S-k	Clear	€ 69,90
O-K1200S-s	Black	€ 69,90

Spoiler screen

This screen also comes up with the original screen but with a small lip edge at the top.

The spoiler screen will be delivered with ABE, length: 370mm

ArtNo.	Description	Price
S-k1200s-rg	Smoke grey	€ 79,90
S-k1200s-k	Clear	€ 79,90
S-k1200s-sw	Black	€ 79,90



Racing screen

The racing screen has basically the same shape as the original one, with a little hump in the middle, to reduce the wind pressure on the helmet.

With ABE, length: 405mm.

ArtNo.	Description	Price
R-k1200s-rg	Smoke grey	€ 79,90
R-k1200s-k	Clear	€ 79,90





Carbon Clutch Cover

Small, but very strong clutch protector.
Made of carbon fibre.

ArtNo.	Description	Price
KDO.016.K120S.K	Clutch Cover	€ 89,90



Carbon Exhaust Protector

High quality carbon fibre, best workmanship,
sporty look.
Maximum weight saving and easy to install
Fits only the original exhaust!

ArtNo.	Description	Price
ABV.002.K130S.K	Exhaust Protector	€ 139,90



Carbon Front Fairing

Our Carbon Front fairing is made of high quality carbon fibre and gives your bike the unique race track look. It saves a lot of weight and is very easy to mount.

ArtNo.	Description	Price
VE0.003.K120S.K	Front Fairing	€ 499,90



Carbon front fairing covers on the light

High quality carbon fibre
Best workmanship
Sporty look
Maximum weight saving
Easy to install

ArtNo.	Description	Price
VE0.006.K130S.K	Front fairing covers on the light	€ 179,90

Carbon Engine Spoiler

Made of high quality carbon fibre.
The lower part is closed as used for racing.
Fits the BMW K1300S.

ArtNo.	Description	Price
VEU.003.K120S.K	Engine Spoiler Long version	€ 699,90
VEU.012.K120S.K	Engine Spoiler Short version	€ 699,90



(Image: Long version)

Carbon Rear Light Cover

This rear light cover is made of high quality carbon fibre
and available in two versions:
with or without holes for handgrips.

ArtNo.	Description	Price
RHO.008.K120S.K	Rear Light Cover with holes	€ 339,90



Carbon Reservoir-Cover Kit

Cover Kit for reservoirs of brake and clutch fluid reservoirs
with carbon surface. The carbon fibre parts are precisely
shaped and are to be fitted by glue.

ArtNo.	Description	Price
400.10.40	1 Set Reservoir-Covers	€ 59,00
s2ml	Silicone 2ml	€ 0,40



Carbon Front mudguard

This front mudguard is an optical improvement
for your BMW K1300S.
Made of carbon fibre.

ArtNo.	Description	Price
KVO.002.K120S.K	Front mudguard	€ 229,90





Carbon Rear Hugger

Provides ultimate protection for the rear shock absorber. Spend less time cleaning, more time riding!

Fits BMW K1300S. (190/55er tires).

ArtNo.	Description	Price
KHO.101.K130S.K	Rear Hugger	€ 269,90



Carbon Fuel Tank Fairing

This Fuel Tank Fairing is made of high quality carbon fibre and protects your tank from scratches. The items are specially made for your BMW K1300S.

The Fuel Tank Fairing Kit consisting of two parts.

ArtNo.	Description	Price
TAO.010.K120S.K	Battery cover & fuel tank middle part (2 parts)	€ 339,90
BAH.009.K120S.K	Battery Cover	€ 139,90



Carbon Heel guards

Heel guards made of carbon fibre. A small and highly visible enhancement. Very easy to install. Sold in a set for the left and right.

ArtNo.	Description	Price
FSO.004.K120S.K	1 Set Heel guards	€ 149,90



Fork-Crash-Pads

These crash-pads for forks are made of cnc lathed plastic (Nylon). The mounting is made of cnc milled and anodized aluminium.

These crash pads provide additional protection for your fork.

Shipment includes the crash pads (left and right) and the mounting.

ArtNo.	Description	Price
FP100	Fork-Crash-Pads	€ 49,00

Remus Hexacone

More than 2,5 kg lighter compared to the original exhaust. Not only nice for the eyes but also powerful sound - the HexaCone.

Available with two covers: Stainless steel or Titanium.

There is a video for this product online: www.mhornig.com

ArtNo.	Description	Price
094652 088509	Hexacone, slip on, Stainless Steel	€ 675,00
094852 088509	Hexacone, slip on, Titanium	€ 758,00



How do you sit on your motorcycle seat? Do you want to change something?

Then read through the pages of the catalog

SEAT ALTERATION.

We will change your seat exactly like you want it to be.



You need a Tank bag, Tear Seat Bag, Duffel Bag,
Inside Bag, Universal Bag or Tool Bag?

You can find it under **SOFT BAGS** in the catalog
and online: www.mhornig.com





K1600GT & GTL

built since 2011

1600 ccm cylinder capacity

power: 160 PS

Remus HexaCone

More than 4kg lighter compared to the original exhaust.
Not only nice for the eyes but also powerful sound - the HexaCone.

Available with three covers: Stainless Steel, Carbon Fiber or Titanium

ArtNo.	Description	Price
054682 089911LR	Stainless Steel	€ 1080,00
054882 089911LR	Titanium	€ 1204,00
054482 089911LR	Carbon Fiber	€ 1234,00



Side stand foot enlargement

Feel safer parking your bike on dirt or asphalt with a side-stand foot enlargement. More than 100% bigger contact area. Made of high quality aluminium.

Black anodized.
Easy to install.

ArtNo.	Description	Price
0723	Side stand foot enlargement	€ 26,90



Spoiler for windshields

The MRA X-creen spoiler can be set your individual needs in order to eliminate turbulence, wind pressure or annoying noises. The spoiler can be adjusted with two independently adjustable pivot points. The spoiler is 36cm wide and 16.3cm high and available in clear or smoke gray with EU homologation for the original windshield and all MRA windshields! The spoiler can either be screwed or clamped with an extra bracket. Screwed: The attachment of the X-creen-Spoiler via four screws. The existing screen must be drilled for this purpose. Clamped: The X-creen-spoiler is clamped with a special holder on the existing screen (Picture 3). This mounting needs no drilling or gluing. This bracket is not part of the standard product range of the X-creen and must be purchased separately. The distance between the two black mountings which will be screwed to your screen is 25cm. If you use the clamps your windshield needs to be at least 28cm wide on the top.



ArtNo.	Description	Price
4025066125036	clear	€ 99,90
4025066125043	smoke grey	€ 99,90
4025066125074	Clamps	€ 19,90

Find all products for your K1600GT and GTL online:
www.mhornig.com



R850/1100/1150GS & Adventure

built since 1994/1998/1999/2002

848/1085/1130 ccm cylinder capacity

power: 70/80/85 PS

GPS Mounting

Fast, easy mounting is possible with our new GPS Mount for BMW R1100, 1150GS & Adventure.

No Vibrations!

For all BMW Navigators, Garmin Zumo, SP111, SP26**, 2720, Zumo 550, Zumo 660 and Nüvi series. GPS SP26** & 2720 owners will need to purchase the Garmin Motorcycle Mount.

Colour: Anodized Silver



ArtNo.	Description	Price
44004	GPS Mounting BMW R1100, 1150GS & Adv.	€ 38,90
tomtom-Ad	Adapter for TomTom Rider Incl. screws for mounting in the GPS mount and the TomTom holder.	€ 9,55
tomt-Ad Ed 2	Adapter for TomTom 2nd Edition Incl. screws for mounting in the GPS mount and the TomTom holder.	€ 14,90
ram-1zoll	Adapter for 1" Ram-Ball	€ 29,90

Mirror Heightening

Our Mirror Heightening are the perfect solution when you see mainly your shoulders in the rear mirrors. The mirrors will be moved 2,5 centimeters (R1150R) or 3,0 centimeters (R850/1100R) higher and that creates the necessary space in order to improve the view to the back.

ArtNo.	Description	Price
BK 00	1 Set Mirror Risers R1150GS & Adv.	€ 19,90
BK 00lr	1 Set Mirror Risers R850/1100GS	€ 19,90



Key holder with emblem

Useful key holder made of knurled aluminium, polished on top, with our emblem.

Just slot in the „Emergency key“ and fix with a setscrew.
0076 : Also possible to hook in a carabiner.

ArtNo.	Description	Price
0075	polished without eye	€ 19,90
0076	polished with eye	€ 28,50



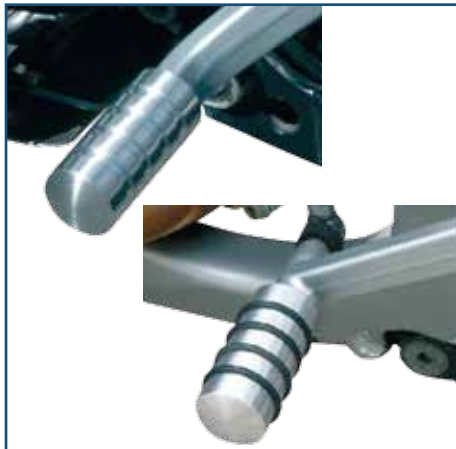

Shift lever extension

Many BMW riders think that their shift lever is a little too thin and doesn't give enough grip when they're shifting. This enlarger will solve this problem for you as it offers more grip and a more sporty look for your bike. Available in polished or anodized.

ArtNo.	Description	Price
0190	polished	€ 21,40
0390	anodized	€ 21,80
0195	polished with o-rings	€ 23,50
0395	anodized with o-rings	€ 23,90
19x3	O-Ring	€ 0,65



Brake pedal enlarger

- brake pedal enlargement till 08/97 (0130+0130-1)
 - brake pedal enlargement since 09/97 (0140+0140-1)
 This special part is made of extremely handy aluminium and cares for safe braking. It gets mounted with two screws, u-screws, nut and hulls which are all yet with the enlargement.

You can download the install instruction online!

ArtNo.	Description	Price
0130	Aluminium	€ 18,90
0130-1	anodized	€ 18,95
0140	Aluminium	€ 18,95
0140-1	anodized	€ 19,90

Handlebar Risers

Handlebars rise by 25 mm for R850/1100/1150GS

- For an upright and relaxed riding position
- Less strain on shoulders and wrists
- For sport bikes: Better standing, less exhaustive riding
- Better handling
- Black plastic coating
- German TÜV Type Approval

When using the original BMW fog lamps, you also require our special screw screw-set (040-0272).

ArtNo.	Description	Price
040-0265	Handlebar Risers 25mm	€ 39,90
040-0272	Special screw-set 2x M8 x 65 with M4 thread	€ 19,90





Speedometer trim

These polished rings for your speedometer and your rev counter are an optical improvement for your GS, RT or RS. Just stick on with glue or some silicone. May be removed without residue. Consists of a set of both rings.



ArtNo.	Description	Price
0400	1 Set polished	€ 39,90
0401	1 Set anodized	€ 42,90
s2ml	Silicone 2ml	€ 0,40

Camshaft lid

Made of high quality aluminium and fits all four valve twins as a replacement for the original plastic cap. The delivery occurs as a set of two caps with the o-rings and screws.



ArtNo.	Description	Price
0160	1 Set polished	€ 29,90
0360	1 Set anodized	€ 29,95
60010	S/S Round Head Screws (you need 4 screws)	€ 0,40

Telelever end caps

These telelever end caps add a new optical highlight on your BMW. Nice form and robust material. Always sold as a set in polished or anodized version.



ArtNo.	Description	Price
0090	1 Set polished	€ 26,70
0290	1 Set anodized	€ 26,90

Foot peg plate

Besides providing a nice, finished look, these covers help to keep dirt and grime away from the pivots. They are made of aluminium. Installation is simple: just insert the stem into the pivot and tighten the central Allen screw to expand the retaining sleeve. 2 pieces = 1 set.

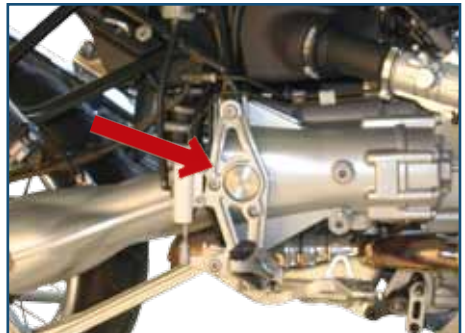

ArtNo.	Description	Price
0310	1 Set polished	€ 24,60
0410	1 Set anodized	€ 24,90



Rear Wheel Hub Cap

Nice cover for the rear wheel hub which is made of high quality aluminium.

Available in polished or in anodized. Delivery includes a set of the cover, the installation kit and the mounting guidelines.

You can also download how to install it online!

ArtNo.	Description	Price
0110	polished	€ 39,00
0210	anodized	€ 39,50



Cooler protection

Perfect protection for your oil cooler with nice design, made of high-quality aluminium for the R1150GS & Adv.

The lattice is surrounded by a solid frame and keeps insects and dirt away from the oil cooler.

Installation instructions included.

ArtNo.	Description	Price
8160363	anodized	€ 29,90
8160363-s	black	€ 34,90



Oil filler plug with emblem

There is a drilling in the side of the plug in which you can put a size 3 Allen key or a Torx key T10 (usually found in your BMW toolkit) in order to fit and remove it.

ArtNo.	Description	Price
0040	polished	€ 24,80
0240	anodized	€ 24,90
0055	black anodized	€ 25,90
10011	O-ring	€ 1,20



Oil filler plug

This oil filler plug with Allen tool looks absolutely great because of its finish and has good function as a locking plug. Use a size 5 Allen key (usually found in your BMW toolkit) in order to fit and remove.

ArtNo.	Description	Price
0030	polished	€ 19,80
0010	anodized	€ 19,90
0020	black anodized	€ 19,95
10011	O-ring	€ 1,20

Adjustable Foot pegs

The Vario Footrest System (Joint) will be mounted to the motorcycle like the original footpeg.

The adjustable Footrest system consists of 3 parts: Vario Joint, Vario Plate and the Footrest.

All Items sold as a set for left and right.



Part 1

The Vario Footrest System (Joint) will be mounted to the motorcycle like the original footpeg. The Joint is silver anodized.



Part 2

The Vario Plate is the part between the Footpeg and the Vario Footrest System (Joint). The Vario Plate is available in 3 length. We recommend 50mm only for the pillion rider.



ArtNo.	Description	Price
R850/1100GS MY 94-* and R1150GS & Adv. 99-03		
051 02 04 00	Driver Vario Footrest System	€ 41,90
051 02 01 10	Pillion rider Vario Footrest System	€ 41,90
051 00 00 23	23mm Vario Plate	€ 44,50
051 00 00 30	30mm Vario Plate	€ 44,90
051 00 00 50	50mm Vario Plate (only pillion rider)	€ 45,90
050 00 04 00 8	Super Grip Footrest black	€ 51,80
050 00 04 00 1	Super Grip Footrest silver	€ 51,70
050 00 01 00 8	Racing Footrest black	€ 29,90
050 00 01 00 1	Racing Footrest silver	€ 29,95

Part 3

The Footpeg will be mounted to the Vario Plate. The Super Grip Footpegs are available in silver with black rubber.

The Racing Footpegs are available in black or silver. All Items sold as a set for left and right.

Foot brake fluid reservoir cover

Cover for the foot brake fluid reservoir CNC machined of aluminium.

Image shows K1200R.

But it is also visible on: R850/1100/1150GS

ArtNo.	Description	Price
0706	polished	€ 19,90
0706-1	anodized	€ 20,90
s2ml	Silicone 2ml	€ 0,40



Sidestand foot enlargement

Feel safer parking your bike on dirt or asphalt with a side stand foot enlargement.

More than 100% bigger contact area.

Made of high quality aluminium.

Black anodized.

Easy to install.



This Image shows the higher version article 0711 and article 0711-20. This one is about 20mm high (10mm can easily be screwed on or off) Makes your bike stand more upright meaning you need much less effort to get it off the stand before riding. Especially when you ride with luggage.

ArtNo.	Description	Price
R1100/1150GS MY 1998.*		
0711	Sidestand foot enlargement normal version	€ 19,95
0711-20	Heightening	€ 5,90
R1150GS Adv.		
0712	Sidestand foot enlargement normal version	€ 23,95
0712-20	Heightening	€ 5,90



Centre cap top yoke

This part is an optical improvement for your top yoke as it is made of robust aluminium with an emblem.

An integrated o-ring ensures a snug fit.

ArtNo.	Description	Price
0060	polished	€ 24,60
0260	anodized	€ 24,90
0262	black anodized	€ 23,95
0065	polished (without emblem)	€ 18,95
0265	anodized (without emblem)	€ 18,95



Crashbars ZTechnik

ZTechnik's stainless steel Engine Guards will never rust like powder coated steel guards. They are carefully designed to allow clearance for oil changes or valve cover access, so they never need to be removed. Guards attach to the engine mounts not the engine covers to protect the engine heads and not destroy them. Integrated top brackets on each guard allow the rider to mount accessory lights, video cameras, or whatever they can imagine!

BMW R1100GS 93-98

BMW R1150GS 99-03



ArtNo.	Description	Price
Z7105	Crashbars Ztechnik	€ 299,00

Fork tube cover

Nice looking cover for the fork tube which works as a replacement for all plastic caps, kept firmly in place by an o-ring.

In order to replace all plastic caps you get 2 covers in a set.

ArtNo.	Description	Price
0120	1 Set polished	€ 19,90
0220	1 Set anodized	€ 19,95
0221	1 Set black anodized	€ 22,90





Crashbars

Our crashbars are made of high-quality steel and are special designed for your R1100GS, R1150GS & R1150GS Adv. model or newer. The crashbars are designed to be very robust and allow for an equal distribution of forces in a crash. You and your bike are protected in the best possible way.

Crashbars offer a very good protection but they can reduce the cornering angle.

ArtNo.	Description	Price
SBL07.405.100	Crashbars silver R1100GS 93 - 99	€ 179,95
SBL07.409.100	Crashbars silver R1150GS 00 - 04	€ 179,95
SBL07.408.100	Crashbars silver R1150GS Adv.	€ 169,95



Stainless steel end weight

These end weights are made of Stainless steel and create a noble look for your bike. Included are two S/S-end weights and two S/S-countersunk screws M8 for fixing. Fits for R850/1100/1150GS.

ArtNo.	Description	Price
0451	1 Set Stainless steel end weight	€ 30,95



S/S screws

Brake fluid - & clutch reservoir

get a new look with these 4x S/S screws

70070: For all (elderly) Bikes with a hydraulic brake and no hydraulic clutch

70075: For all (newer) Bikes with a hydraulic brake and a hydraulic clutch

ArtNo.	Description	Price
70070	4 x M5x16	€ 3,95
70075	4 x M4x16	€ 3,95

Chrome cap I

The chrome caps for the gear oil filler screw are an optical improvement for your BMW.

You simply push them on. The caps fit into the gear oil filler screw with Allen head and will fit any other screws with the same Allen size.

ArtNo.	Description	Price
0500	Big chrome caps	€ 4,25
0501	Small chrome caps	€ 3,75



Chrome cap II

Chrome cap II was created for covering the gear oil filler screw. Like cap I it is just pushed on and fits perfectly.

ArtNo.	Description	Price
0502	Chrome cap II	€ 3,80



Paralever pivot cap

Effective prevention of dirt is guaranteed by this paralever pivot cap.

Highest quality and a perfect look anodized aluminium. Fits for R1100/1150GS MY 1998-* and R1150GS Adv.

ArtNo.	Description	Price
0070	anodized	€ 12,90

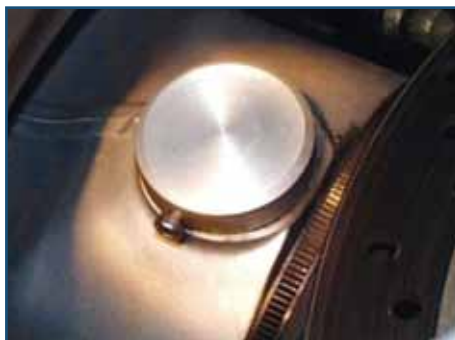



Vario screen maxi

Bigger is better. The two-piece „Maxi Edition“ Varioscreen is larger than the original VarioScreen and offers the same two-piece adjustable design and turbulence-reducing interior wind channel.

Available in smoke grey only.

Bottom of screen is printed with black raster in the same shape as the underlying fairing.

Overall length: 19.7 inches (500 mm).

ArtNo.	Description	Price
VM-r1100gs-rg	Vario screen maxi Smoke grey	€ 159,90

Vario screen

The Varioscreen can be adjusted for angle or height. This screen has an additional wind channel. Because of the wind channel and the adjustment facility, this screen can be adjusted to suit the requirements of the rider.

When you want to install it on a BMW R1150GS Adv. you need original items from the BMW R1150GS:

1x 46632328697, 1x 46632328698, 1x 64637652855, 1x 64637652856, 1x 46632328835, 1x 46632328836, + screws

ArtNo.	Description	Price
V-r1150gs-rg	Vario screen smoke grey	€ 149,90
V-r1150gs-k	Vario screen clear	€ 149,90



V-Stream Windshield

The "V-Stream" Windshield set new standards for design, technology and comfort. Made of Quantum/Lexan Polycarbonate which is 10x more scratch-resistant than usual Acrylic. The windscreen will be shipped with everything you need to mount it.

Windshield V-Stream, light grey, with homologation

When you want to install it on a BMW R1150GS Adv. you need two original items from the BMW R1150GS:

1x 46632328697, 1x 46632328698, 1x 64637652855, 1x 64637652856, 1x 46632328835, 1x 46632328836, + screws

ArtNo.	Description	Price
115109	Height 46 cm, Width 46 cm	€ 189,00
Z2240	Height 55 cm, Width 47 cm	€ 199,00

Windscreen Adventure

The „V-Stream“ Windshield set new standards for design, technology and comfort. Made of Quantum/Lexan Polycarbonate which is 10x more scratch-resistant than usual Acrylic. The windscreen will be shipped with everything you need to mount it.

Windshield V-Stream, with homologation and mounting

ArtNo.	Description	Price
Z2422	clear, Height 58cm, Width 50cm	€ 399,00
Z2423	Light grey, Height 51cm, Width 46cm	€ 369,00



LED turning signal

Awesome brightness, fitted in seconds and including electronics on the back of the panel to ensure the correct flash rate.

It is the complete turning signal and has a homologation.

So it is the first road legal LED for BMW bikes!

The LEDs flash yellow. Sold in pairs.

ArtNo.	Description	Price
0917	1 pair with clear lenses	€ 99,95
0917-g	1 pair with grey lenses	€ 99,95



LED tail light panel

This tail light panel shines far brighter than the standard set up! It is fitted in seconds by anyone.

Features up to 24 red high intensity LEDs and 4 white high intensity LEDs for the number plate.

ArtNo.	Description	Price
10101-01	LED tail light panels without Integral ABS	€ 84,95
10101-02	LED tail light panels with Integral ABS	€ 96,10



Clear tail light lens

Complete Taillight with integrated LED-board for simple exchange! Road legal.

For BMW R850/1100/1150GS & Adv.

For models with and without ABS or Int.ABS.

ArtNo.	Description	Price
WLL-69-L	LED Taillight clear	€ 89,90
WLL-69-L-S	LED Taillight grey	€ 99,90
WL-69	Taillight lens	€ 53,90







Clear indicator lens

These clear indicator lenses give your BMW a quite sporty look.
Supplied as pairs but if you want, also as single items.
Amber bulbs included!

ArtNo.	Description	Price
L30103	1 Set Clear indicator lens	€ 18,95
L30103-g	1 Set Grey indicator lens	€ 18,95



You can find more exhaust for the
R1100GS online: www.mhornig.com

Remus Revolution

R 850/1150 GS 99 model or newer
Perfect Looking, quick and easy Mounting, less Weight,
more Power, more Torque, deep and throaty Sound
combined with ABE (European Homologation) Real riding
pleasure!

ArtNo.	Description	Price
078102 087799	Slip-on exhaust without catalytic , with EG/ABE, Aluminium	€ 709,00
078802 087799	Slip-on exhaust without catalytic , with EG/ABE, Titanium	€ 832,00
078702 087799	Slip-on exhaust without catalytic , with EG/ABE, Stainless steel black	€ 744,00
008102 087799	Slip-on, only exhaust silencer, with EG/ABE, Aluminium	€ 390,00
008402 087799	Slip-on, only exhaust silencer, with EG/ABE, Carbon	€ 513,00
008802 087799	Slip-on, only exhaust silencer, with EG/ABE, Titanium	€ 513,00



Beak enlargement

Award your R1150GS a very sporty and distinctive offroad look with this beak enlargement as well as much better mud protection. It is very easy to install.

ArtNo.	Description	Price
7664390	Beak enlargement	€ 49,90
ha-7664390	Fastening for the Beak	€ 7,40



Carbon Rear Hugger

Provides ultimate protection for the rear shock absorber! Spend less time cleaning and more time riding! The best fit possible is provided by an aluminium fastener. With ABE.

ArtNo.	Description	Price
110310	Rear Hugger	€ 219,90

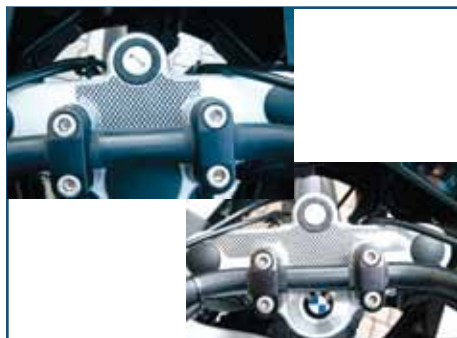

Dash pad

Dash pad in carbon look - protects this very visible part of your bike from key scratches and enhances its appearance. Scratch resistant, self adhesive pad.

ArtNo.	Description	Price
80071	Dash pad large	€ 14,95
80070	Dash pad small	€ 6,65



Carbon starter cover

This starter cover made of carbon fibre will surely become the latest highlight on your BMW. It fits all GS-models. Looks even better in combination with other carbon parts.

ArtNo.	Description	Price
110330	Starter cover	€ 179,00

WP suspension front & rear

Fits for R1100GS

Our WP suspensions will be specially adjusted for you! Because of this please inform us about your weight with clothes and helmet, the weight of your luggage (perhaps pillion rider), where you ride (street, off-road, race) and how you ride (sport, touring, and so on) in the „comment“ of your order.

The Fusion as well as the Emulsion suspension can be combined with the hydraulic preload adjustment. (productnr. /02)

You can choose any spring colour you like.

High/Low speed compression separately adjustable, each 16 times (256 possibilities) (only Spin and Fusion)

suspension rear: adjustable rebound preload adjuster

suspension front: preload adjuster, 16 positions

For riders wanting the upmost from their machine Exceptional cooling properties due to the use of heat diverting aluminium alloys, therefore constant shock absorption and longer life Lightweight through use of high quality materials. Adjustable length is standard

Recognised safety certificate



ArtNo.	Description	Price
17.06.07.29/P7.31	Fusion suspension with reservoir fixed by a steel flex front	€ 899,00
17.06.09.29/P9.31	Emulsion suspension front	€ 549,00
17.06.08.27/P8.67	Fusion suspension with reservoir fixed by a steel flex rear	€ 849,00
17.06.09.27/P9.67	Emulsion suspension rear	€ 549,00
/02	Hydraulic preload adjustment	€ 229,00

WP EDS II System

Fit for R1150GS bikes.

Our WP suspensions will be specially adjusted for you! Because of this please inform us about your weight with clothes and helmet, the weight of your luggage (perhaps pillion rider), where you ride (street, off-road, race) and how you ride (sport, touring, and so on) in the „comment“ of your order.

For extra charge you can choose any spring colour you like.

You now have the option to control the settings of your suspension with the touch of a button. The EDS system comes complete with all necessary parts, including bracket for the control module and an ECM.



ArtNo.	Description	Price
11.06.Y0.02	EDS II System front & rear	€ 1.699,00

Change front and rear seat

R850/1100/1150GS

The drivers and pillion rider's seat are equipped with a fluting in order to release the tail bone. The seats were also broadened for about 15mm.

The padding consists of two layers, the upper one comfortably soft and the lower one avoids denting. We especially took care of the pillion rider's comfort:

Here, the seat is increased in the middle front part to inhibit a cramped position.

These alterations care for a tangible comfortable riding - free from pain. Also the vexatious sliding when the driver brakes has an end now.

Available in three heights (please note in the comment with the article number):

- 1: like the original one
- 2: lower (- ca. 25mm)
- 3: higher (+ ca. 25mm)

Your seat gets altered - you have to send it in!
The change takes about 2 weeks.



ArtNo.	Description	Price
sitzF	Driver's seat black	€ 189,00
sitzS	Pillion's seat black	€ 184,00
s-g	Extra charge black-grey (for each seat)	€ 29,00



Change one-piece seat

For the R1150GS Adv. bikes

A distinct fluting (middle of the seat is deepened) releases the driver's tailbone and disperses the driver's weight all over his bottom. Also, the seat gets broadened for ca.15 mm. The padding consists of two layers, the upper one comfortably soft and the lower one avoids denting. Special contours for the pillion's seat avoid the slipping when the driver has to brake.

Available in three heights (please note in the comment with number):

- 1: like the original one
- 2: lower (- ca. 25mm)
- 3: higher (+ ca. 25mm)

Your seat gets altered - you have to send it in!
The change takes about 2 weeks.

ArtNo.	Description	Price
sb	Seat black	€ 289,00

Multi Box

Oil tank or tool box for your BMW R850/1100GS and R1150GS. The oil tank has a volume of 1 litre. In the tool box you can store lots of items like spark plugs and so on. You have to remove the seat when you want to open the multi boxes, because of that the multi boxes are very safe. Their content will stay dry. The box is made of PE-synthetic material and their weight is about 400 grams. Everything you need to install it is included and you can install it in few minutes.

ArtNo.	Description	Price
ST1010	Multi Box - Oil tank	€ 69,00
ST1020	Multi Box - Tool Box	€ 69,00



You need a Tank bag, Tear Seat Bag, Duffel Bag, Inside Bag, Universal Bag or Tool Bag?
You can find it under SOFT BAGS in the catalog
and online: www.mhornig.com





R850/1100/1150R & Rockster

built since 1994

848/1085/1130 ccm cylinder capacity

power: 70/90/98 PS

max. torque 77/95/100 Nm



GPS Mounting

Handlebar mounting for 22mm handlebars + Ram-Ball
with M10 x 1,25 thread;
CNC machined for TomTom Rider 2 and Garmin Zumo.

Ram-Ball mount may be used for many other items, too.

Colour: Black



With or without hinge in order to move your navigation
system in the best position.

ArtNo.	Description	Price
NH 1/3 sw 22	GPS Mounting without hinge black	€ 34,95
NH 2/1 sw 22	GPS Mounting with hinge black	€ 44,95





Camshaft lid

Made of high quality aluminium and fits all four valve twins as a replacement for the original plastic cap. The delivery occurs as a set of two caps with the o-rings and screws.

ArtNo.	Description	Price
0160	1 Set polished	€ 29,90
0360	1 Set anodized	€ 29,95
60010	S/S Round Head Screws (you need 4 screws)	€ 0,40



Telelever end caps

These telelever end caps add a new optical highlight on your BMW.

Nice form and robust material.

Always sold as a set in polished or anodized version.

ArtNo.	Description	Price
0090	1 Set polished	€ 26,70
0290	1 Set anodized	€ 26,90



Swing arm pivot cover

These covers are the perfect replacement for the original plastic caps. Made of aluminium.

Supplied as a pair.

Fits the R850R from MY 2003 and R1150R from MY 2001.

ArtNo.	Description	Price
0330	1 Set polished	€ 21,60
0430	1 Set anodized	€ 21,90



Fork tube cover

Nice looking cover for the fork tube which works as a replacement for all plastic caps, kept firmly in place by an o-ring.

In order to replace all plastic caps you get 2 covers in a set.

ArtNo.	Description	Price
0120	1 Set polished	€ 19,90
0220	1 Set anodized	€ 19,95
0221	1 Set black anodized	€ 22,90

Shift lever extension

Many BMW riders think that their shift lever is a little too thin and doesn't give enough grip when they're shifting.

This enlarger will solve this problem for you as it offers more grip and a more sporty look for your bike. Available in polished or anodized.

ArtNo.	Description	Price
0190	polished	€ 21,40
0390	anodized	€ 21,80
0195	polished with o-rings	€ 23,50
0395	anodized with o-rings	€ 23,90
19x3	O-ring	€ 0,65

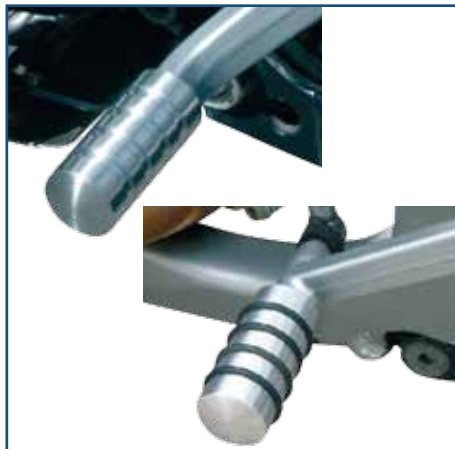

Mirror Heightening

Our Mirror Heightening are the perfect solution when you see mainly your shoulders in the rear mirrors. The mirrors will be moved 2,5 centimeters (R1150R) or 3,0 centimeters (R850/1100R) higher and that creates the necessary space in order to improve the view to the back.

ArtNo.	Description	Price
BK 00	1 Set Mirror Risers R1150R	€ 19,90
BK 00lr	1 Set Mirror Risers R1100R and R850R MY -2000	€ 19,90



Rear wheel centre cover

A cover made of aluminium with emblem. The mounting is quite easy: just put it into the hole of the wheel. Perfect fit is guaranteed by an o-ring.

There are different drillings in the 5-spoke aluminium wheel (please measure!).

ArtNo.	Description	Price
0-300-1	Size 32,3 anodized	€ 18,90
0-301-1	Size 30,5 anodized	€ 18,90
0-303-1	Size 31,8 anodized	€ 18,90
0-300-0	Size 32,3 polished	€ 18,80
0-301-0	Size 30,5 polished	€ 18,80
0-303-0	Size 31,8 polished	€ 18,80





Brake pedal enlargement

This brake pedal enlargement is nicely machined of aluminium, knurled and anodized.

It is quite simple to install - just slip it on and lock in place with a set-screw.

Fit for R850/1100R until 02 model

ArtNo.	Description	Price
0100	Brake pedal enlargement	€ 24,60



Brake pedal enlargement

Nicely machined aluminium, knurled and natural anodized.

This enlargement simply slips on and is held in place with a set-screw.

Suitable for: R1150R,
R850/1100R since 03 model

ArtNo.	Description	Price
0180	Brake pedal enlargement	€ 22,15



Oil filler plug with emblem

There is a drilling in the side of the plug in which you can put a size 3 Allen key or a Torx key T10 (usually found in the your BMW toolkit) in order to fit and remove it.

ArtNo.	Description	Price
0040	polished	€ 24,80
0240	anodized	€ 24,90
0055	black anodized	€ 25,90
10011	O-ring	€ 1,20



Oil filler plug

This oil filler plug with Allen tool looks absolutely great because of its finish and has good function as a locking plug. Use a size 5 Allen key (usually found in the your BMW toolkit) in order to fit and remove.

ArtNo.	Description	Price
0030	polished	€ 19,80
0010	anodized	€ 19,90
0020	black anodized	€ 19,95
10011	O-ring	€ 1,20

Centre cap top yoke

This part is an optical improvement for your top yoke as it is made of robust aluminium with an emblem.

An integrated o-ring ensures a snug fit.

ArtNo.	Description	Price
0060	polished	€ 24,60
0260	anodized	€ 24,90
0262	black anodized	€ 23,95
0065	polished (without emblem)	€ 18,95
0265	anodized (without emblem)	€ 18,95



Crashbars ZTechnik

ZTechnik's stainless steel Engine Guards will never rust like powder coated steel guards. They are carefully designed to allow clearance for oil changes or valve cover access, so they never need to be removed. Guards attach to the engine mounts not the engine covers to protect the engine heads and not destroy them. Integrated top brackets on each guard allow the rider to mount accessory lights, video cameras, or whatever they can imagine!

BMW R1100R 95-03

BMW R1150R 01-06

BMW R1150R Rockster 03-06



ArtNo.	Description	Price
Z7105	Crashbars ZTechnik	€ 299,00

Bar risers

This part will raise your handlebars 25mm, creating a more comfortable riding position, while enhancing the overall handling of your bike. Longer brake line not needed when installing these bar risers.

Set consisting of the bar risers and fitting screws.

Does not fit for bikes with switches on the handle bar!

ArtNo.	Description	Price
0420	1 Set anodized	€ 82,50
0425	1 Set polished	€ 82,60





Handlebar Risers with tube handle bar

Handlebars rise by 25 mm for R850/1100/1150R

- For an upright and relaxed riding position
- Less strain on shoulders and wrists
- For sport bikes: Better standing, less exhaustive riding
- German TÜV Type Approval

When using the original BMW fog lamps, you also require our special screw screw-set (040-0272).

ArtNo.	Description	Price
040-0265	Handlebar Risers 25mm	€ 39,90
040-0272	Special screw-set 2x M8 x 65 with M4 thread	€ 19,90



Short Paralever strut

This paralever (length 365mm) strut is made of high-quality steel and 20mm shorter than the original one. By what you can shorten the wheel base and that improves the handling of your bike eminent. The rear end of the bike will be a little higher as before.

ArtNo.	Description	Price
2314179	Short Paralever strut	€ 84,90



Foot brake fluid reservoir cover

Cover for the foot brake fluid reservoir CNC machined of aluminium. polished.

Image shows K1200R.

But it is also visible on: R850/1100R.

ArtNo.	Description	Price
0706	polished	€ 19,90
0706-1	anodized	€ 20,90
s2ml	Silicone 2ml	€ 0,40



Crashbars

Our crashbars are made of high-quality steel and are special designed for your R 1150 R & Rockster. model or newer (nor R 850 R). The crashbars are designed to be very robust and allow for an equal distribution of forces in a crash. You and your bike are protected in the best possible way.

Crashbars offer a very good protection but they can reduce the cornering angle.

ArtNo.	Description	Price
SBL.07.344.100	Crashbars	€ 179,95

Adjustable Foot pegs

The Vario Footrest System (Joint) will be mounted to the motorcycle like the original footpeg.

The adjustable Footrest system consists of 3 parts: Vario Joint, Vario Plate and the Footrest.

All Items sold as a set for left and right.



Part 1

The Vario Footrest System (Joint) will be mounted to the motorcycle like the original footpeg. The Joint is silver anodized.



Part 2

The Vario Plate is the part between the Footpeg and the Vario Footrest System (Joint). The Vario Plate is available in 3 length. We recommend 50mm only for the pillion rider.



ArtNo.	Description	Price
--------	-------------	-------

For R850R 93-00 and R1100R MY 95-*

051 02 01 00	Driver Vario Footrest System	€ 41,90
--------------	------------------------------	---------

051 02 01 10	Pillion rider Vario Footrest System	€ 41,90
--------------	-------------------------------------	---------

For R850R MY 01-* and R1150R 01-05

051 02 02 00	Driver Vario Footrest System	€ 41,90
--------------	------------------------------	---------

051 02 02 10	Variogelenk für Sozius-Fussrasten	€ 41,90
--------------	-----------------------------------	---------

Vario Plate and Footrest for all models

051 00 00 23	23mm Vario Plate	€ 44,50
--------------	------------------	---------

051 00 00 30	30mm Vario Plate	€ 44,90
--------------	------------------	---------

051 00 00 50	50mm Vario Plate (only pillion rider)	€ 45,90
--------------	---------------------------------------	---------

050 00 08 00 8	Super Grip Footrest black	€ 51,80
----------------	---------------------------	---------

050 00 04 00 1	Super Grip Footrest silver	€ 51,70
----------------	----------------------------	---------

050 00 01 00 8	Racing Footrest black	€ 29,90
----------------	-----------------------	---------

050 00 01 00 1	Racing Footrest silver	€ 29,95
----------------	------------------------	---------

Part 3

The Footpeg will be mounted to the Vario Plate. The Super Grip Footpegs are available in silver with black rubber.

The Racing Footpegs are available in black or silver. All Items sold as a set for left and right.





S/S screws

Brake fluid - & clutch reservoir

get a new look with these 4x S/S screws

70070: For all (elderly) Bikes with a hydraulic brake and no hydraulic clutch

70075: For all (newer) Bikes with a hydraulic brake and a hydraulic clutch

ArtNo.	Description	Price
70070	4 x M5x16	€ 3,95
70075	4 x M4x16	€ 3,95

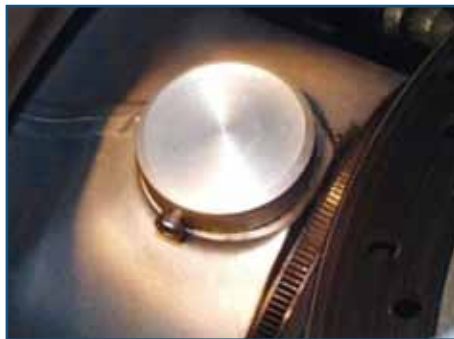

Paralever pivot cap

Effective prevention of dirt is guaranteed by this paralever pivot cap.

Highest quality and a perfect look anodized aluminium.

ArtNo.	Description	Price
0070	anodized	€ 12,90



Chrome cap I

The chrome caps for the gear oil filler screw are an optical improvement for your BMW.

You simply push them on. The caps fit into the gear oil filler screw with Allen head and will fit any other screws with the same Allen size.

ArtNo.	Description	Price
0500	Big chrome caps	€ 4,25
0501	Small chrome caps	€ 3,75



Chrome cap II

Chrome cap II was created for covering the gear oil filler screw.

Like cap I it is just pushed on and fits perfectly.

ArtNo.	Description	Price
0502	Chrome cap II	€ 3,80

Sidestand foot enlargement

Feel safer parking your bike on dirt or asphalt with a side stand foot enlargement.

More than 100% bigger contact area.

Made of high quality aluminium.

Black anodized.

Easy to install.

Fits R 850/1100/1150R.



ArtNo.	Description	Price
0709	Sidestand foot enlargement	€ 23,40

Key holder with emblem

Useful key holder made of knurled aluminium, polished on top, with our emblem.

Just slot in the „Emergency key“ and fix with a setscrew.
0076 : Also possible to hook in a carabineer.

ArtNo.	Description	Price
0075	polished without eye	€ 19,70
0076	polished with eye	€ 28,50



S-Lifter

Our front lifter fits for BMW R1150R, Rockster.

Only useable without an engine spoiler.

It is perfect for care, overwinter, change wheels and servicing.

Made of steel, zinc-plated and quality „Made in Germany“.

ArtNo.	Description	Price
BSL	S-Lifter	€ 75,90
BSL011	BoxerCup-Lifter	€ 129,90



Stainless steel end weight

These end weights are made of Stainless steel and create a noble look for your bike. Included are two S/S-end weights and two S/S-countersunk screws M8 for fixing.

Fits for: BMW R 850/1100/1150R.

ArtNo.	Description	Price
0451	1 Set Stainless steel end weight	€ 30,95





Clear lens + LED

Far brighter than the standard set up!
Fitted in seconds by anyone.
Features up to 24 red high intensity LEDs
Fits for R1150R.

ArtNo.	Description	Price
40106-01	Without Integral ABS	€ 84,95
40106-02	With integral ABS (with or without cruise control)	€ 89,95



LED tail light panel

This tail light panel shines far brighter than the standard set up! It is fitted in seconds by anyone.
Features up to 24 red high intensity LEDs and 4 white high intensity LEDs for the number plate.
Fits for R850/1100R.

ArtNo.	Description	Price
10101-01	LED tail light panels without Integral ABS	€ 84,95



Clear tail light lens

Complete Taillight with integrated LED-board for simple exchange! Road legal.
For BMW R850/1100R.
For models with and without ABS or Int.ABS.

ArtNo.	Description	Price
WLL-69-L	LED Taillight clear	€ 89,90
WLL-69-L-S	LED Taillight grey	@ 99,90
WL-69	Taillight lens	€ 53,90



Clear indicator lens

These clear indicator lenses give your BMW a quite sporty look.
Supplied as pairs but if you want, also as single items.
Amber bulbs included!

ArtNo.	Description	Price
L30103	1 Set Clear indicator lens	€ 18,95
L30103-g	1 Set Grey indicator lens	€ 18,95



LED turning signal

Awesome brightness, fitted in seconds and including electronics on the back of the panel to ensure the correct flash rate.

It is the complete turning signal and has a homologation.

So it is the first road legal LED for BMW bikes!

The LEDs flash yellow. Sold in pairs.

ArtNo.	Description	Price
0917	1 pair with clear lenses	€ 99,95
0917-g	1 pair with grey lenses	€ 99,95

You can find
more accessories
www.mhornig.com



Vario screen

The windscreen Varioscreen is produced and tailored precisely. All screens are forwarded with the exact mounting (Handlebar mount). But screens and mountings are also available separately. VarioScreen windscreens feature Two-piece construction with a two-point handlebar mount for Naked Bikes and Cruisers. The upper portion of the windscreen can be adjusted (+/- 2 inches) to various heights to suit the rider's taste and smooth out airflow. Available in clear or smoke grey.

ArtNo.	Description	Price
For R850R *-2000 and R1100R		
VNBr1100r-k	Vario screen clear	€ 169,90
VNBr1100r-rg	Vario screen smoke grey	€ 169,90
For R850R 2001-.* and R1150R		
VNB-boxer-k	Varioscreen clear	€ 169,90
VNB-boxer-rg	Varioscreen smoke grey	€ 169,90



Roadshield

The windscreen Roadshield is produced and tailored precisely. All screens are forwarded with the exact mounting (Handlebar mount). But screens and mountings are also available separately.

ArtNo.	Description	Price
For R850R *-2000 and R1100R		
R0r1100r-k	Roadshield clear	€ 94,90
R0r1100r-rg	Roadshield smoke grey	€ 94,90
For R850R 2001-* and R1150R		
RO-boxer-k	Roadshield clear	€ 94,90
RO-boxer-rg	Roadshield smoke grey	€ 94,90

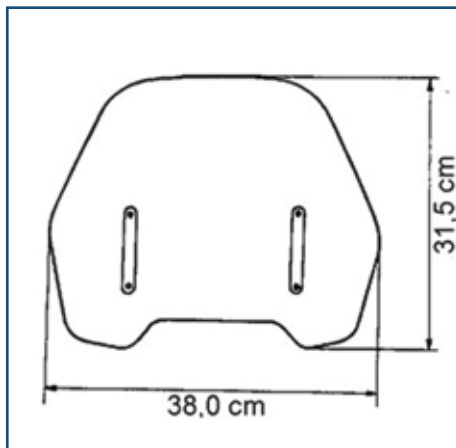

Highwayshield

The windscreen Highwayshield is produced and tailored precisely. All screens are forwarded with the exact mounting (Handlebar mount). But screens and mountings are also available separately.

ArtNo.	Description	Price
For R850R *-2000 and R1100R		
Hlr1100r-k	Highwayshield clear	€ 109,90
Hlr1100r-rg	Highwayshield smoke grey	€ 109,90
For R850R 2001-* and R1150R		
HI-boxer-k	Highwayshield clear	€ 109,90
HI-boxer-rg	Highwayshield smoke grey	€ 109,90

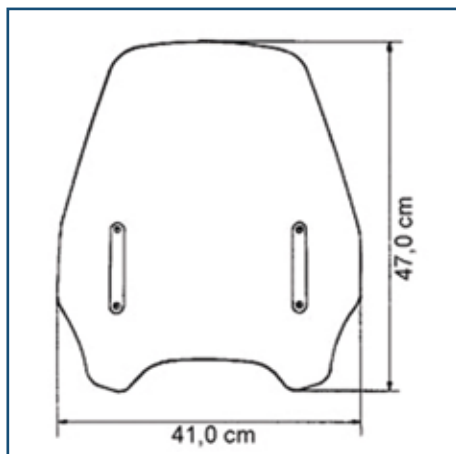

Customshield

The windscreen Customshield is produced and tailored precisely. All screens are forwarded with the exact mounting (Handlebar mount). But screens and mountings are also available separately.

ArtNo.	Description	Price
For R850R *-2000 and R1100R		
CUr1100r-k	Customshield clear	€ 109,90
CUr1100r-rg	Customshield smoke grey	€ 109,90
For R850R 2001-* and R1150R		
CU-boxer-k	Customshield clear	€ 109,90
CU-boxer-rg	Customshield smoke grey	€ 109,90

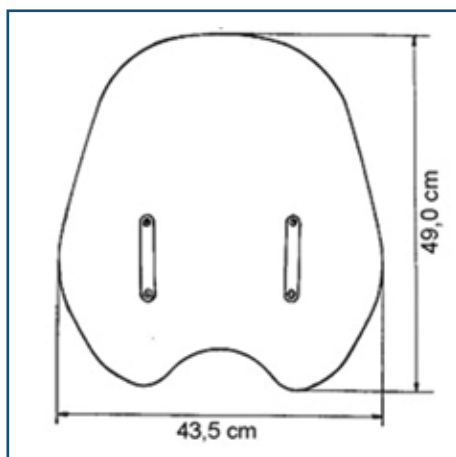



Dash pad

Dash pad for BMW R 850/1150R in a sporty carbon look - protects this very visible part of your bike from key scratches and enhances its appearance.

Scratch resistant, self adhesive pad.

(or Nr. 80060 for R850/1100R).

ArtNo.	Description	Price
80090	Dash pad R1150R	€ 7,80



Carbon Front mudguard

It is perfect customised for the R 850 R from 9/02 & R 1150 R (not Rockster). With its widening in the back it almost stops the water splashes.

Dirt and mud can't stay at the front fender because it has no footbridges.

Weight ca. 184 gram light but very solid. Including ABE.

ArtNo.	Description	Price
110220	Front mudguard (front part)	€ 219,90
110221	Front mudguard (rear part) Get rid of that ugly plastic!	€ 139,90



Carbon Rear Hugger

Provides ultimate protection for the rear shock absorber!

Spend less time cleaning and more time riding!

The best fit possible is provided by an aluminium fastener.

With ABE.

ArtNo.	Description	Price
110310	Rear Hugger	€ 219,90



You can find more suspension
for the R1150R online:
www.mhornig.com

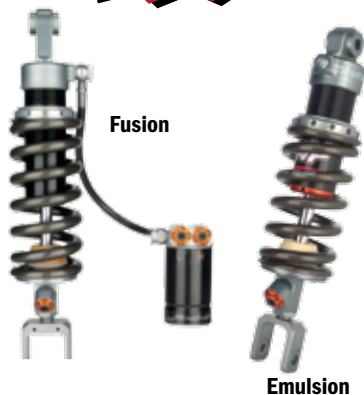

WP Suspension front & rear

Our WP suspensions will be specially adjusted for you! Because of this please inform us about your weight with clothes and helmet, the weight of your luggage (perhaps pillion rider), where you ride (street, off-road, race) and how you ride (sport, touring, and so on) in the „comment“ of your order.

You can choose any spring colour you like.
High/Low speed compression separately adjustable, each 16 times (256 possibilities) (only Spin and Fusion)
Suspension rear: adjustable rebound preload adjuster
Suspension front: preload adjuster, 16 positions

For riders wanting the upmost from their machine
Exceptional cooling properties due to the use of heat diverting aluminium alloys, therefore constant shock absorption and longer life
Lightweight through use of high quality materials
Adjustable length is standard
Recognised safety certificate
For BMW R850/1100R.

ArtNo.	Description	Price
17.06.P7.65	Spin suspension with fixed reservoir	€ 899,00
17.06.P9.65	Emulsion suspension front	€ 549,00
17.06.P8.67	Fusion suspension with reservoir fixed by a steel flex rear	€ 849,00
17.06.P9.67	Emulsion suspension rear	€ 549,00
/02	Hydraulic preload adjustment	€ 229,00



Aluminium

Remus Revolution

R 1150 R 99 model or newer
R 1150 R Rockster 03 model or newer
Perfect Looking, quick and easy Mounting, less Weight, more Power, more Torque, deep and throaty Sound combined with ABE (European Homologation) Real riding pleasure!

ArtNo.	Description	Price
For R1150R 99-* and R1150R Rockster 03-*		
078102 087799	Slip-on exhaust without catalytic, with EG/ABE, Aluminium	€ 709,00
078802 087799	Slip-on exhaust without catalytic, with EG/ABE, Titanium	€ 832,00
078702 087799	Slip-on exhaust without catalytic, with EG/ABE, black	€ 744,00
008102 087799	Slip-on, exhaust silencer, with EG/ABE, Aluminium	€ 390,00
008402 087799	Slip-on, exhaust silencer, with EG/ABE, Carbon	€ 513,00
008802 087799	Slip-on, incl. front exhaust silencer, with EG/ABE, Titanium	€ 513,00

You can find more exhausts from Laser, BOS and Sebring online: www.mhornig.com



How do you sit on your motorcycle seat? Do you want to change something in your seat?

Then read through the pages of the catalog **SEAT ALTERATION**.
We will change your seat exactly like you want it to be.

You need a Tank bag, Tear Seat Bag, Duffel Bag,
Inside Bag, Universal Bag or Tool Bag?
You can find it under **SOFT BAGS** in the catalog
and online: www.mhornig.com





SPIRIT & SPA
BIRKENHOF
 am Elfenhain

magisch.mystisch.menschlich...



In allen **BirkenhofReichen** wollen wir Ihnen Gutes tun – für Körper, Geist und Seele. Damit Sie auch nach dem Urlaub noch lange davon zehren können. Wir wollen Sie stets aufs Neue verzaubern – mit einer Prise Magie, mit einem Hauch Mystik und viiiel Menschlichkeit! Eben: magisch.mystisch.menschlich...



Pures Abtauchen 2 Übernachtungen mit allen Birkenhof-Inklusivleistungen ■ 1x Wohlfühlmassage ■ 1x Gesichtspackung mit Paraffinhandpackung ■ Teilnahme am täglich wechselnden Body- & MindFitnessprogramm ■ freie Nutzung unseres über 3.500 m² großen Wellnessbereichs mit weitläufiger Bade- & Saunalandschaft ■ **Bonus!** bei Anreise So/Mo/Di/Mi ist der WellnessstagPlus inklusive
Preis/Person von 257,- bis 365,- (Die Pauschale „Pures Abtauchen“ ist ganzjährig buchbar, ausg. Weihnachten/Neujahr, Anreise: täglich)

Dayspa: Ein Tag zum Wohlfühlen Day-Spa-Tagesarrangement, inklusive ■ kuscheliger Bademantel und Saunatücher für Ihren Wohlfühltag ■ Nutzung von Bade- & Saunalandschaft und Fitnessraum von 10.00 bis 23.00 Uhr ■ Nachmittagsbuffet (13.30-16.30 Uhr) im Restaurant „Gaumenzauber“ (Suppe, Salate, kalte/warme Leckereien, Obst- und Rohkostplatten, Kaffee & Kuchen, diverse alkoholfreie Getränke) ■ Wasser/Tees im Wellnessbereich ■ Individuelles Behandlungspaket mit Wellnessbehandlungen zur Wahl
Wählen Sie Ihr Arrangement: ■ „Tief-verwurzelte Ruhe“ (102,- p.P.) ■ „Wunderbarer Energiequell“ (127,- p.P.) ■ „Naturschönes Ganzes“ (154,- p.P.)
 Darf's noch ein bisschen mehr sein? ■ Beginnen Sie Ihren Genusstag am Frühstücksbuffet in unserem Restaurant (Aufpreis 12,- p.P.) ■ Genießen Sie als Abschluss ein perfektes kulinarisches Finish: Ein 5-Gänge-Menü (25,- p.P.) oder ein Candle-Light-Dinner (39,- p.P.)

Birkenhof verschenken

Es ist 5 vor 12 und Sie brauchen noch...
 ...den Birkenhof zum Verschenken!

Telefonisch (09941/4004-0) oder „24 Stunden täglich“
 in unserem Online-Shop: www.hotel-birkenhof.de

Wellnesspagode „SinnesReich“
 für individuelle Wellnessbehandlungen:
 Ayurveda-, Klang-, Wellness-Massagen,
 Körperbehandlungen im Türkischen Hamam
 oder in der Softpackliege, Kosmetik u.v.m.

unser sinnesreich
 ist wahrlich
 an sinnen reich.



R 850 - 1200 C & CL



R850/1200C

built from 1997 to 2001 / since 1997
848/1170 ccm cylinder capacity
power: 50/61 PS
max. torque 71/98 Nm

R1200CL

built since 2002
1170 ccm cylinder capacity
power: 61 PS
max. torque 98 Nm



Motorradzubehör

KORNIG

Upgrades for your bike

motorradzubehör kornig.de



Oil filler plug with emblem

There is a drilling in the side of the plug in which you can put a size 3 Allen key or a Torx key T10 (usually found in the your BMW toolkit) in order to fit and remove it.

ArtNo.	Description	Price
0040	polished	€ 24,80
0240	anodized	€ 24,90
0055	black anodized	€ 25,90
10011	O-ring	€ 1,20



Oil filler plug

This oil filler plug with Allen tool looks absolutely great because of its finish and has good function as a locking plug. Use a size 5 Allen key (usually found in the your BMW toolkit) in order to fit and remove.

ArtNo.	Description	Price
0030	polished	€ 19,80
0010	anodized	€ 19,90
0020	black anodized	€ 19,95
10011	O-ring	€ 1,20



Key holder with emblem

Useful key holder made of knurled aluminium, polished on top, with our emblem.

Just slot in the „Emergency key“ and fix with a setscrew. 0076 : Also possible to hook in a carabineer.

ArtNo.	Description	Price
0075	polished without eye	€ 19,70
0076	polished with eye	€ 28,50



Rear wheel hub cap

For spoke wheel made of aluminium natural anodized or polished: rear wheel hub cap with all parts needed to fit it Fits for R850/1200C.

[You can download how to install it online](#)

ArtNo.	Description	Price
0150	polished	€ 39,80
0250	anodized	€ 39,90

Rear wheel centre cover

A cover made of aluminium with emblem.
The mounting is quite easy: just put it into the hole of the wheel. Perfect fit is guaranteed by an o-ring.

There are different drillings in the 5-spoke aluminium wheel (please measure!).

ArtNo.	Description	Price
0-300-1	Size 32,3 anodized	€ 18,90
0-301-1	Size 30,5 anodized	€ 18,90
0-303-1	Size 31,8 anodized	€ 18,90
0-300-0	Size 32,3 polished	€ 18,80
0-301-0	Size 30,5 polished	€ 18,80
0-303-0	Size 31,8 polished	€ 18,80



Camshaft lid

Made of high quality aluminium and fits all four valve twins as a replacement for the original plastic cap.

The delivery occurs as a set of two caps with the o-rings and screws.

ArtNo.	Description	Price
0160	1 Set polished	€ 29,90
0360	1 Set anodized	€ 29,95
60010	S/S Round Head Screws (you need 4 screws)	€ 0,40



Telelever end caps

These telelever end caps add a new optical highlight on your BMW.

Nice form and robust material.

Always sold as a set in polished or anodized version.

ArtNo.	Description	Price
0090	1 Set polished	€ 26,70
0290	1 Set anodized	€ 26,90





Centre cap top yoke

Fits for R850/1200C & I. You can also use a BMW emblem. It is made of high-quality aluminium and polished. It is no visible difference between our polished and cromiumplated parts. The advantage of our polished products is their colour resistance. They won't change their polished look even after extreme atmospheric conditions. Another advantage of our polished parts is that no cromium can flake off. Because of this we improved our polished methods and did without cromiumplating.

ArtNo.	Description	Price
0085	high polished	€ 23,90



Toolbox

Toolbox for R 850/1200 C until 2003 model.

The polished pipe is made of stainless steel with two polished aluminium caps. It fills that void between the rear mudguard and the rear shock and provides a waterproof place for tools, maps or any other small items. It bolts to the rear mudguard bracket on the frame (screws included). The end cap unscrews and seals with an o-ring. Not for models with Suspension and Hydraulic preload adjustment

ArtNo.	Description	Price
0230	high polished	€ 129,90



Swing arm Pivot Cover right

This Swing arm Pivot Cover for the right side is a very nice replacement for the original. Made of high quality aluminium and polished.

Fit for R850/1200C.

ArtNo.	Description	Price
0348	high polished with emblem	€ 25,50
0348-1	high polished without emblem	€ 21,90



Swing arm Pivot Cover left

Swing arm pivot cover for the left side.

Fits for R850/1200C.

ArtNo.	Description	Price
0349	high polished with emblem	€ 25,60
0349-1	high polished without emblem	€ 22,90

Shift lever enlarger

It is nicely machined of aluminium and polished.

The special shape gives a very good grip. Just lube up the rubber with a bit of soapy water and slip it on. It will stay put.

Fits for R850/1200C & R1200CL bikes.

ArtNo.	Description	Price
0197	polished	€ 20,90
0397	polished with O-Rings for better grip and racing look	€ 22,90



Kickstand

For BMW R 850/1200 C, Montauk, Independent and CL. Perfectly suitable for removing the wheels. Saves tyres in winter. Very easy to store because of its removable bar end.



ArtNo.	Description	Price
cruiser07	Kickstand	€ 82,00



Chrome cap I

The chrome caps for the gear oil filler screw are an optical improvement for your BMW.

You simply push them on. The caps fit into the gear oil filler screw with Allen head and will fit any other screws with the same Allen size.

ArtNo.	Description	Price
0500	Big chrome caps	€ 4,25
0501	Small chrome caps	€ 3,75



Chrome cap II

Chrome cap II was created for covering the gear oil filler screw.

Like cap I it is just pushed on and fits perfectly.

ArtNo.	Description	Price
0502	Chrome cap II	€ 3,80



S/S screws

Brake fluid - & clutch reservoir

get a new look with these 4x S/S screws

70070: For all (elderly) Bikes with a hydraulic brake and no hydraulic clutch

70075: For all (newer) Bikes with a hydraulic brake and a hydraulic clutch

ArtNo.	Description	Price
70070	4 x M5x16	€ 3,95
70075	4 x M4x16	€ 3,95

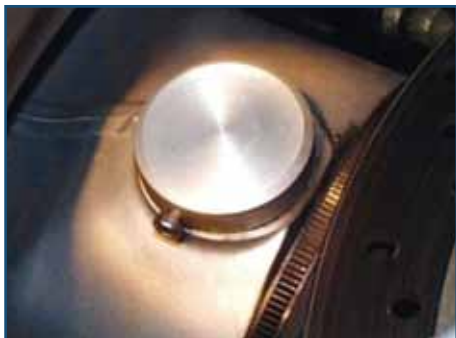

Paralever pivot cap

Effective prevention of dirt is guaranteed by this paralever pivot cap.

Highest quality and a perfect look anodized aluminium.

ArtNo.	Description	Price
0070	anodized	€ 12,90

Mirror Heightening

Our Mirror Heightening are the perfect solution when you see mainly your shoulders in the rear mirrors. The mirrors will be moved 2,5 centimeters higher and that creates the necessary space in order to improve the view to the back.
Fit for R1200C.

ArtNo.	Description	Price
BK 00	Mirror Heightening 1 Set	€ 19,90



Mirror-catch-cable

These cables are very easy to install and at the same time very effective. They protect the cables to the indicators and ensure that they wont break, even in an accident. You will save a lot of money as a new mirror for your bike isnt cheap.
Delivered as a set with fitting instructions.
Fit for R1200CL.

ArtNo.	Description	Price
0600	Mirror-catch-cable 1 Set	€ 7,95



GPS Mounting

Bolt + Ram-Ball

CNC machined for TomTom Rider 2 and Garmin Zumo.

You can mount all Ram-Mounts on the Ram-Ball.

RAM mount secured so that the NAVI longer comes to the centre of the handlebars. Otherwise, the mirror is covered. See: Art-No.: NH 3 / 1

Colour: Black

Fit for R1200CL.

ArtNo.	Description	Price
NH 1/5	GPS Mounting black	€ 24,95



GPS Mounting

Handlebar mounting for 24mm or 28mm handlebars + Ram-Ball with M10 x 1,25 thread;

CNC machined for TomTom Rider 2 and Garmin Zumo.

Ram-Ball mount may be used for many other items, too.

Colour: Chrome

Fit for R1200C und R1200CL.

ArtNo.	Description	Price
NH 1/3 c 24	GPS Mounting 24mm	€ 49,95
NH 1/3 c 28	GPS Mounting 28mm	€ 49,95



LED indicator panels

Fits for R850/1200C & Montauk.
Awesome brightness, fitted in seconds and including electronics on the back of the panel to ensure the correct flash rate.
The LEDs flash yellow. Sold in pairs.

ArtNo.	Description	Price
20101-01	1 Set LED indicator panels	€ 85,60
20101-02	1 Set LED indicator panels with red strip actuated by brake switch Not allowed in Germany	€ 88,00



Clear indicator lens

These clear indicator lenses give your BMW a quite sporty look.
Supplied as pairs but if you want, also as single items.
Amber bulbs included!

ArtNo.	Description	Price
L30103	1 Set Clear indicator lens	€ 18,95
L30103-g	1 Set Grey indicator lens	€ 18,95



LED chrome turning signal

Awesome brightness, fitted in seconds and including electronics on the back of the panel to ensure the correct flash rate. It is the complete turning signal and has a homologation. So it is the first road legal LED for BMW bike. The LEDs flash yellow. Sold in pairs.
Fits for R850/1200C/CL/I & Montauk.

ArtNo.	Description	Price
1047	1 pair with clear lenses	€ 99,95
1047-g	1 pair with grey lenses	€ 99,95



Indicator bulb

Either orange or special coating. The special coated one only lights orange when you use the indicator (usually used with transparent lenses). Single

ArtNo.	Description	Price
BLWB	orange 12V/21W	€ 2,45
BLWBT	special coated 12V/21W	€ 9,90

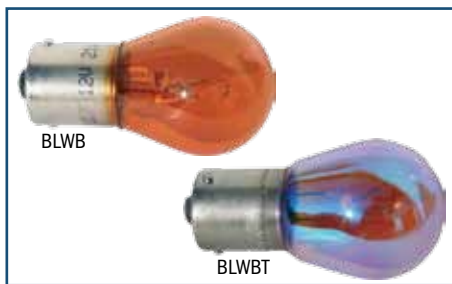



Image 1: Standard LED

Image 2: Clear lens with red bulb



Clear indicator lenses front + Bulbs

Amber bulbs included, sold in pairs! Fits for R1200CL.

ArtNo.	Description	Price
WLB-47	1 Set clear indicator lenses	€ 37,95
WLB-47-S	1 Set grey indicator lenses	€ 38,90

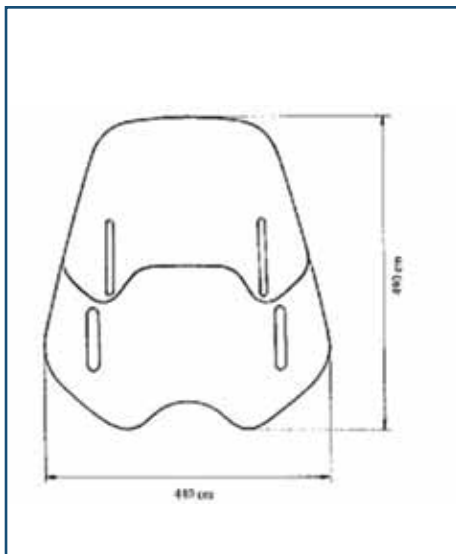

LED / clear lens

This LED gives your R 850 C, R 1200 C & Montauk and brand new look. It is a high quality LED rear and brake light and you can combine it with a clear lens. The LED is available in a standard and a design version. The light for the license plate stays original with a bulb.

ArtNo.	Description	Price
1 01 07 - 01	Standard LED	€ 82,95
1 01 07 - 02	Standard LED with Integral-Compensation	€ 92,30
Integral compensation for motorcycles with Integral ABS (applying the front brake, also brakes the rear wheel) These motorcycles have a display in the cockpit if a bulb is defective.		
1 01 07 - 03	Design LED	€ 79,90
3 01 07	Clear lens with red bulb	€ 46,95



Varioscreen

The windscreen Varioscreen is produced and tailored precisely. All screens are forwarded with the exact mounting (Handlebar mount). But screens and mountings are also available separately.

VarioScreen windscreens feature Two-piece construction with a two-point handlebar mount for Naked Bikes and Cruisers. The upper portion of the windscreen can be adjusted (+/- 2 inches) to various heights to suit the rider's taste and smooth out airflow.

ArtNo.	Description	Price
For R850/1200C - handle bar diameter 24mm		
VNB-boxer-k	Varioscreen clear	€ 169,90
VNB-boxer-rg	Varioscreen smoke grey	€ 169,90
For R850/1200C - handle bar diameter 28mm		
VNBr1200c-k	Varioscreen clear	€ 169,90
VNBr1200c-rg	Varioscreen smoke grey	€ 169,90

Roadshield

The windscreen Roadshield is produced and tailored precisely. All screens are forwarded with the exact mounting (Handlebar mount).

But screens and mountings are also available separately.

ArtNo.	Description	Price
For R850/1200C - handle bar diameter 24mm		
RO-boxer-k	Roadshield clear	€ 94,90
RO-boxer-rg	Roadshield smoke grey	€ 94,90
For R850/1200C - handle bar diameter 28mm		
ROR1200c-k	Roadshield clear	€ 94,90
ROR1200c-rg	Roadshield smoke grey	€ 94,90

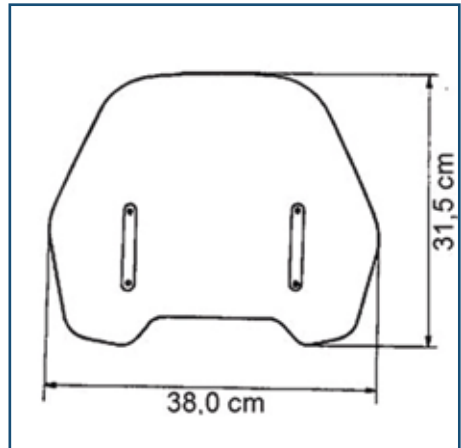

Highwayshield

The windscreen Highwayshield is produced and tailored precisely. All screens are forwarded with the exact mounting (Handlebar mount).

But screens and mountings are also available separately.

ArtNo.	Description	Price
For R850/1200C - handle bar diameter 24mm		
HI-boxer-k	Highwayshield clear	€ 109,90
HI-boxer-rg	Highwayshield smoke grey	€ 109,90
For R850/1200C - handle bar diameter 28mm		
Hlr1200c-k	Highwayshield clear	€ 109,90
Hlr1200c-rg	Highwayshield smoke grey	€ 109,90

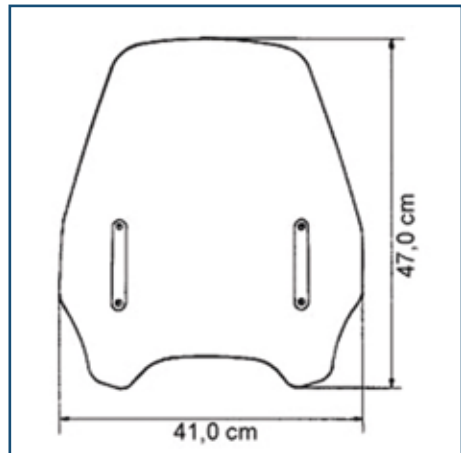

Customshield

The windscreen Customshield is produced and tailored precisely. All screens are forwarded with the exact mounting (Handlebar mount).

But screens and mountings are also available separately.

ArtNo.	Description	Price
For R850/1200C - handle bar diameter 24mm		
CU-boxer-k	Customshield clear	€ 109,90
CU-boxer-rg	Customshield smoke grey	€ 109,90
For R850/1200C - handle bar diameter 28mm		
CUR1200c-k	Customshield clear	€ 109,90
CUR1200c-rg	Customshield smoke grey	€ 109,90

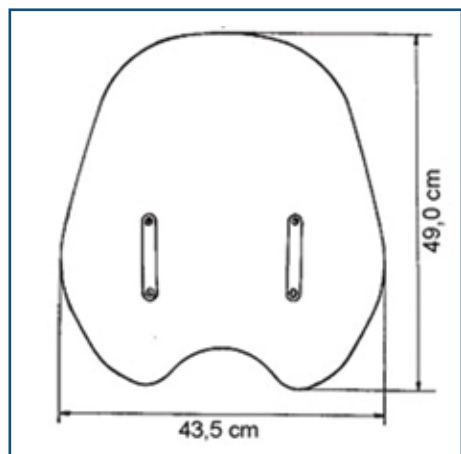



Carbon Rear Hugger

Provides ultimate protection for the rear shock absorber!
Spend less time cleaning and more time riding!
The best fit possible is provided by an aluminium fastener. With ABE.
Not for the BMW R1200CL.

ArtNo.	Description	Price
110310	Rear Hugger	€ 219,90



Carbon starter cover

This starter cover made of carbon fibre will surely become the latest highlight on your BMW.
It fits all GS-models.
Looks even better in combination with other carbon parts.

ArtNo.	Description	Price
110330	Starter cover	€ 179,00

You need a Tank bag, Tear Seat Bag, Duffel Bag,
Inside Bag, Universal Bag or Tool Bag?
You can find it under SOFT BAGS in the catalog
and online: www.mhornig.com



WP suspension front & rear

Our WP suspensions will be specially adjusted for you!

Because of this please inform us about your weight with clothes and helmet, the weight of your luggage (perhaps pillion rider), where you ride (street, off-road, race) and how you ride (sport, touring, and so on) in the „comment“ of your order.

You can choose any spring colour you like.

High/Low speed compression separately adjustable, each 16 times (256 possibilities) (only Spin and Fusion)

Suspension rear: adjustable rebound preload adjuster

Suspension front: preload adjuster, 16 positions

For riders wanting the upmost from their machine Exceptional cooling properties due to the use of heat diverting aluminium alloys, therefore constant shock absorption and longer life

Lightweight through use of high quality materials

Adjustable length is standard

Recognised safety certificate

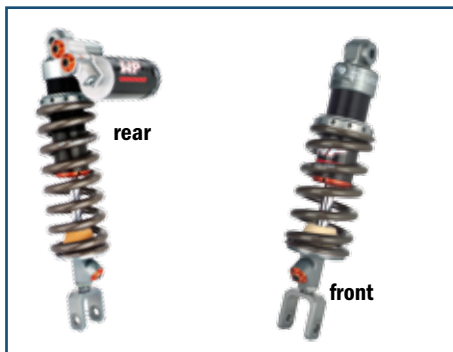

ArtNo.	Description	Price
17.06.S7.54	Spin suspension with fixed reservoir Only for model -2003	€ 899,00
17.06.S9.54	Emulsion suspension	€ 549,00
17.06.S9.55	Emulsion suspension front	€ 549,00

Change front and rear seat

The drivers and pillion rider s seat are equipped with a fluting in order to release the tail bone. The seats were also broadened for about 15mm. The padding consists of two layers, the upper one comfortably soft and the lower one avoids denting. We especially took care of the pillion rider s comfort: Here, the seat is increased in the middle front part to inhibit a cramped position. These alterations care for a tangible comfortable riding - free from pain. Also the vexatious sliding when the driver brakes has an end now. The seats are slippage related material.

Available in three heights

(please note in the comment with the article number):

- 1: like the original one
- 2: lower (- ca. 25mm)
- 3: higher (+ ca. 25mm)



ArtNo.	Description	Price
sitzF	Driver's seat black	€ 189,00
sitzS	Pillion's seat black	€ 184,00
s-g	Extra charge black-grey (for each seat)	€ 29,00



R1100/1150RT

built from 1995 to 2001 / since 2001

1085/1130 ccm cylinder capacity

power: 90/98 PS

max. torque 95/100 Nm



Fahrzeugaufbereitung und Smart-repair

- **Professionelle Fahrzeugaufbereitung**
- **Kleinschaden Instandsetzung**
- **Lackierarbeiten und Spot-Repair**
- **Polster- & Teppichreparatur**
- **Leder- & Vinylreparatur**
- **Dellenentfernung ohne lackieren**
- **Nano-Versiegelungen**
- **Autoglasarbeiten**
- **Sonnenschutzfolien**
- **Geruchsneutralisierung**

NEU!!! NANO-BESCHICHTUNG

Die Nanobeschichtung in unserem Hause ist eine 100%iges Nanoprodukt und wird im Lackierverfahren aufgetragen!

0151 - 24 16 14 25

09948 - 955 91 69

Hochwiesenweg 2 - 93458 Eschlkam / Ritzenried

www.carclean-schamberger.de

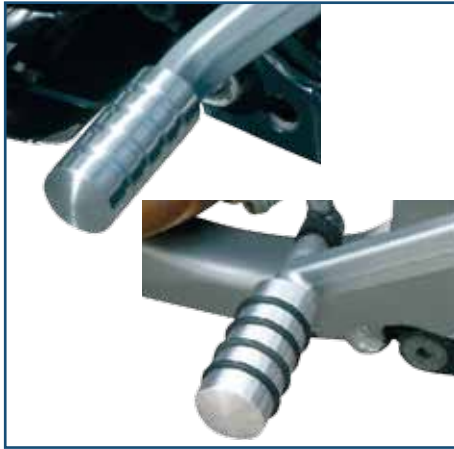

Shift lever extension

Many BMW riders think that their shift lever is a little too thin and doesn't give enough grip when they're shifting. This enlarger will solve this problem for you as it offers more grip and a more sporty look for your bike. Available in polished or anodized.

ArtNo.	Description	Price
0190	polished	€ 21,40
0390	anodized	€ 21,80
0195	polished with o-rings	€ 23,50
0395	anodized with o-rings	€ 23,90
19x3	O-Ring	€ 0,65



Key holder with emblem

Useful key holder made of knurled aluminium, polished on top, with our emblem. Just slot in the „Emergency key“ and fix with a setscrew. 0076 : Also possible to hook in a carabineer.

ArtNo.	Description	Price
0075	polished without eye	€ 19,70
0076	polished with eye	€ 28,50



Brake pedal enlargement

This brake pedal enlargement is nicely machined of aluminium, knurled and anodized. It is quite simple to install - just slip it on and lock in place with a set-screw.

ArtNo.	Description	Price
0100	Brake pedal enlargement	€ 24,40



Oil filler plug with emblem

There is a drilling in the side of the plug in which you can put a size 3 Allen key or a Torx key T10 (usually found in the your BMW toolkit) in order to fit and remove it.

ArtNo.	Description	Price
0040	polished	€ 24,80
0240	anodized	€ 24,90
0055	black anodized	€ 25,90
10011	O-ring	€ 1,20



Oil filler plug

This oil filler plug with Allen tool looks absolutely great because of its finish and has good function as a locking plug. Use a size 5 Allen key (usually found in the your BMW toolkit) in order to fit and remove.

ArtNo.	Description	Price
0030	polished	€ 19,80
0010	anodized	€ 19,90
0020	black anodized	€ 19,95
10011	O-ring	€ 1,20



Sidestand foot enlargement

Feel safer parking your bike on dirt or asphalt with a side stand foot enlargement.

More than 100% bigger contact area.

Made of high quality aluminium.

Black anodized. Easy to install.

ArtNo.	Description	Price
0709	Sidestand foot enlargement R1100RT	€ 23,40
0716	Sidestand foot enlargement R1150RT	€ 24,90



Stainless steel end weight

These end weights are made of Stainless steel and create a noble look for your bike. Included are two S/S-end weights and two S/S-countersunk screws M8 for fixing.

Fits for R850/1100/1150RT.

ArtNo.	Description	Price
0451	1 Set Stainless steel end weight	€ 30,95



Adjustable Foot pegs

The Vario Footrest System (Joint) will be mounted to the motorcycle like the original footpeg.

The adjustable Footrest system consists of 3 parts: Vario Joint, Vario Plate and the Footrest. All Items sold as a set for left and right.



Part 1

The Vario Footrest System (Joint) will be mounted to the motorcycle like the original footpeg. The Joint is silver anodized.

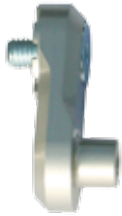

Part 2

The Vario Plate is the part between the Footpeg and the Vario Footrest System (Joint). The Vario Plate is available in 3 length. We recommend 50mm only for the pillion rider.



ArtNo.	Description	Price
For R1100RT MY 96-* and R1150RT 02-05		
051 02 01 00	Driver Vario Footrest System	€ 41,90
051 02 01 10	Pillion rider Vario Footrest System	€ 41,90
051 00 00 23	23mm Vario Plate	€ 44,50
051 00 00 30	30mm Vario Plate	€ 44,90
051 00 00 50	50mm Vario Plate (only pillion rider)	€ 45,90
050 00 08 00 8	Super Grip Footrest black	€ 51,80
050 00 04 00 1	Super Grip Footrest silver	€ 51,70
050 00 01 00 8	Racing Footrest black	€ 29,90
050 00 01 00 1	Racing Footrest silver	€ 29,95

Part 3

The Footpeg will be mounted to the Vario Plate. The Super Grip Footpegs are available in silver with black rubber.

The Racing Footpegs are available in black or silver. All Items sold as a set for left and right.



Short Paralever strut

This paralever (length 365mm) strut is made of high-quality steel and 20mm shorter than the original one. By what you can shorten the wheel base and that improves the handling of your bike eminent. The rear end of the bike will be a little higher as before.

ArtNo.	Description	Price
2314179	Short Paralever strut	€ 84,90

Centre cap top yoke

This part is an optical improvement for your top yoke as it is made of robust aluminium with an emblem.

An integrated o-ring ensures a snug fit.

ArtNo.	Description	Price
0060	polished	€ 24,60
0260	anodized	€ 24,90
0262	black anodized	€ 23,95
0065	polished (without emblem)	€ 18,95
0265	anodized (without emblem)	€ 18,95



Crashbars ZTechnik

ZTechnik's stainless steel Engine Guards will never rust like powder coated steel guards. They are carefully designed to allow clearance for oil changes or valve cover access, so they never need to be removed. Guards attach to the engine mounts not the engine covers to protect the engine heads and not destroy them. Integrated top brackets on each guard allow the rider to mount accessory lights, video cameras, or whatever they can imagine!

BMW R1100RT 94-00

BMW R1150RT 01-04



ArtNo.	Description	Price
Z7105	Crashbars ZTechnik	€ 299,00

Bar risers

This part will raise your handlebars 25mm, creating a more comfortable riding position, while enhancing the overall handling of your bike. Longer brake line not needed when installing these bar risers.

Set consisting of the bar risers and fitting screws.

Does not fit for bikes with switches on the handle bar!

ArtNo.	Description	Price
0420	1 Set anodized	€ 82,50
0425	1 Set polished	€ 82,60





Oil cooler protection

Very good protection for your oil cooler, at the same time a new highlight on your BMW. It is very precisely formed in order to stay in place without flutter. The front fairing has to be removed in order to install it. Installation manual included.

ArtNo.	Description	Price
0601	Oil cooler protection R1100RT	€ 25,90
0602	Oil cooler protection R1150RT	€ 26,90
s10ml	Silicone 10ml	€ 0,80



Speedometer trim

These polished rings for your speedometer and your rev counter are an optical improvement for your GS, RT or RS. Just stick on with glue or some silicone. May be removed without residue. Consists of a set of both rings.

ArtNo.	Description	Price
0400	1 Set polished	€ 39,90
0401	1 Set anodized	€ 42,90
s2ml	Silicone 2ml	€ 0,40



Screen attachment

This part is a replacement for the original plastic part. It is made of high quality polished or anodized aluminium and will be sent with the matching stainless steel screws. Not suitable for the V-Stream windshield.

ArtNo.	Description	Price
W.8161265.p	1 Set polished	€ 57,90
W.8161265	1 Set anodized	€ 59,90



Telelever end caps

These telelever end caps add a new optical highlight on your BMW.

Nice form and robust material.

Always sold as a set in polished or anodized version.

ArtNo.	Description	Price
0090	1 Set polished	€ 26,70
0290	1 Set anodized	€ 26,90

Camshaft lid

Made of high quality aluminium and fits all four valve twins as a replacement for the original plastic cap.

The delivery occurs as a set of two caps with the o-rings and screws.

ArtNo.	Description	Price
0160	1 Set polished	€ 29,90
0360	1 Set anodized	€ 29,95
60010	S/S Round Head Screws (you need 4 screws)	€ 0,40



Paralever pivot cap

Effective prevention of dirt is guaranteed by this paralever pivot cap.

Highest quality and a perfect look anodized aluminium.

ArtNo.	Description	Price
0070	anodized	€ 12,90



Hardware kit

Hardware kit consisting of 55 S/S screws. These stainless and polished screws look great and remain that way for years. Complete set with all screws needed and mounting guidelines.

ArtNo.	Description	Price
70010	Hardware kit R850/1100RT	€ 19,95
70020	Hardware kit R1150RT	€ 19,95
0421005	transp.Shim Ø 5,3mm	€ 0,14
0421006	transp.Shim Ø 6,4mm	€ 0,14



S/S screws

Brake fluid - & clutch reservoir

get a new look with these 4x S/S screws

70070: For all (elderly) Bikes with a hydraulic brake and no hydraulic clutch

70075: For all (newer) Bikes with a hydraulic brake and a hydraulic clutch

ArtNo.	Description	Price
70070	4 x M5x16	€ 3,95
70075	4 x M4x16	€ 3,95





Chrome cap I

The chrome caps for the gear oil filler screw are an optical improvement for your BMW.

You simply push them on. The caps fit into the gear oil filler screw with Allen head and will fit any other screws with the same Allen size.

ArtNo.	Description	Price
0500	Big chrome caps	€ 4,25
0501	Small chrome caps	€ 3,75



Chrome cap II

Chrome cap II was created for covering the gear oil filler screw.

Like cap I it is just pushed on and fits perfectly.

ArtNo.	Description	Price
0502	Chrome cap II	€ 3,80



Chrome cap III

The chrome cap III for the light adjustment will give your BMW another additional highlight.

The installation is as easy as effective - just stick it on with some glue like Uhu, or silicone.

ArtNo.	Description	Price
0505	Chrome cap III	€ 4,40
s2ml	Silicone 2ml	€ 0,40



Chrome cap IV

The chrome cap IV fits into the screw for the speedometer adjustment. This cap also - as the other chrome caps - makes your BMW more pleasing.

The mounting works the same way as with the other chrome caps.

ArtNo.	Description	Price
0507	Chrome cap IV	€ 4,05
s2ml	Silicone 2ml	€ 0,40

Mirror-catch-cable

These cables are very easy to install and at the same time very effective. They protect the cables to the indicators and ensure that they won't break, even in an accident. You will save a lot of money as a new mirror for your bike isn't cheap. Delivered as a set with fitting instructions. Fits for R1100/1150RT.



ArtNo.	Description	Price
0600	Mirror-catch-cable 1 Set	€ 7,95

Dash pad

Dash pad in carbon look - protects this very visible part of your bike from key scratches and enhances its appearance. Scratch resistant, self adhesive pad.



ArtNo.	Description	Price
80060	Dash pad	€ 6,80



GPS Mounting

Fast, easy mounting is possible with our new GPS Mount for BMW R1100, 1150RT. The windscreen can still be used in all positions and you always read your GPS without looking away from the street.

No vibrations!

For all BMW Navigators and Garmin SPIII, SP26**, 2720, Zumo 550, Zumo 660 and Nüvi series.

SP26** & 2720 owners need the Garmin Motorcycle Mount.

The TomTom Navigator can also be mounted with the correct adapter.



R1100RT



R1150RT

ArtNo.	Description	Price
44005	GPS Mounting R1100RT	€ 69,90
44006	GPS Mounting R1150RT	€ 79,90
tomtom-Ad	Adapter for TomTom Rider Incl. screws for mounting the GPS mount and the TomTom holder.	€ 9,55
tomt-Ad Ed 2	Adapter for TomTom 2nd Edition Incl. screws for mounting in the GPS mount and the TomTom holder.	€ 14,90
ram-1zoll	Adapter for 1" Ram-Ball	€ 29,90



Clear indicator lenses front + Bulbs

Amber bulbs included, sold in pairs!

Fits for BMW R1100/1150RT.

ArtNo.	Description	Price
WLB-47	1 Set clear indicator lenses	€ 37,95
WLB-47-S	1 Set grey indicator lenses	€ 38,90

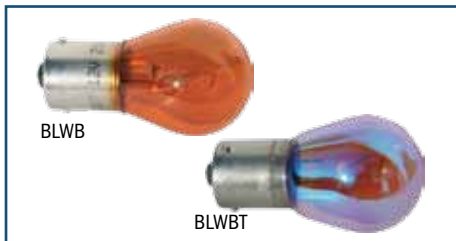

Indicator bulb

Either orange or special coating. The special coated one only lights orange when you use the indicator (usually used with transparent lenses). Single.

ArtNo.	Description	Price
BLWB	orange 12V/21W	€ 2,45
BLWBT	special coated 12V/21W	€ 9,90

Windscreen R1100RT

The „V-Stream“ Windshield set new standards for design, technology and comfort. Made of Quantum/Lexan Polycarbonate which is 10x more scratch-resistant than usual Acrylic. The windscreen will be shipped with everything you need to mount it.

Windshield V-Stream, clear, with homologation

ArtNo.	Description	Price
115113	Height 43cm, Width 55cm	€ 189,00
Z2458	Height 48cm, Width 56cm	€ 269,00
Z2459	Height 39cm, Width 53cm	€ 239,00



Windscreen R1150RT

The „V-Stream“ Windshield set new standards for design, technology and comfort. Made of Quantum/Lexan Polycarbonate which is 10x more scratch-resistant than usual Acrylic. The windscreen will be shipped with everything you need to mount it.

Windshield V-Stream, clear, with homologation

ArtNo.	Description	Price
115100	Height 43cm, Width 55cm	€ 189,00
Z2456	Height 48cm, Width 56cm	€ 269,00
Z2457	Height 38cm, Width 53cm	€ 239,00



Windscreen

This transparent wind screen with edge protection fits your R 1100, 1150 RT.

Size (H x W x T): 480mm x 508mm x 6mm

Height, measured from the bottom edge.

Installation as per original screen.

ArtNo.	Description	Price
D241ST	Windscreen	€ 119,90



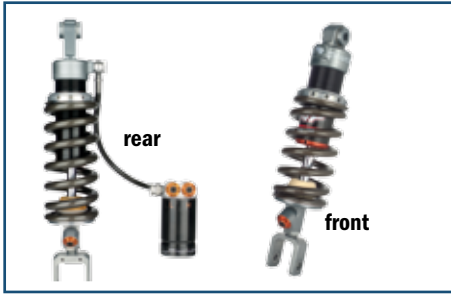

WP suspension front & rear

Our WP suspensions will be specially adjusted for you! Because of this please inform us about your weight with clothes and helmet, the weight of your luggage (perhaps pillion rider), where you ride (street, off-road, race) and how you ride (sport, touring, and so on) in the „comment“ of your order.

The Fusion as well as the Emulsion suspension can be combined with the hydraulic preload adjustment. (productnr. /02)

For extra charge you can choose any spring colour you like.

High/Low speed compression separately adjustable, each 16 times (256 possibilities) (only Spin and Fusion)

Suspension rear: adjustable rebound
preload adjuster

Suspension front: preload adjuster, 16 positions

For riders wanting the upmost from their machine
Exceptional cooling properties due to the use of heat diverting aluminium alloys, therefore constant shock absorption and longer life

Lightweight through use of high quality materials

Adjustable length is standard

Recognised safety certificate

For BMW R1100RT.

ArtNo.	Description	Price
17.06.P9.67	Emulsion suspension rear	€ 549,00
17.06.P8.67	Fusion suspension with reservoir fixed by a steel flex rear	€ 849,00
/02	Hydraulic preload adjustment	€ 229,00
17.06.P9.31	Emulsion suspension front	€ 549,00
17.06.P7.31	Spin suspension with fixed reservoir front	€ 899,00



Sebring Twister

R 1150 RT 99 model or newer Type R22/AV, 0419/A
52/70 kW

Slip-on incl. front exhaust silencer, Twister, with EG/ABE.
Choose the cover you like most! The exhaust is very easy to install and much lighter than the original one. But the most important argument is the deep and throaty sound combined with more power and more torque throughout the whole speed range. Real driving pleasure and of course with ABE (European Homologation)!

ArtNo.	Description	Price
TAT4001015	slip on, incl. VSD, without Cat., EG/ABE, Aluminium	€ 716,00
TCT4001015	slip on, incl. VSD, without Cat., EG/ABE, Carbon	€ 832,00
TTT4001015	Slip on, incl. VSD, without Cat., EG/ABE, Titanium	€ 832,00

You can find exhaust for the R1100RT
online: www.mhornig.com

Change front and rear seat

The drivers and pillion rider's seat are equipped with a fluting in order to release the tail bone. The seats were also broadened for about 15mm.

The padding consists of two layers, the upper one comfortably soft and the lower one avoids denting. We especially took care of the pillion rider's comfort:

Here, the seat is increased in the middle front part to inhibit a cramped position.

These alterations care for a tangible comfortable riding - free from pain. Also the vexatious sliding when the driver brakes has an end now.

The seats are slippage related material.

Available in three heights
(please note in the comment with the article number):

- 1: like your original one
- 2: lower (- ca. 25mm)
- 3: higher (+ ca. 25mm)

It's possible to change the seat with heater.
Your seat gets altered - you have to send it in!
The change takes about 2 weeks.



ArtNo.	Description	Price
sitzF	Driver's seat black	€ 189,00
sitzS	Pillion's seat black	€ 184,00
s-g	Extra charge black-grey (for each seat)	€ 29,00

You need a Tank bag, Tear Seat Bag, Duffel Bag,
Inside Bag, Universal Bag or Tool Bag?
You can find it under **SOFT BAGS** in the catalog
and online: www.mhornig.com



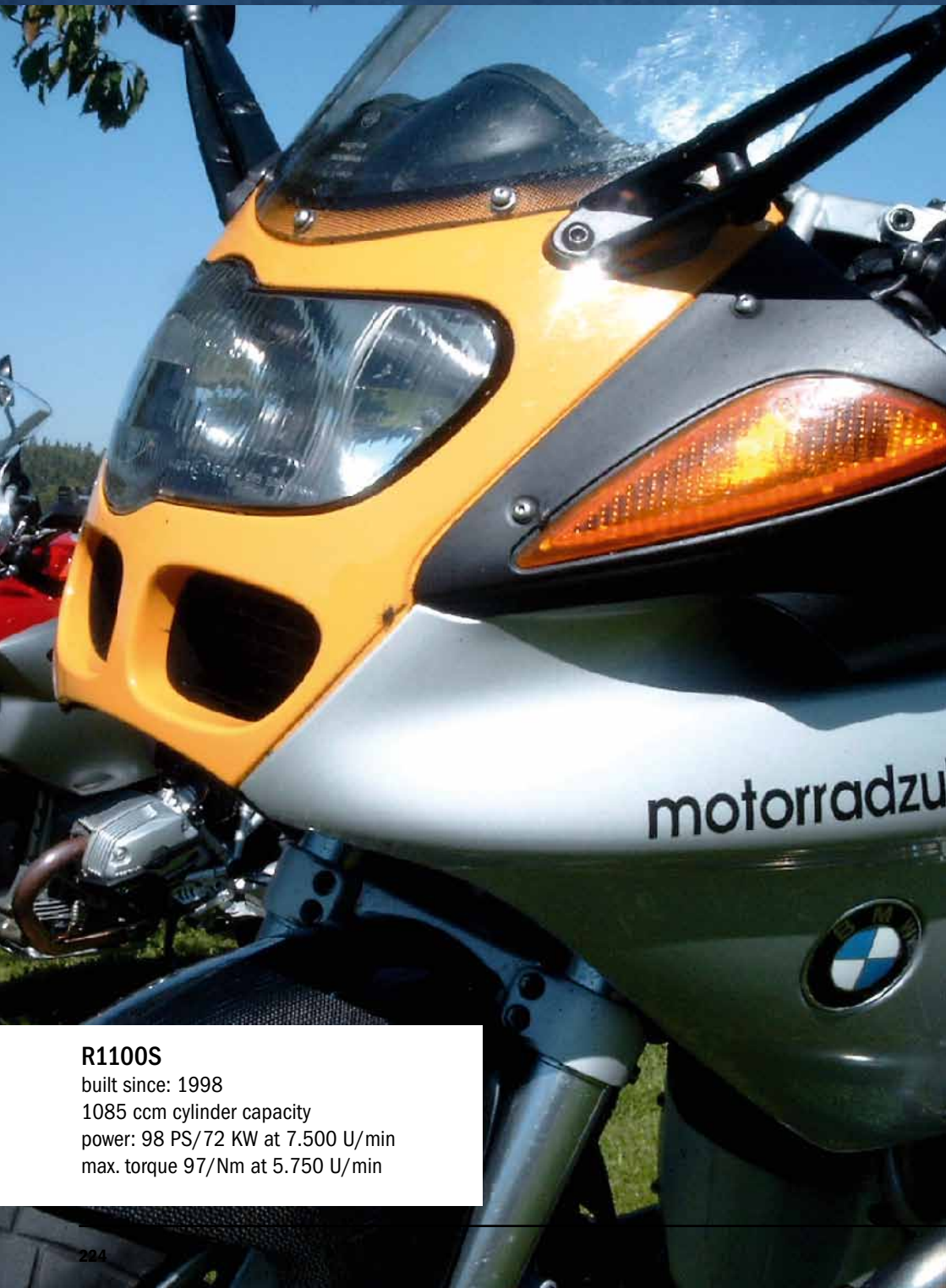

R1100S

built since: 1998

1085 ccm cylinder capacity

power: 98 PS/72 KW at 7.500 U/min

max. torque 97/Nm at 5.750 U/min

GPS Mounting

Bolt + Ram-Ball

CNC machined for TomTom Rider 2 and Garmin Zumo.

You can mount all Ram-Mounts on the Ram-Ball.

RAM mount secured so that the NAVI longer comes to the centre of the handlebars. Otherwise, the mirror is covered. See: Art-No.: NH 3/1

Colour: Black



ArtNo.	Description	Price
NH 1/5	GPS Mounting black	€ 24,95

GPS or Cam Mounting

Ram-Ball and mounting are CNC machined for TomTom Rider 2 and Garmin Zumo.

You can mount all Ram-Mounts on the Ram-Ball. If you want to install our GPS and Cam Mounting like you can see it on the other pictures you need just a longer screw.

The hole in our mounting is 10,5mm large.



ArtNo.	Description	Price
NH 1/8	GPS or Cam Mounting	€ 19,95

Shift lever extension

Many BMW riders think that their shift lever is a little too thin and doesn't give enough grip when they're shifting.

This enlarger will solve this problem for you as it offers more grip and a more sporty look for your bike. Available in polished or anodized.

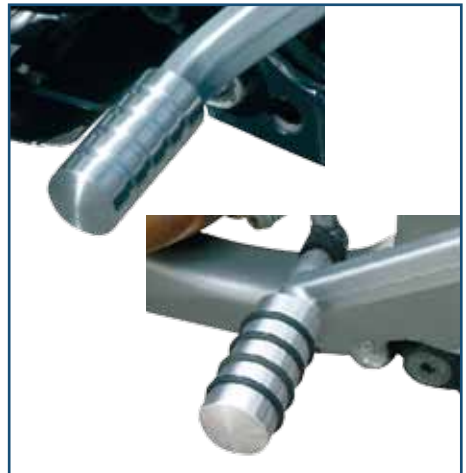

ArtNo.	Description	Price
0190	polished	€ 21,40
0390	anodized	€ 21,80
0195	polished with o-rings	€ 23,50
0395	anodized with o-rings	€ 23,90
19x3	O-Ring	€ 0,65



Number plate mounting

Our very light and shapely number plate mounting is made of aluminium and either black or natural coating. Incl. pre-assembled Number plate light, adapter plate, small, colour-coordinated LED turning signals and a reflector which can be left off.

Flash-Killer (you need 2 of them).

The power Resistance for Mini-indicators, realized an exact Power consumption to 21 watt.

ArtNo.	Description	Price
33003	Natural aluminium alloy	€ 259,80
33004	Black aluminium alloy	€ 259,80
123952	Flash-Killer	€ 12,95



Rear wheel centre cover

A cover made of aluminium with emblem.

The mounting is quite easy: just put it into the hole of the wheel. Perfect fit is guaranteed by an o-ring.

There are different drillings in the 5-spoke aluminium wheel (please measure!).

ArtNo.	Description	Price
0-300-1	Size 32,3 anodized	€ 18,90
0-301-1	Size 30,5 anodized	€ 18,90
0-303-1	Size 31,8 anodized	€ 18,90
0-300-0	Size 32,3 polished	€ 18,80
0-301-0	Size 30,5 polished	€ 18,80
0-303-0	Size 31,8 polished	€ 18,80

Short Paralever strut

This paralever (length 365mm) strut is made of high-quality steel and 20mm shorter than the original one. By what you can shorten the wheel base and that improves the handling of your bike eminent. The rear end of the bike will be a little higher as before.

ArtNo.	Description	Price
2314179	Short Paralever strut	€ 84,90



Camshaft lid

Made of high quality aluminium and fits all four valve twins as a replacement for the original plastic cap. The delivery occurs as a set of two caps with the o-rings and screws.

ArtNo.	Description	Price
0160	1 Set polished	€ 29,90
0360	1 Set anodized	€ 29,95
60010	S/S Round Head Screws (you need 4 screws)	€ 0,40



Telelever end caps

These telelever end caps add a new optical highlight on your BMW. Nice form and robust material. Always sold as a set in polished or anodized version.

ArtNo.	Description	Price
0090	1 Set polished	€ 26,70
0290	1 Set anodized	€ 26,90



Key holder with emblem

Useful key holder made of knurled aluminium, polished on top, with our emblem. Just slot in the „Emergency key“ and fix with a setscrew. 0076 : Also possible to hook in a carabiner.

ArtNo.	Description	Price
0075	polished without eye	€ 19,70
0076	polished with eye	€ 28,50





Brake pedal enlargement

Nicely machined aluminium, knurled and natural anodized.

This enlargement simply slips on and is held in place with a set-screw.

ArtNo.	Description	Price
0180	anodized	€ 22,15



Oil filler plug with emblem

There is a drilling in the side of the plug in which you can put a size 3 Allen key or a Torx key T10 (usually found in your BMW toolkit) in order to fit and remove it.

ArtNo.	Description	Price
0040	polished	€ 24,80
0240	anodized	€ 24,90
0055	black anodized	€ 25,90
10011	O-ring	€ 1,20



Oil filler plug

This oil filler plug with Allen tool looks absolutely great because of its finish and has good function as a locking plug. Use a size 5 Allen key (usually found in your BMW toolkit) in order to fit and remove.

ArtNo.	Description	Price
0030	polished	€ 19,80
0010	anodized	€ 19,90
0020	black anodized	€ 19,95
10011	O-ring	€ 1,20



Stainless steel end weight

These end weights are made of Stainless steel and create a more noble look for your bike and less vibration. Included in delivery are two S/S end weights and two S/S countersunk screws for fixing.

ArtNo.	Description	Price
05382	Stainless steel end weight	€ 34,95

Adjustable Foot pegs

The Vario Footrest System (Joint) will be mounted to the motorcycle like the original footpeg.

The adjustable Footrest system consists of 3 parts: Vario Joint, Vario Plate and the Footrest. All Items sold as a set for left and right.



Part 1

The Vario Footrest System (Joint) will be mounted to the motorcycle like the original footpeg. The Joint is silver anodized.



Part 2

The Vario Plate is the part between the Footpeg and the Vario Footrest System (Joint). The Vario Plate is available in 3 length. We recommend 50mm only for the pillion rider.



ArtNo.	Description	Price
051 02 02 00	Driver Vario Footrest System	€ 41,90
051 02 02 10	Pillion rider Vario Footrest System	€ 41,90
051 00 00 23	23mm Vario Plate	€ 44,50
051 00 00 30	30mm Vario Plate	€ 44,90
051 00 00 50	50mm Vario Plate (only pillion rider)	€ 45,90
050 00 04 00 8	Super Grip Footrest black	€ 51,80
050 00 04 00 1	Super Grip Footrest silver	€ 51,70
050 00 01 00 8	Racing Footrest black	€ 29,90
050 00 01 00 1	Racing Footrest silver	€ 29,95

Part 3

The Footpeg will be mounted to the Vario Plate. The Super Grip Footpegs are available in silver with black rubber.

The Racing Footpegs are available in black or silver. All Items sold as a set for left and right.

S-Lifter

Our front lifter fits for BMW R1100S. Only useable without an engine spoiler. It is perfect for care, overwinter, change wheels and servicing.

Made of steel, zinc-plated and quality „Made in Germany“.

The BoxerCup-Lifter is made for the BMW R1100S Boxer-Cup Replica and can be used with the engine spoiler.

ArtNo.	Description	Price
BSL	S-Lifter	€ 75,90
BSL011	BoxerCup-Lifter	€ 129,90





Mirror Extensions

Our Mirror Extensions are the perfect solutions if you see mainly your shoulders in the mirrors. The mirrors will be moved a few centimetres out in order to improve the view to the rear. Not with Superbike handlebars.

ArtNo.	Description	Price
BK 04	Mirror Extensions 1 Set	€ 49,95



Oil cooler screens

These stainless steel screens protect the oil cooler from stones, flies and other debris.

They are very easy to install and give your R1100S an even more sporty appearance.

ArtNo.	Description	Price
0605	anodized	€ 19,90
0605-s	black anodized	€ 23,90



Paralever pivot cap

Effective prevention of dirt is guaranteed by this paralever pivot cap.

Highest quality and a perfect look anodized aluminium.

ArtNo.	Description	Price
0070	anodized	€ 12,90



S/S screws

Brake fluid - & clutch reservoir

get a new look with these 4x S/S screws

70070: For all (elderly) Bikes with a hydraulic brake and no hydraulic clutch

70075: For all (newer) Bikes with a hydraulic brake and a hydraulic clutch

ArtNo.	Description	Price
70070	4 x M5x16	€ 3,95
70075	4 x M4x16	€ 3,95



Chrome cap I

The chrome caps for the gear oil filler screw are an optical improvement for your BMW.

You simply push them on. The caps fit into the gear oil filler screw with Allen head and will fit any other screws with the same Allen size.

ArtNo.	Description	Price
0500	Big chrome caps	€ 4,25
0501	Small chrome caps	€ 3,75



Chrome cap II

Chrome cap II was created for covering the gear oil filler screw.

Like cap I it is just pushed on and fits perfectly.

ArtNo.	Description	Price
0502	Chrome cap II	€ 3,80



Chrome cap V

The chrome cap V for the speedometer adjustment is an optical improvement for your BMW.

You simply stick it on e.g. with Uhu or Silicon.

If you have no silicone at home you can also order our high quality silicone which is pre-filled in the volume you need and easy to dose.

ArtNo.	Description	Price
0508	Chrome cap V	€ 1,70
s2ml	Silicone 2ml	€ 0,40



Hardware kit

The original black screws on your motorcycle fairing lose a little bit of crispness each time they are screwed in or out.

These stainless and polished screws look great and remain that way for years.

This is the complete kit for all screws, with mounting instruction, for all R1100S.

ArtNo.	Description	Price
70030	R1100S	€ 16,50
0421005	transp.Shim Ø 5,3mm	€ 0,14
0421006	transp.Shim Ø 6,4mm	€ 0,14



Crashbars ZTechnik

ZTechnik's stainless steel Engine Guards will never rust like powder coated steel guards. They are carefully designed to allow clearance for oil changes or valve cover access, so they never need to be removed. Guards attach to the engine mounts not the engine covers to protect the engine heads and not destroy them. Integrated top brackets on each guard allow the rider to mount accessory lights, video cameras, or whatever they can imagine!
BMW R1100S 98-05



ArtNo.	Description	Price
Z7105	Crashbars ZTechnik	€ 299,00



Clear indicator lens front

Clear indicator lens for the R1100S with special orange coated bulbs. Sold as singles.

ArtNo.	Description	Price
7658967	for the left side	€ 49,90
7658968	for the right side	€ 49,90

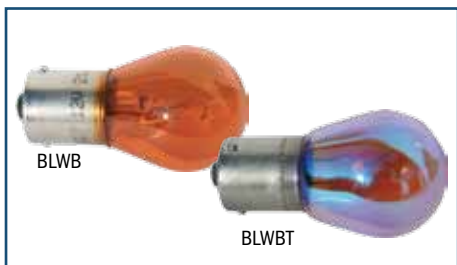

Indicator bulb

Either orange or special coating. The special coated one only lights orange when you use the indicator (usually used with transparent lenses). Single.

ArtNo.	Description	Price
BLWB	orange 12V/21W	€ 2,45
BLWBT	special coated 12V/21W	€ 9,90

LED turning signal

Awesome brightness, fitted in seconds and including electronics on the back of the panel to ensure the correct flash rate.

It is the complete turning signal and has a homologation.

So it is the first road legal LED for BMW bikes!

The LEDs flash yellow. Sold in pairs.

ArtNo.	Description	Price
0917	1 pair with clear lenses	€ 99,95
0917-g	1 pair with grey lenses	€ 99,95



Clear indicator lens rear

These clear indicator lenses give your BMW a quite sporty look.

Supplied as pairs but if you want, also as single items.

Amber bulbs included!

ArtNo.	Description	Price
L30103	1 Set Clear indicator lens	€ 18,95
L30103-g	1 Set Grey indicator lens	€ 18,95



LED tail light panel

Far brighter than the standard set up!

Fitted in seconds by anyone.

Features up to 24 red high intensity LEDs and (if necessary) 4 white ones for the number plate.

Will suit models with or without ABS fitted.

ArtNo.	Description	Price
10102-01	without Integral ABS	€ 82,90
10102-02	with Integral ABS	€ 96,50



LED Taillight

Complete Taillight with integrated LED-board for simply exchange! Road legal.

For bikes with and without ABS (Int. ABS).

ArtNo.	Description	Price
WLL-53-L	LED Taillight	€ 89,90
WL-53	Taillight lens (only lens)	€ 53,90





Carbon Rear Hugger

Provides ultimate carbon protection for the rear shock absorber. The best fit possible is provided by an aluminium fastener.
Spend less time cleaning - more time riding!
With ABE.

ArtNo.	Description	Price
010.10.12	Rear Hugger	€ 219,00



Carbon Front mudguard

Front mudguard carbon (front & rear part) Made of pure carbon fibre! Completely out of carbon fibre unlike the original one!

ArtNo.	Description	Price
110050	Front mudguard	€ 229,90



Carbon turn signal housing

Extremely light material although more robust than the original part.
One set consists of two housings.

ArtNo.	Description	Price
110090	Turn signal housing 1 Set	€ 359,80



Carbon starter cover

This starter cover made of carbon fibre will surely become the latest highlight on your BMW. It fits all GS-models. Looks even better in combination with other carbon parts.

ArtNo.	Description	Price
110330	Starter cover	€ 179,00



Dash pad

Dash pad in carbon fibre look - protects this very visible part of your bike from your key scratches. Scratch resistant, self adhesive pad.

ArtNo.	Description	Price
80081	Dash pad big	€ 12,90
80080	Dash pad small	€ 6,60



Spoiler screen

The Spoiler Screen is a flat, sport-styled windshield with a deep recess in the centre and a small spoiler in the centre. High=330mm

ArtNo.	Description	Price
S-r1100s-rg	smoke grey	€ 79,90
S-r1100s-k	clear	€ 79,90



Touring screen

Similar in shape to the original windscreen, the Touring Screen includes a raised extension approximately 2-3 inches (5-7 cm) taller than the original windscreen. High=390mm

ArtNo.	Description	Price
T-r1100s-rg	smoke grey	€ 79,90
T-r1100s-k	clear	€ 79,90



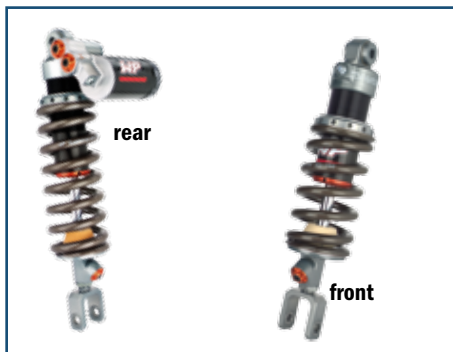

WP suspension front & rear

Our WP suspensions will be specially adjusted for you! Because of this please inform us about your weight with clothes and helmet, the weight of your luggage (perhaps pillion rider), where you ride (street, off-road, race) and how you ride (sport, touring, and so on) in the „comment“ of your order.

The Spin as well as the Emulsion suspension can be combined with the hydraulic preload adjustment. (productnr. /02)

You can choose any spring colour you like.

High/Low speed compression separately adjustable, each 16 times (256 possibilities) (only Spin and Fusion)

Suspension rear: adjustable rebound
preload adjuster

Suspension front: preload adjuster, 16 positions.

For riders wanting the utmost from their machine

Exceptional cooling properties due to the use of heat diverting aluminium alloys, therefore constant shock absorption and longer life

Lightweight through use of high quality materials

Adjustable length is standard

Recognised safety certificate

For BMW R1100S 99-05

BMW R1100S BoxerCup Replica 03-

ArtNo.	Description	Price
17.06.T7.33 (17.06.X7.80)	Spin suspension with fixed reservoir rear	€ 899,00
17.06.T9.33 (17.06.X9.80)	Emulsion suspension rear	€ 549,00
/02	Hydraulic preload adjustment	€ 229,00
17.06.T7.34 (17.06.X7.81)	Spin suspension with fixed reservoir front	€ 899,00
17.06.T9.34 (17.06.X9.81)	Emulsion suspension front	€ 549,00

Laser

Slip-on, with EG-ABE made of Stainless steel
The exhaust is very easy to install and much lighter than the original one. But the most important argument is the deep and throaty sound combined with more power and more torque throughout the whole speed range. Real driving pleasure and of course with ABE (European Homologation)!

The Tuning Chip Motronic is exactly synchronised to the Laser exhaust system.



ArtNo.	Description	Price
96.7001	Slip-on exhaust, stainless steel	€ 699,00
87.7006.Y	Tuning Chip for Motronic R 1100 S 09/00 - 02 model	€ 289,00
87.7010.Y	Tuning Chip for Motronic R 1100 S 03 model or newer	€ 289,00
96.7002	Connection pipe without catalytic converter with Lambda connection	€ 339,00



How do you sit on your motorcycle seat? Do you want to change something in your seat?

Then read through the pages of the catalog **SEAT ALTERATION**.
We will change your seat exactly like you want it to be.

You need a Tank bag, Tear Seat Bag, Duffel Bag,
Inside Bag, Universal Bag or Tool Bag?
You can find it under **SOFT BAGS** in the catalog
and online: www.mhornig.com



R1100RS

built from 1993 to 2001
1085 ccm cylinder capacity
power: 90 PS
max. torque 95 Nm

R1500RS

built from 2001 to 2004
1130 ccm cylinder capacity
power: 95 PS
max. torque 100 Nm

Camshaft lid

Made of high quality aluminium and fits all four valve twins as a replacement for the original plastic cap.

The delivery occurs as a set of two caps with the o-rings and screws.

ArtNo.	Description	Price
0160	1 Set polished	€ 29,90
0360	1 Set anodized	€ 29,95
60010	S/S Round Head Screws (you need 4 screws)	€ 0,40



Telelever end caps

These telelever end caps add a new optical highlight on your BMW.

Nice form and robust material.

Always sold as a set in polished or anodized version.

ArtNo.	Description	Price
0090	1 Set polished	€ 26,70
0290	1 Set anodized	€ 26,90



Short Paralever strut

This paralever (length 365mm) strut is made of high-quality steel and 20mm shorter than the original one. By what you can shorten the wheel base and that improves the handling of your bike eminent. The rear end of the bike will be a little higher as before.

ArtNo.	Description	Price
2314179	Short Paralever strut	€ 84,90



Key holder with emblem

Useful key holder made of knurled aluminium, polished on top, with our emblem.

Just slot in the „Emergency key“ and fix with a setscrew.

0076 : Also possible to hook in a carabineer.

ArtNo.	Description	Price
0075	polished without eye	€ 19,90
0076	polished with eye	€ 28,50





Speedometer trim

These polished rings for your speedometer and your rev counter are an optical improvement for your GS, RT or RS. Just stick on with glue or some silicone. May be removed without residue. Consists of a set of both rings.

ArtNo.	Description	Price
0400	1 Set polished	€ 39,90
0401	1 Set anodized	€ 42,90
s2ml	Silicone 2ml	€ 0,40



Centre cap top yoke

This part is an optical improvement for your bar risers as it is made of aluminium, furnished with a emblem. An integrated o-ring ensures a snug fit.

ArtNo.	Description	Price
0080	polished	€ 21,80
0280	anodized	€ 21,80



Brake pedal enlargement

This brake pedal enlargement is nicely machined of aluminium, knurled and anodized. It is quite simple to install - just slip it on and lock in place with a set-screw.

Fit for R1100RS.

ArtNo.	Description	Price
0100	Brake pedal enlargement	€ 24,60



Brake pedal enlargement

Nicely machined aluminium, knurled and natural anodized.

This enlargement simply slips on and is held in place with a set-screw.

Fit for BMW R1150RS.

ArtNo.	Description	Price
0180	anodized	€ 22,15

Adjustable Foot pegs

The Vario Footrest System (Joint) will be mounted to the motorcycle like the original footpeg.

The adjustable Footrest system consists of 3 parts: Vario Joint, Vario Plate and the Footrest.
All Items sold as a set for left and right.



Part 1

The Vario Footrest System (Joint) will be mounted to the motorcycle like the original footpeg. The Joint is silver anodized.



Part 2

The Vario Plate is the part between the Footpeg and the Vario Footrest System (Joint). The Vario Plate is available in 3 length. We recommend 50mm only for the pillion rider.



Part 3

The Footpeg will be mounted to the Vario Plate.

The Super Grip Footpegs are available in silver with black rubber.

The Racing Footpegs are available in black or silver.
All Items sold as a set for left and right.

ArtNo.	Description	Price
For R1100RS MY 92-*		
051 02 01 00	Driver Vario Footrest System	€ 41,90
051 02 01 10	Pillion rider Vario Footrest System	€ 41,90
For R1150RS MY 04-*		
051 02 02 00	Driver Vario Footrest System	€ 41,90
051 02 02 10	Pillion rider Vario Footrest System	€ 41,90
Vario Plate and Footrest for all models		
051 00 00 23	23mm Vario Plate	€ 44,50
051 00 00 30	30mm Vario Plate	€ 44,90
051 00 00 50	50mm Vario Plate (only pillion rider)	€ 45,90
050 00 04 00 8	Super Grip Footrest black	e 51,80
050 00 04 00 1	Super Grip Footrest silver	€ 51,70
050 00 01 00 8	Racing Footrest black	€ 29,90
050 00 01 00 1	Racing Footrest silver	€ 29,95





Oil filler plug with emblem

There is a drilling in the side of the plug in which you can put a size 3 Allen key or a Torx key T10 (usually found in the your BMW toolkit) in order to fit and remove it.

ArtNo.	Description	Price
0040	polished	€ 24,80
0240	anodized	€ 24,90
0055	black anodized	€ 25,90
10011	O-ring	€ 1,20



Oil filler plug

This oil filler plug with Allen tool looks absolutely great because of its finish and has good function as a locking plug. Use a size 5 Allen key (usually found in the your BMW toolkit) in order to fit and remove.

ArtNo.	Description	Price
0030	polished	€ 19,80
0010	anodized	€ 19,90
0020	black anodized	€ 19,95
10011	O-ring	€ 1,20

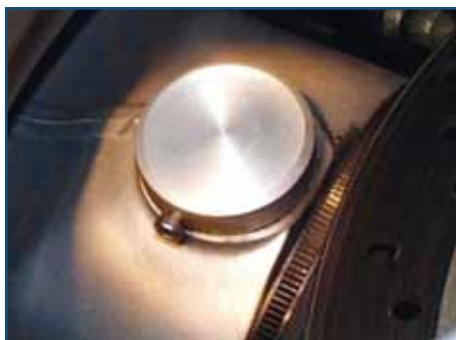

Paralever pivot cap

Effective prevention of dirt is guaranteed by this paralever pivot cap.

Highest quality and a perfect look anodized aluminium.

ArtNo.	Description	Price
0070	anodized	€ 12,90



Sidestand foot enlargement

Feel safer parking your bike on dirt or asphalt with a sidestand foot enlargement.

More than 100% bigger contact area.

Made of high quality aluminium.

Black anodized.

Easy to install.

Fits R1100RS.

ArtNo.	Description	Price
0709	Sidestand foot enlargement	€ 23,40

Shift lever extension

Many BMW riders think that their shift lever is a little too thin and doesn't give enough grip when they're shifting.

This enlarger will solve this problem for you as it offers more grip and a more sporty look for your bike. Available in polished or anodized.

ArtNo.	Description	Price
0190	polished	€ 21,40
0390	anodized	€ 21,80
0195	polished with o-rings	€ 23,50
0395	anodized with o-rings	€ 23,90
19x3	O-ring	€ 0,65

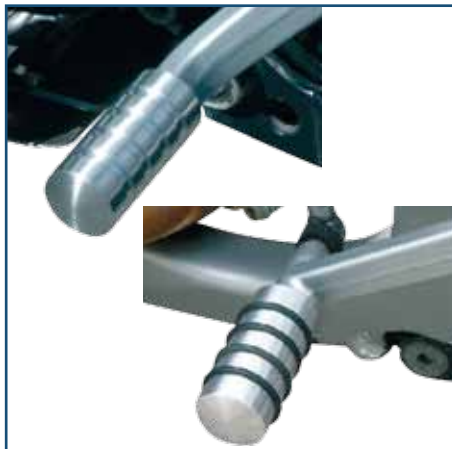

Mirror Heightening

Our Mirror Heightening are the perfect solution when you see mainly your shoulders in the rear mirrors. The mirrors will be moved 2,5 centimeters higher (R1150RS) and 3 centimeters higher (R1100RS) and that creates the necessary space in order to improve the view to the back.

ArtNo.	Description	Price
BK 00	Mirror Heightening R1150RS	€ 19,90
BK 00lr	Mirror Heightening R1100RS	€ 19,90



Rear wheel centre cover

A cover made of aluminium with emblem. The mounting is quite easy: just put it into the hole of the wheel. Perfect fit is guaranteed by an o-ring.

There are different drillings in the 5-spoke aluminium wheel (please measure!).

ArtNo.	Description	Price
0-300-1	Size 32,3 anodized	€ 18,90
0-301-1	Size 30,5 anodized	€ 18,90
0-303-1	Size 31,8 anodized	€ 18,90
0-300-0	Size 32,3 polished	€ 18,80
0-301-0	Size 30,5 polished	€ 18,80
0-303-0	Size 31,8 polished	€ 18,80





Chrome cap I

The chrome caps for the gear oil filler screw are an optical improvement for your BMW.

You simply push them on. The caps fit into the gear oil filler screw with Allen head and will fit any other screws with the same Allen size.

ArtNo.	Description	Price
0500	Big chrome caps	€ 4,25
0501	Small chrome caps	€ 3,75



Chrome cap II

Chrome cap II was created for covering the gear oil filler screw.

Like cap I it is just pushed on and fits perfectly.

ArtNo.	Description	Price
0502	Chrome cap II	€ 3,80



S/S screws

Brake fluid - & clutch reservoir

get a new look with these 4x S/S screws

70070: For all (elderly) Bikes with a hydraulic brake and no hydraulic clutch

70075: For all (newer) Bikes with a hydraulic brake and a hydraulic clutch

ArtNo.	Description	Price
70070	4 x M5x16	€ 3,95
70075	4 x M4x16	€ 3,95

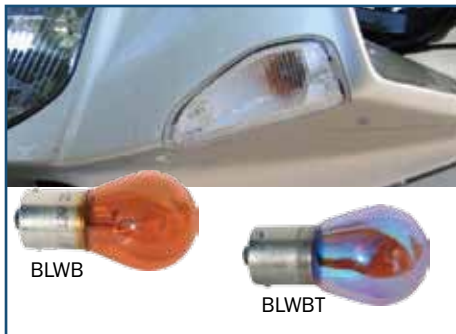

Clear lenses front

E-homologated! Sold in pairs, amber bulbs included!

Clear lenses fits BMW R1100RS, since 1992 and all R1150RS.

Indicator bulb in orange or special coating. The special coated one only lights orange when you use the indicator. Single.

ArtNo.	Description	Price
WLB-8144003	1 Set Clear lenses front	€ 26,90
BLWB	orange 12V/21W	€ 2,45
BLWBT	special coated 12V/21W	€ 9,90

Touring screen

The Touring screen has the same shape as the original one, but with an additional raised wind deflector about 5-7 cm high at the rear, across the entire width.

This deflects the wind over the rider and facilitates a relaxed drive, particularly on longer trips.

Fits the R1100RS.

ArtNo.	Description	Price
T-r1100rs-rg	smoke grey	€ 79,90
T-r1100rs-k	clear	€ 79,90



Dash pad

Dash pad in the carbon fibre look - protects this very visible part of your bike from your key scratches and enhances its appearance. Scratch resistant, self adhesive pad.

Available in two versions:

- pad 1 for use with original centre cap
- pad 2 for use with our top yoke centre cap.

ArtNo.	Description	Price
80085	Dash pad 1	€ 12,30
80086	Dash pad 2	€ 10,30



Crashbars ZTechnik

ZTechnik's stainless steel Engine Guards will never rust like powder coated steel guards. They are carefully designed to allow clearance for oil changes or valve cover access, so they never need to be removed. Guards attach to the engine mounts not the engine covers to protect the engine heads and not destroy them. Integrated top brackets on each guard allow the rider to mount accessory

lights, video cameras, or whatever they can imagine!
BMW R1100RS 93-00
BMW R1150RS 01-04



ArtNo.	Description	Price
Z7105	Crashbars ZTechnik	€ 299,00



Sebring Twister

R 1150 RS 99 model or newer Type R22/AV, 0419/A 52/70 kW

Slip-on incl. front exhaust silencer, Twister, with EG/ABE 2 versions with 3 covers each

This homologated (ABE) Exhaust offers not only a perfect Look with less Weight but also more Power and more Torque exactly where you need it combined with a deep and throaty Sound. Pure Driving Pleasure!

You can find more exhausts and suspensions for the R1100RS online: www.mhornig.com

ArtNo.	Description	Price
TAT4001015	slip on, incl. VSD, without Cat., EG/ABE, Aluminium	€ 716,00
TCT4001015	slip on, incl. VSD, without Cat., EG/ABE, Carbon	€ 832,00
TTT4001015	Slip on, incl. VSD, without Cat., EG/ABE, Titanium	€ 832,00



**How do you sit on your motorcycle seat?
Do you want to change something?**

Then read through the pages of the catalog

SEAT ALTERATION.

We will change your seat exactly like you want it to be.

You need a Tank bag, Tear Seat Bag, Duffel Bag, Inside Bag, Universal Bag or Tool Bag? You can find it under **SOFT BAGS** in the catalog and online: www.mhornig.com

WP suspension front & rear

Our WP suspensions will be specially adjusted for you! Because of this please inform us about your weight with clothes and helmet, the weight of your luggage (perhaps pillion rider), where you ride (street, off-road, race) and how you ride (sport, touring, and so on) in the „comment“ of your order.

You can choose any spring colour you like. High/Low speed compression separately adjustable, each 16 times (256 possibilities) (only Spin and Fusion)

Suspension rear: adjustable rebound preload adjuster

Suspension front: preload adjuster, 16 positions

For riders wanting the upmost from their machine
Exceptional cooling properties due to the use of heat diverting aluminium alloys, therefore constant shock absorption and longer life

Lightweight through use of high quality materials

Adjustable length is standard

Recognised safety certificate

For BMW R850/1100RS 93-*

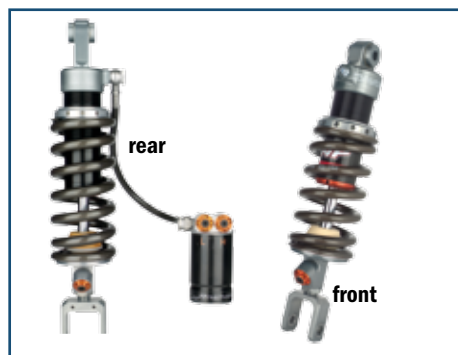

ArtNo.	Description	Price
17.06.P9.67	Emulsion suspension rear	€ 549,00
17.06.P8.67	Fusion suspension with reservoir fixed by a steel flex rear	€ 849,00
/02	Hydraulic preload adjustment	€ 229,00
17.06.P9.65	Emulsion suspension front	€ 549,00
17.06.P7.65	Spin suspension with fixed reservoir front	€ 899,00



R 1200 GS, ADVENTURE & HP2

R1200GS

built since 2004

R1200GS Adventure

built since 2006

HP2

built since 2005

We moved!

Motorradzubehör Hornig GmbH
Gewerbepark Chammünster Nord C 5
93413 Cham
Germany

Tel: +49 (0)9971 99 66 10
Fax: +49 (0)9971 99 66 110



Cham. The Motorcycle Accessory Hornig GmbH presents their BMW R1200GS conversion at the beginning of the new motorcycle season. The R1200GS is available since 2004, but BMW launched a face lift model in 2008 of the most popular bike in the world. The company Hornig from the Bavarian forest developed among other parts Extra Lights for the new R1200GS in order to have a better view at night but also be seen more easier and faster from other car drivers. These Extra Lights are mounted under a special side cover which can be made of GRP or Carbon Fibre.

Consistent with the red painting a red Rear Hugger was mounted, which not only protects the legs of the rider and pillion rider from water but also the whole bike from dirt and spread water.

Also the seat was changed and the new V-Stream windscreen ensures the wind protection on longer trips.

Many other items provide small but very useful extras for example the GPS Mounting above the Speedo, the Chrashbars, the Side-stand heightening and the mirror extensions. The handle bar risers provide not only more comfort when you sit on the bike but also when you stand on it while you drive off road and many small aluminium items made from the company Hornig round out this R1200GS conversion.



GPS Mounting 1

Made of high quality aluminium CNC machined. No drilling necessary.

The windscreen can still be used in all positions.

For Garmin SPIII, SP26**, 2720, Zumo 550, Zumo 660 and Nüvi.

SP26** & 2720 owners will need to purchase the Garmin Motorcycle Mount, available from: Global Positioning Systems.

The „Zumo-Ad schraeg“ is an angular adapter for all Garmin Navigators and can be used by riders who are taller than 180cm to improve the view of the navigator.

Also suits Garmin Quest using

Garmin Part: 010-10610-00

Colour: Anodized Silver, weight:260g

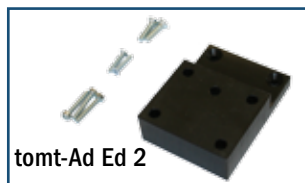

ArtNo.	Description	Price
44000	GPS Mounting for R1200GS (until 2007 model)	€ 89,90
44010	GPS Mounting for R1200GS (2008 -)	€ 94,90
Zumo-Ad	This adapter is made for all Garmin SPIII, SP26**, 2720 & Zumo. With this adapter the GPS is 12mm closer to you and it can be dislocated 7,5mm or 15mm higher or lower as usual. You need this option for the Zumo's bus bar. Made of black Pom incl. all screws.	€ 9,95
tomtom-Ad	Adapter for TomTom Rider Incl. screws for mounting in the GPS mount and the TomTom holder.	€ 9,55
tomt-Ad Ed 2	Adapter for TomTom 2nd Edition Incl. screws for mounting in the GPS mount and the TomTom holder.	€ 14,90
ram-1zoll	Adapter for 1" Ram-Ball	€ 29,90
Zumo-Ad schraeg	Adapter angular for Garmin Zumo	€ 15,90
tomt-Ad Ed 2 schraeg	Adapter angular for TomTom 2nd Edition	€ 16,50



GPS Mounting (TomTom/Zumo)

Made of high quality aluminium CNC machined and anodized. Easy and quick mounting.

No vibrations.

Always perfect view on the display. No drilling is necessary. The windscreen can still be used in all positions.

Because of its shape the mounting is perfect for TomTom; TomTom Edition 2 and ZUMO (don't forget to order the correct adapter).

ArtNo.	Description	Price
44008	GPS Mounting for R1200GS (-2007 model)	€ 94,90
44009	GPS Mounting for R1200GS (2008-*)	€ 98,95
Zumo-Ad	This adapter is made for all Garmin SPIII, SP26**, 2720 & Zumo. With this adapter the GPS is 12mm closer to you and it can be dislocated 7,5mm or 15mm higher or lower as usual. You need this option for the Zumo's bus bar. Made of black Pom incl. all screws.	€ 9,95
tomtom-Ad	Adapter for TomTom Rider Incl. screws for mounting in the GPS mount and the TomTom holder.	€ 9,55
tomt-Ad Ed 2	Adapter for TomTom 2nd Edition Incl. screws for mounting in the GPS mount and the TomTom holder.	€ 14,90
ram-1zoll	Adapter for 1" Ram-Ball	€ 29,90
Zumo-Ad schraeg	Adapter angular for Garmin Zumo	€ 15,90
tomt-Ad Ed 2 schraeg	Adapter angular for TomTom 2nd Edition	€ 16,50



GPS Mounting HP2 & HP2 Megamoto

Bolt + Ram-Ball with M10 x 1,25 thread.

CNC machined for TomTom Rider 2 and Garmin Zumo. You can mount all Ram-Mounts on the Ram-Ball.

Colour: Black

Can just be mounted with the Mirror Extensions BK 02R

ArtNo.	Description	Price
NH 1/7	GPS Mounting black	€ 24,95
BK 02R	Mirror Extension 1 Set	€ 49,95

GPS Mounting Adventure

Easy and fast mounting is possible with our new GPS Mounting for BMW R1200GS Adventure.

The windscreen can still be used in all positions and you always see your GPS without looking away from the street.

No vibrations!

For Garmin SPIII, SP26**, 2720, Zumo 550, Zumo 660, Nüvi and all BMW Navigators, GPS SP26** & 2720 owners will need to purchase the Garmin Motorcycle

Mount. (see pictures)

Colour: Anodized Silver

In order to provide the necessary distance from the screen you need the Zumo adapter (article no.: Zumo-Ad).for all Garmin and BMW Navigators.



ArtNo.	Description	Price
44002	GPS Mounting for R1200GS Adventure	€ 39,90
Zumo-Ad	This adapter is made for all Garmin SPIII, SP26**, 2720 & Zumo. With this adapter the GPS is 12mm closer to you and it can be dislocated 7,5mm or 15mm higher or lower as usual. You need this option for the Zumo's bus bar. Made of black Pom incl. all screws.	€ 9,95
tomtom-Ad	Adapter for TomTom Rider Incl. screws for mounting in the GPS mount and the TomTom holder.	€ 9,55
tomt-Ad Ed 2	Adapter for TomTom 2nd Edition Incl. screws for mounting in the GPS mount and the TomTom holder.	€ 14,90
ram-1zoll	Adapter for 1" Ram-Ball	€ 29,90

Mirror Extensions

Our Mirror Extensions are the perfect solutions if you see mainly your shoulders in the mirrors.

The mirrors will be moved a few centimetres out in order to improve the view to the rear.

ArtNo.	Description	Price
BK 02	Mirror Extensions (M10) R1200GS & Adv.	€ 49,95
BK 02R	Mirror Extensions HP2 & HP2 Megamoto	€ 49,95





Design A



Design B

Swing arm pivot cover

These covers are the perfect replacement for the original plastic caps. Made of high quality and very light aluminium in different versions and designs (A or B).

ArtNo.	Description	Price
--------	-------------	-------

Design A for R1200GS, Adv.

0-4-350	right polished	€ 19,40
0-4-351	right anodized	€ 19,90
0-4-150	left polished	€ 19,60
0-4-151	left anodized	€ 19,90

Design B for R1200GS, Adv.

0-4-34	right polished	€ 16,90
0-4-35	right anodized	€ 16,90
0-4-36	right black anodized	€ 16,90
0-4-14	left polished	€ 15,90
0-4-15	left anodized	€ 16,40
0-4-16	left black anodized	€ 16,70

Design B right or left for HP2

0-4-39	polished	€ 15,90
0-4-37	anodized	€ 16,50
0-4-38	black anodized	€ 16,60



Shift lever extension

Many BMW riders think that their shift lever is a little too thin and doesn't give enough grip when they're shifting. This enlarger will solve this problem for you as it offers more grip and a more sporty look for your bike. Available in polished or anodized.

ArtNo.	Description	Price
--------	-------------	-------

0190	polished	€ 21,40
0390	anodized	€ 21,80
0195	polished with o-rings	€ 23,50
0395	anodized with o-rings	€ 23,90
19x3	O-ring	€ 0,65

Brake pedal enlarger

This special part is made of extremely handy aluminium and cares for safe braking. It gets mounted with two screws, u-screws, nut and hulls which are all yet with the enlargement.

You can download the install instruction [ONLINE!](#)

ArtNo.	Description	Price
0140	Aluminium	€ 18,95
0140-1	anodized	€ 19,90



Telelever end caps

Aluminium cap, natural anodized or polished.
We send the caps in a set (2 parts).

ArtNo.	Description	Price
0095	1 Set polished	€ 29,80
0295	1 Set silver anodized	€ 29,90
0296	1 Set black anodized	€ 29,95



Cover

Covers for the fluid reservoirs.

You simply stick them onto the fluid reservoirs. Can be removed them without residue.
Made of high quality aluminium.

They are sold in a set of two.

ArtNo.	Description	Price
0700	1 Set polished	€ 39,80
0701	1 Set anodized	€ 39,90
0702	1 Set black anodized	€ 39,95
s2ml	Silicone 2ml	€ 0,40



Foot brake fluid reservoir cover

Cover for the foot brake fluid reservoir CNC machined of aluminium. polished.

Image shows K1200R.

But it is also visible on: R1200GS.

ArtNo.	Description	Price
0706	polished	€ 19,90
0706-1	anodized	€ 20,90
s2ml	Silicone 2ml	€ 0,40



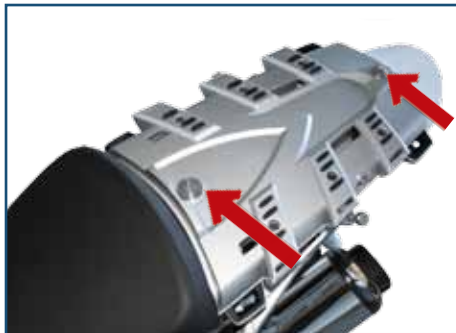

Rear seat caps

You can use these two covers in order to fill the holes if you have removed the rear seat and the grips. Available in polished or anodized.

The front cover fits the rear seat lock exactly and is very easy and fast to fit or remove.

ArtNo.	Description	Price
0510	Cover front polished	€ 19,90
0511	Cover front anodized	€ 20,90
0512	Cover rear polished	€ 5,40
0513	Cover rear anodized	€ 5,90



Centre cap top yoke

This part is an optical improvement for your top yoke as it is made of robust aluminium with an emblem.

An integrated o-ring ensures a snug fit.

ArtNo.	Description	Price
0060	polished	€ 24,60
0260	anodized	€ 24,90
0262	black anodized	€ 23,95
0065	polished (without emblem)	€ 18,95
0265	anodized (without emblem)	€ 18,95

Crashbars ZTechnik

ZTechnik's stainless steel Engine Guards will never rust like powder coated steel guards. They are carefully designed to allow clearance for oil changes or valve cover access, so they never need to be removed. Guards attach to the engine mounts not the engine covers to protect the engine heads and not destroy them. Integrated top brackets on each guard allow the rider to mount accessory lights, video cameras, or whatever they can imagine!
BMW R1200GS 04-09



ArtNo.	Description	Price
Z7101	Crashbars ZTechnik	€ 299,00

Engine cover

Made of 3mm aluminium with the latest laser-cutting and bending technology. Available in 2 versions (with/without grid) with 2 colours (natural/black anodized). Easy and fast mounting to the original attachment points.

1 Set (for left & right side) incl. fasteners and install instructions.

Note: Not with a Crashbars combined.

Fits all R1200GS bikes from 2004-2009!

ArtNo.	Description	Price
0620	1 Set anodized	€ 99,00
0621	1 Set black anodized	€ 105,00
0622	1 Set anodized with grid	€ 119,00
0623	1 Set black anodized with grid	€ 125,00



Oil cooler

Perfect protection for your oil cooler which looks nice, made of high-quality aluminium.

The lattice is surrounded by a solid frame and keeps insects or dirt away from the oil cooler.

Fitting instructions included.

ArtNo.	Description	Price
R1200GS & Adv. 04-07		
kg-12gs	anodized	€ 45,90
kg-12gs-s	black anodized	€ 48,90
R1200GS & Adv. 08-09		
kg-12gs08	anodized	€ 46,90
kg-12gs08-s	black anodized	€ 49,90
R1200GS & Adv. 10-*		
kg-12gs10	anodized	€ 48,90
kg-12gs10-s	black anodized	€ 51,90



Stainless steel tank grille

Grille for the lateral openings on the left and on the right tank sides. Made of high-quality aluminium. Mount with a hot glue gun or silicon. Set consists of 2x the emblem-part and 2x the other cover.

ArtNo.	Description	Price
0810	Tank lattice R1200GS MY 04-07	€ 24,95
0811	Tank lattice R1200GS MY 08-*	€ 24,90
s10ml	Silicone 10ml	€ 0,80





Number Plate Deflector

Made of 1mm high quality stainless steel. This guard is pre drilled to mount behind the rear number plate. It is very effective at keeping the luggage, pillion & rider clean of mud and dirt.

Fits BMW R 1200 GS & Adv.,

ArtNo.	Description	Price
42000	Width 200mm	€ 28,90
42001	Width 175mm	€ 28,90



Oil filler plug with emblem

There is a drilling in the side of the plug in which you can put a size 3 Allen key or a Torx key T10 (usually found in the your BMW toolkit) in order to fit and remove it.

ArtNo.	Description	Price
0045	polished	€ 25,80
0245	anodized	€ 25,90
0246	black anodized	€ 25,95



Oil filler plug

Oil filler plug Torx, made of high-quality aluminium.

Use a Torx tool T45 from your BMW tools in order to fit and remove the oil filler plug.

Choose between the polished, the anodized and the black anodized version.

ArtNo.	Description	Price
0035	polished	€ 17,70
0015	anodized	€ 17,90
0016	black anodized	€ 19,90



Fork tube cover

Nice looking cover for the fork tube which works as a replacement for all plastic caps, kept firmly in place by an o-ring.

In order to replace all plastic caps you get 2 covers in a set.

ArtNo.	Description	Price
0120	1 Set polished	€ 19,90
0220	1 Set anodized	€ 19,95
0221	1 Set black anodized	€ 22,90

Crashbars

Our crashbars are made of high-quality steel and are special designed for your R 1200 GS models.

The crashbars are designed very robust and allow for an equal distribution of the forces by what you and your bike are protected in the best possible way.

The crashbar can also be combined with our Fairing-Crash Bars and the Auxiliary Light Kit.

Crashbars offer a very good protection but they can lower the bank.



ArtNo.	Description	Price
SBL.07.562.100	Crashbars silver (04-*)	€ 194,95
SBL.07.562.10100/B	Crashbars black (04-*)	€ 194,95
SBL.07.552.100	Fairing-Crash Bars silver (04-07)	€ 159,95
SBL.07.565.100	Fairing-Crash Bars silver (08-*)	€ 159,95
SBL.07.565.10100/B	Fairing-Crash Bars black (08-*)	€ 159,95
NSW.00.004.100	Auxiliary Light Kit (Fog Light) (04-*)	€ 99,95

You can also mount the Auxiliary Light Kit with a Mounting Kit (without crashbars) on your R1200GS MY 2008-*.

ArtNo.	Description	Price
NSW.07.563.100	Mounting Kit for Auxiliary Lights (08-*)	€ 34,95





Sidestand foot enlargement

Feel safer parking your bike on dirt or asphalt with a side stand foot enlargement.

More than 100% bigger contact area.

Made of high quality aluminium.

Black anodized. Easy to install.

The higher version article no. 0715 and article no.

0715-20 is about 20mm high (10mm can easily be

screwed on or off) and makes your bike standing

straighter that means you need much less power in order

to make it ready for driving.

Especially when you ride with luggage.

There is a video for this product online: www.mhornig.com

ArtNo.	Description	Price
0713	normal version R1200GS -05	€ 23,60
0715	normal version R1200GS 06- (model 08- without lowering)	€ 24,60
0715-20	Heightening R1200GS 06- (model 08- without lowering)	€ 7,90



Side stand foot enlargement (lowered)

This side stand foot enlargement fits all R1200GS MY

2008-* which are lowered. More than 100% bigger

contact area. Article no. 0719 and Article no. 0719-20 is

the higher version. This one is about 20mm high (10mm

can easily be screwed on or off) and makes your bike

standing straighter that means you need much less power

in order to make it ready for driving. Especially when you

ride with luggage.

ArtNo.	Description	Price
0719	normal version R1200GS 08-* lowered	€ 25,90
0719-20	Heightening R1200GS 08-* lowered	€ 7,80



Adjustable Foot pegs

The Vario Footrest System (Joint) will be mounted to the motorcycle like the original footpeg.

The adjustable Footrest system consists of 3 parts: Vario Joint, Vario Plate and the Footrest. All Items sold as a set for left and right.



Part 1

The Vario Footrest System (Joint) will be mounted to the motorcycle like the original footpeg. The Joint is silver anodized.



Part 2

The Vario Plate is the part between the Footpeg and the Vario Footrest System (Joint). The Vario Plate is available in 3 length. We recommend 50mm only for the pillion rider.



ArtNo.	Description	Price
--------	-------------	-------

For R1200GS MY 04-*

051 02 04 00	Driver Vario Footrest System	€ 41,90
--------------	------------------------------	---------

051 02 01 10	Pillion rider Vario Footrest System	€ 41,90
--------------	-------------------------------------	---------

For R1200GS Adv. MY 04-*

051 02 05 00	Driver Vario Footrest System	€ 41,90
--------------	------------------------------	---------

051 02 01 10	Pillion rider Vario Footrest System	€ 41,90
--------------	-------------------------------------	---------

Vario Plate and Footrest for all models

051 00 00 23	23mm Vario Plate	€ 44,50
--------------	------------------	---------

051 00 00 30	30mm Vario Plate	€ 44,90
--------------	------------------	---------

051 00 00 50	50mm Vario Plate (only pillion rider)	€ 45,90
--------------	---------------------------------------	---------

050 00 04 00 8	Super Grip Footrest black	€ 51,80
----------------	---------------------------	---------

050 00 04 00 1	Super Grip Footrest silver	€ 51,70
----------------	----------------------------	---------

050 00 01 00 8	Racing Footrest black	€ 29,90
----------------	-----------------------	---------

050 00 01 00 1	Racing Footrest silver	€ 29,95
----------------	------------------------	---------

Part 3

The Footpeg will be mounted to the Vario Plate.

The Super Grip Footpegs are available in silver with black rubber.

The Racing Footpegs are available in black or silver. All Items sold as a set for left and right.





Frame Infill Panels

Explore those wide open spaces on either side of the R1200GS and then use the stylish frame infill panels to cover and enhance.

Designed to hook behind the lower frame rail and locate under the edge of the seat at the top. No fixings are necessary, but optional use clips are supplied for the 'belt and braces' customer.

Available in a silver or satin black finish.

DOES NOT FIT WITH THE BMW GENUINE LOW SEAT ADD-ON ACCESSORY!

ArtNo.	Description	Price
240010B	Pair of side covers black	€ 99,90
240010A	Pair of side covers in silver	€ 99,90

Cockpit cover

The cockpit cover is attached directly under the wind-screen and disguises the free space between speedo and headlight unit. Powder coated cover and Stainless steel attachments all included in the set. Totally new optics for the R1200GS & Adv. with or without windscreen. The cover can be installed as well as the instrument screen (article number TT.01-044-0560-0).

ArtNo.	Description	Price
TT.01-044-0550-0	Cockpit cover 2004-2007	€ 27,90
TT.01-044-0552-0	Cockpit cover 2008-*	€ 27,90



Instrument screen

The instrument screen disguises the Speedo of the R1200GS & Adv. An additional electrical system plug socket with safeguard unit is integrated. Thus mobile telephones or GPS devices can be plugged directly into the cockpit without messy connecting cables halfway round the motorcycle. Direct connection allows use of devices without the ignition being switched on, a problem with the R1200GS. This screen is black powder-coated aluminium and combined with Stainless steel attachments.

ArtNo.	Description	Price
TT.01-044-0560-0	Instrument screen 2004-2007	€ 39,90
TT.01-044-0563-0	Instrument screen 2008-*	€ 39,90



Speedometer Cover

In order to customize your BMW R1200GS's or R1200GS Adventure's speedo. Made of milled or laser cutted aluminium, polished or anodized.
Very easy to mount with usual silicon. An install instruction is included in the set for the speedo and the revolution counter.

ArtNo.	Description	Price
0411	1 Set polished	€ 74,90
0411-1	1 Set anodized	€ 74,95
s10ml	Silicone 10ml	€ 0,80



Axle pivot Cover

This cover for the axle pivot for all new R1200, K1200 and K1300 bikes gives a nice looking finish to the rear end and gives your motorcycle a classy look.

ArtNo.	Description	Price
0072	polished	€ 21,90
0172	anodized	€ 21,90
0272	black anodized	€ 21,90



Frame cover

This cover for the open hole beyond the swing arm pivot is made of aluminium and available in different versions. It gets fixed on the right side.

ArtNo.	Description	Price
0340	polished	€ 12,45
0440	anodized	€ 12,70
0441	black anodized	€ 12,80



Adjustable shift lever

The individually adjustable shift lever offers the optimum fit that the original shift lever does not. Shift lever has hinged end with return springs, helping to reduce damage.

Forces which affect the shift lever are transmitted less strongly to the control shaft.

If the hinged shift lever should be bent somehow, it can be bent straight very easily.

ArtNo.	Description	Price
TT.01-044-0432-0	Adjustable shift lever	€ 41,90





Rear wheel centre cover

Rear wheel centre lug cover with emblem.

The holes in the covers serve for cooling!
The lower temperature is based on the special angles of the drillings, which cause a little bit more concentrated air flow, but don't be worried it doesn't affect the drivability of your BMW.



ArtNo.	Description	Price
0116	polished	€ 61,90
0216	anodized	€ 62,90
0316	black anodized	€ 63,40



Handle Bar Risers 1200GS & Adv. 04-07

Handlebar adapter lifts 40 mm higher and 40 mm nearer, or only 30 mm higher. A change brake hose is not necessary with this modification.

(R1200GS until 2007 model)

ArtNo.	Description	Price
K.LAR1200	Handle Bar Risers 40mm & 40mm closer to the rider	€ 105,95
040-0274	Handle Bar Risers 30mm	€ 49,00



Handle Bar Risers R1200GS & Adv. 08-*

There are 20mm and 40mm versions of this part, which roughly equates to 3/4 inch and 1-1/2 inch respectively. The 40mm set consists of double blocks and longer bolts as can be seen in the image below. The shape and finish of the risers complements the existing parts well. The ability to turn the upper portions of the clamps by 180 degrees is retained.

You need for the mounting E10 and E12.

ArtNo.	Description	Price
LAR12/08/20	Handle Bar Risers 20mm	€ 39,90
LAR12/08/40	Handle Bar Risers 40mm	€ 59,90

Synto brake- and clutch lever

Synto is the name of the 6x adjustable CNC high-precision brake and clutch made of aluminium. Combines elegance and functionality. Handling pure!

- * 6 x adjustable CNC high-precision levers
- * Racing proven Extremely light weight / 60g per lever
- * CNC milled from high tech aeronautical norm aluminium EN 2017
- * Perfect design – convincing finish
- * Brilliant control feeling * Aerodynamic louver
- * Levers ca. 2 cm shorter than original
- * Predetermined breaking point at long version
- * Adjuster colour is always black, only the black lever has a silver adjuster * For brake and clutch
- * Including street homologation TÜV partcertificate (ABE)

There is a video for this product online: www.mhornig.com



ArtNo.	Description	Price
BH27-BKH1-15-11-L	black-silver	€ 218,00
BH27-BKH1-17-15-L	red-black	€ 218,00
BH27-BKH1-14-15-L	blue-black	€ 218,00





Fork-Crash-Pads

These crash-pads for forks are made of cnc lathed plastic (Nylon). The mounting is made of cnc milled and anodized aluminium.

These crash pads provide additional protection for your fork.

Shipment includes the crash pads (left and right) and the mounting.

ArtNo.	Description	Price
FP100	Fork-Crash-Pads	€ 49,00



Nautilus Stebel Horn

The Nautilus Stebel Horn ensures with its 139 db that you get the necessary respect and that you won't be overlooked. Because of its E-approval mark it is street legal in the EU.

We offer also a mounting kit for the Nautilus Stebel Horn. This mounting kit consists of a stainless steel mounting fitting for your BMW R1200GS and the necessary ready-to-install wiring.

ArtNo.	Description	Price
11690120	Nautilus Stebel Horn	€ 45,00
11690120R12GS	Mounting and wiring	€ 54,00

Crashbars ZTechnik DOHC

ZTechnik's stainless steel Engine Guards will never rust like powder coated steel guards. They are carefully designed to allow clearance for oil changes or valve cover access, so they never need to be removed. Guards attach to the engine mounts not the engine covers to protect the engine heads and not destroy them. Integrated top brackets on each guard allow the rider to mount accessory lights, video cameras, or whatever they can imagine!

BMW R1200GS 10-*

ArtNo.	Description	Price
Z7102	Crashbars ZTechnik	€ 299,00



LED turning signals

Awesome brightness, fitted in seconds and including electronics on the back of the panel to ensure the correct flash rate. It is the complete turning signal and has a homologation. So it is the first road legal LED for BMW bikes! The LEDs flash yellow.
Sold in pairs (for left and right).

ArtNo.	Description	Price
01006	1 pair of LED turning signals with clear lenses	€ 89,95
01006-g	1 pair of LED turning signals with grey lenses	€ 89,95



Clear indicator lens

Clear indicator lenses. Sold in a set (2 pieces).
And if you want, also single.

With E-Mark, so they are homologated for the EU.
Shipping: 2 lenses incl. orange bulbs.

ArtNo.	Description	Price
CTS-0037	Clear indicator lens	€ 20,90
CTS-0037-g	Grey indicator lens	€ 20,95



Indicator bulb

Either orange or special coated. The special coated one only lights orange when you use the indicator (usually used with transparent lenses).
Single

ArtNo.	Description	Price
BLWB-CBUS	orange 12V/10W	€ 2,55
BLWBT-CBUS	special coated 12V/10W	€ 5,99



Clear tail light lens

White rear light with long-life LEDs. Super optics, quick installation and with E-mark. Specially adapted to the electrics of the R1200GS & Adv. - 2007.
The LED rear light gives your motorcycle an entirely new appearance. You need not constantly worry either that the lamp in the rear light is broken, thus making you an accident risk.

ArtNo.	Description	Price
TT.044-0395	Clear tail light lens + LED	€ 59,95
0867	White tail light lens + LED	€ 59,90





Clear lens + LED

Far brighter than the standard set up!
Fitted in seconds by anyone.
Features up to 24 red high intensity LEDs
Fits for HP2.

ArtNo.	Description	Price
40106-01	Without Integral ABS	€ 84,95
40106-02	With integral ABS (with or without cruise control)	€ 89,95



LED tail light panel

Fitted in seconds by anyone. Features 24 red high intensity LEDs and 4 white ones for the number plate. The circuit board also includes suitable electronics to avoid the Integral Brake System (IBS) system thinking that the bulb has been changed/has blown. The tail light panel is FULLY compatible with the CAN-Bus wiring system used on this model. This design version has a different lighting pattern for a really attention grabbing look!

ArtNo.	Description	Price
10105-01	Normal LED Light Panel	€ 83,90
10105-02	Design LED Light Panel	€ 87,70



GS Sticker

These GS sticker fit perfect into the GS stamping of the R1200GS but they can also be used on all GS bikes. Available colours are red , black and silver. The silver GS sticker fits perfect to carbon fibre items. One set of GS stickers includes two stickers, one for the left and one for the right side.

ArtNo.	Description	Price
GS-red	GS Sticker red	€ 7,40
GS-black	GS Sticker black	€ 7,40
GS-silver	GS Sticker silver	€ 7,40



Dash pad

Carbon look - protects this very visible part of your bike from your keys and enhances its appearance with this scratch resistant, self adhesive pad.

ArtNo.	Description	Price
80069	Dash pad R1200GS 04-07	€ 6,70
80063	Dash pad R1200GS 08-*	€ 7,50



Carbon Reservoir-Cover Kit

Cover Kit for reservoirs of brake and clutch fluid reservoirs with carbon surface. The carbon fibre parts are precisely shaped and are to be fitted by glue.

ArtNo.	Description	Price
400.10.40	1 Set Reservoir-Covers	€ 59,00
s2ml	Silicone 2ml	€ 0,40



Carbon Aerial Conductor

Fits for R1200GS & Adv. MY 08-*

You can very easily exchange the original aerial conductor with our carbon fibre aerial conductor and improve the whole design for your bike. You just glue the Carbon Aerial Conductor on to the original plastic version.

ArtNo.	Description	Price
250.10.14	Aerial Conductor	€ 79,00
s10ml	Silicone 10ml	€ 0,80



Carbon Tank Centre Panel

Fits for R1200GS MY 08-*

You see on the picture just the centre panel of the tank without any other covers made of high quality carbon fibre and covered with clear varnish for protection.

ArtNo.	Description	Price
TAO.066.120GS.K	Tank Centre Panel	€ 399,90





Carbon Handguards

Fits for R1200GS & Adv. MY 08-*

These handguard scarfs are made of high quality carbon fiber which is usually only used in professional motor-sport. They are made for replacing the original scarfs. The article is sold in a set for the left and for the right side.

ArtNo.	Description	Price
HPR.064.120GS.K	Handguards Scarfs (1 Set)	€ 199,90



Carbon Handguards

Fits for R1200GS & Adv. 04-07

Like all our carbon fibre parts, it is very light but extreme tough and it isn't easy to find comparable parts. Looks enormous great in combination with other carbon parts.

ArtNo.	Description	Price
110640	Handguards (1 Set)	€ 319,90



Carbon Side Covers

Fits for R1200GS MY 08-*

These Side Covers are completely made of high quality carbon fibre. This material is usually only used in motor-sport because it is very light but also very resilient. These items are sold in a pair for the left and right side with an ABE/Street homologation.

ArtNo.	Description	Price
TAS.065.120GS.K	Side Covers (1 Set)	€ 649,90



Carbon Tank cover

Fits for R1200GS MY 04-07 and Adventure all models.

The tank cover is made of carbon fibre and fit exactly on the R1200GS.

ArtNo.	Description	Price
200.10.11	Tank cover	€ 339,90

Carbon Tank side cover

These Tank Covers are made of high quality carbon fibre. This exclusive tank cover shows that you're aware of the privilege of riding a BMW. They are sold in a pair for the left & right side.

The BMW emblems will stay in place and can't be stolen again.

For your BMW R1200GS MY 2004-2007.

ArtNo.	Description	Price
110590	1Set Tank side cover	€ 629,90



Lower Carbon Side Cover

Fits for R1200GS MY 08-*

These Lower Carbon Side Covers under the front part of the seat are made of high quality carbon fibre. They are bigger than the original plastic parts and protects the injections of your BMW R1200GS very good.

They are always sold in set for the left and right side.

ArtNo.	Description	Price
ASR.069.120GS.K	Lower Carbon Side Cover (1 Set)	€ 279,90



Carbon Beak

With this carbon fibre beak you can very easy exchange the original plastic beak of your BMW R1200GS and R1200GS Adventure MY 2008-.* and add some special material to your bike which is usually only used in the Formula 1.

ArtNo.	Description	Price
SV0.067.120GS.K	Beak	€ 389,90





Carbon Rear Hugger

Provides ultimate protection for the rear shock absorber!
Spend less time in cleaning, more time riding!
The best fit possible is provided by an aluminium fastener, with or without ESA.

If you ride your BMW R1200GS with side cases you need special clamps for the luggage rack (see Product Choice below).

With EU-Homologation.

ArtNo.	Description	Price
KHO.061.120GS.K	Rear Hugger GSA and GS without ESA	€ 229,90
KHO.063.120GS.K	Rear Hugger for GSA and GS with ESA	€ 239,90
SKO.062.120GS.A	Set (2) clamps for Luggage rack GS	€ 39,90
SKO.063.12GSA.A	Set (2) Clamps for Caseholder GS Adventure	€ 39,80



Rear Hugger

Fits between the rear shock and wheel and extends rearwards to finish near the end of the exhaust.
Designed specifically to keep road debris & water from the backs of riders/passengers legs, shock, gearbox, battery and centre stand. Developed for the street but suitable for off-road to a limited extent.

If you ride your BMW R1200GS with side cases you need special clamps for the luggage rack.

(See: KHO.063.120GS.K or SKO.062.120GS.A)

Fits all R1200GS MYS.

There is a video for this product online: www.mhornig.com

ArtNo.	Description	Price
40089	Rear Hugger black primed	€ 198,90
SKO.062.120GS.A	Set (2) clamps for Luggage rack GS	€ 39,90
SKO.063.12GSA.A	Set (2) Clamps for Caseholder GS Adventure	€ 39,80



Carbon Front Mudguard

It is perfect customised for the R 1200 GS.

With its widening in the back it almost stops the water splashes.

Dirt and mud can't stay at the front fender because it has no footbridges.

Weight ca. 184 gram light but very solid. Including ABE.
For all R1200GS models.



ArtNo.	Description	Price
110560	Front Mudguard	€ 239,90
KVO.060.120GS.K	Front Mudguard 17"	€ 279,90

Carbon Brake line cover

This cover protects the brake line of your R1200GS (all MYs) in the best possible and the best looking way.



ArtNo.	Description	Price
110680	Brake line cover	€ 99,90

Heel guards carbon fibre

Heel guard for the right made of carbon fibre.

A small but highly visible enhancement.

Easy to install.

Protects rear brake cylinder from damage. Fits all R1200GS MYs.



ArtNo.	Description	Price
110670	Heel guards carbon fibre	€ 89,90

ABS resin mud guard

This solid rear hugger is made of ABS resin plastics and provides perfect protection for your suspension, your exhaust, your header and for the whole rear part of your bike. Not to forget your pillion rider!

Everything you need to install it is included.
With ABE (European homologation).



ArtNo.	Description	Price
5055N	ABS resin mud guard	€ 184,00

Extra Lights

You can mount our extra lights which are Hella fog lights with our side fairings made of glass fibre (white primed) instead of the original metal side fairing on your BMW R1200GS MY 2008-.*.

You will not only be better seen but your bike will also look much better!

Shipment:

- 1x Handle Bar Switch
- 2x Fog Lights
- 2x Stainless Steel Mountings
- 1x Wire Set
- 1x Mounting instruction with colour pictures
- 2x Side Fairings in GRP

There is a video for this product online: www.mhornig.com



ArtNo.	Description	Price
69001	Extra Lights with GRP Fairing	€ 499,00

Beak enlargement

Give your GS a very sporty and distinctive look with this beak enlargement.

It is very easy to install without any modifications.

ArtNo.	Description	Price
7694390	Beak enlargement for R1200GS 04-07	€ 49,00
7705386	Beak enlargement for R1200GS 08-*	€ 49,95

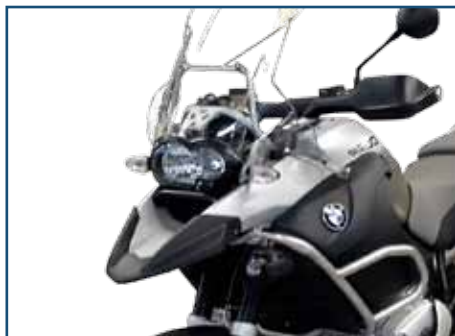

Extenda Fender

The rear section of the front fender is not long enough to effectively keep road debris off the exhaust and front of the engine. The fender extender solves this problem effectively and elegantly. Made of tough ABS plastic the extender attaches to the original fender with stainless steel screws which are of course included.

ArtNo.	Description	Price
054160	Extenda Fender	€ 28,90



Carbon Alternator cover

Extremely robust, nice cover for the alternator.

It is produced of light carbon fibre and quite easy to install.

Fits all 4V-boxer.

ArtNo.	Description	Price
110580	Alternator cover	€ 199,90



Carbon Engine Sump guard

This engine sump guard is extremely light (just 282 gram!) although its very tough.

It was especially designed for the R 1200 GS and not only looks perfect but is also suitable for hardcore off road riding.

It passed all our tests and is virtually indestructible. For all R1200GS MYS.

ArtNo.	Description	Price
110620	Engine Sump guard	€ 289,90





Carbon Rear Hugger HP2 Megamoto

Provides ultimate protection for the rear shock absorber. Spend less time cleaning, more time riding!

ArtNo.	Description	Price
KHO.001.HP2ME.K	Rear Hugger	€ 269,90



Carbon Engine Spoiler HP2 Megamoto

Made of high quality carbon fibre. Easy to install. Incl. all fasteners and install instructions.

ArtNo.	Description	Price
VEU.002.HP2ME.K	Engine Spoiler	€ 849,90



Carbon handguards HP2 Megamoto

Like all our carbon fibre parts, it is very light but extreme tough and it isn't easy to find comparable parts. Looks enormous great in combination with other carbon parts. Fits BMW HP2 Megamoto.

Complete set for left and right. You need the original BMW Mounting in order to mount it.

ArtNo.	Description	Price
HPR.003.HP2ME.K	Handguards (1 Set)	€ 339,90

Carbon Speedo coating

Now you can easily change the boring and simple look of the speedo with our new sporty carbon pigment speedo. You can choose between a carbon pigment covered speedo or you can send us your speedo and we'll cover it.

ArtNo.	Description	Price
cf-tachor12gs-d	We coat your speedo	€ 69,90
cf-tachor12gs	coated speedo	€ 172,90



Carbon Headlamp surround

Just like the speedo we can cover any water resistant surface with carbon fibre pigment like the „glasses“ of the R1200GS. You can choose again between the covered „glasses“ or you can send us your one and we'll cover it.

ArtNo.	Description	Price
cf-brille-d	We coat your headlight surround	€ 65,90
cf-brille	Carbon headlight surround	€ 96,90



Suspension protection

Just like the speedo we can cover any water resistant surface with carbon fibre pigment like the suspension protection of the R1200GS. Send us your suspension protection and we'll cover it for you.

ArtNo.	Description	Price
cf-federbs-d	We coat your suspension protection	€ 46,90



Additional information is available online: www.mhornig.com

Coating of the Spark Plug Covers

Just like the speedo we can cover any water resistant surface with carbon fibre pigment like the sparking plug covers. You can choose again between the covered covers or you can send us your cover and we'll cover them for you.

ArtNo.	Description	Price
cf-zuekabd-d	We coat your cover (1 piece)	€ 45,90
cf-zuekabd	Cover with Coating R1200GS 04-09 (1 p.)	€ 59,60



Cylinder protectors coated

Just like the speedo we can cover any water resistant surface with carbon fibre pigment like the cylinder protection. You can choose again between the covered protections or you can send us your protection and we'll cover them.

ArtNo.	Description	Price
cf-zyylinder-d	We cover your protection (1 piece)	€ 82,90
cf-zyylinder	Protection with Coating R1200GS 04-09 (1 p.)	€ 172,90





Air Deflector

These air deflectors for left and right side help keep the wind from your arms and shoulders. Sold in a set for the left and right.

The holes for the screws are not in the original fairing of the R1200GS. These are very easily drilled.

ArtNo.	Description	Price
399+400	Air Deflector	€ 44,40
ha-windabw-r12gs	Fastening for the air deflectors	€ 5,90



Windscreen Adventure

This windscreen is not only wider in the lower part than the original one but also higher.

That means this windscreen provides perfect protection for longer tours with a real off-road optic.

Dimensions: height 465mm; wide top 385mm; wide middle 340mm; wide „bottom“ 510mm.

The fastening for the R1200GS must be ordered extra.

Art-Nr.: 699349

ArtNo.	Description	Price
703196	Windscreen Adv. clear	€ 216,90
7708532	Windscreen Adv. smoke grey	€ 219,90
699349	Frame, truss and fastening set for R1200GS	€ 190,90



Vario Screen

The VarioScreen can be adjusted by angle or height. This screen has an additional wind channel.

Because of the wind channel and the adjustment facility, this screen can be adjusted to suit the requirements of the rider.

Height 450 - 500mm.

Fits for R1200GS & Adv. bikes.

ArtNo.	Description	Price
V-r1200gs-rg	Vario screen smoke grey	€ 159,90
V-r1200gs-k	Vario screen clear	€ 159,90

V-Stream Windshield

The „V-Stream“ Windshield set new standards for design, technology and comfort.

Made of Quantum/Lexan Polycarbonate which is 10x more scratch-resistant than usual Acrylic.

Windshield V-Stream, clear, with homologation,

For all R1200GS bikes.

ArtNo.	Description	Price
115108	Clear, Height 41cm, Width 41cm	€ 159,00
Z2243	Clear, adjustable, Height 41 cm, Width 41cm	€ 339,00
Z2414	Clear, Height 49cm, Width 45cm	€ 229,00





Sebring Twister

R1200 GS 04-09 model or newer, Type R12, 73.5 kW and R1200GS Adventure 06-09.

2 versions with 3 covers each

Choose the cover you like most! The exhaust is very easy to install and much lighter than the original one. But the most important argument is the deep and throaty sound combined with more power and more torque throughout the whole speed range. Real driving pleasure and of course with ABE (European Homologation)!

ArtNo.	Description	Price
TAT1032	slip on, with EG/ABE Aluminium	€ 444,00
TCT1032	slip on, with EG/ABE Carbon	€ 554,00
TTT1032	slip on, with EG/ABE Titanium	€ 554,00
TAT3101032	Exhaust system without cat., Aluminium	€ 944,00
TCT3101032	Exhaust system without cat. Carbon	€ 1048,00
TTT3101032	Exhaust system without cat., Titanium	€ 1086,00



Remus HexaCone

More than 2kg lighter compared to the original exhaust. Not only nice for the eyes but also powerful sound - the HexaCone.

Available with two covers: Carbon Fibre or Titanium and two insides: Full Titanium or normal

There is a video for this product online: www.mhornig.com

ArtNo.	Description	Price
For R1200GS, Adv. MY 04-09		
054682 088104L	Stainless Steel	€ 561,00
054882 088104L	Titanium Cover	€ 622,00
054482 088104L	Carbon Fibre Cover	€ 638,00
For R1200GS & Adv. MY 10-*		
054682 088010L	Stainless Steel Cover	€ 542,00
054482 088010L	Carbon Fibre Cover	€ 619,00
054882 088010L	Titanium Cover	€ 604,00
0101 088010	Header without cat	€ 548,00

Remus PowerCone

Remus PowerCone for your R 1200 GS & Adv. 04 model or newer, Type R12, 73.5 kW

With 3 covers each

Perfect Looking, quick and easy Mounting, less Weight, more Power, more Torque, deep and throaty Sound combined with ABE (European Homologation) Real riding pleasure!

ArtNo.	Description	Price
055682 088004L	Slip-on, with EG/ABE, Aluminium-Stainless steel	€ 486,00
055782 088004L	Slip-on, with EG/ABE, Stainless steel black	€ 516,00
055882 088004L	Slip-on, with EG/ABE, Titanium	€ 587,00



You can find more exhausts from Laser, Sebring, BOS and suspensions front & rear for the R1200GS, Adv. and HP2 online: www.mhornig.com

WP EDS II System

Our WP suspensions will be specially adjusted for you! Because of this please inform us about your weight with clothes and helmet, the weight of your luggage (perhaps pillion rider), where you ride (street, off-road, race) and how you ride (sport, touring, and so on) in the „comment“ of your order.

For extra charge you can choose any spring colour you like.

You now have the option to control the settings of your suspension with the touch of a button. The EDS system comes complete with all necessary parts, including bracket for the control module and an ECM. For all R1200GS bikes.

[There is a video for this product online!](#)



ArtNo.	Description	Price
11.06.Y0.01	EDS II System front & rear	€ 1699,00



Change front & rear seat

For all R1200GS & Adv. bikes

The drivers and pillion rider's seat are equipped with a fluting in order to release the tail bone. The seats were also broadened for about 15mm. The padding consists of two layers, the upper one comfortably soft and the lower one avoids denting. We especially took care of the pillion rider's comfort: Here, the seat is increased in the middle front part to inhibit a cramped position. These alterations care for a tangible comfortable riding - free from pain. Also the vexatious sliding when the driver brakes has an end now.

Your seat gets altered - you have to send it in!
The change takes about 2 weeks.

Available in three heights

(please note in the comment with the article number):

- 1: like the original one
- 2: lower (- ca. 25mm)
- 3: higher (+ ca. 25mm)

**You must send
your seat
to us!**

ArtNo.	Description	Price
sitzF	Driver's seat black	€ 189,00
sitzS	Pillion seat black	€ 184,00

Change one-piece seat

A distinct fluting (middle of the seat is deepened) releases the driver's tailbone and disperses the driver's weight all over his bottom. Also, the seat gets broadened for ca. 15 mm.

The padding consists of two layers, the upper one comfortably soft and the lower one avoids denting. Special contours for the pillion's seat avoid the slipping when the driver has to brake.



Available in three heights

(please note in the comment with number):

- 1: like the original one
- 2: lower (- ca. 25mm)
- 3: higher (+ ca. 25mm)

ArtNo.	Description	Price
sb	Change one-piece seat black	€ 289,00

You need a Tank bag, Tear Seat Bag, Duffel Bag,
Inside Bag, Universal Bag or Tool Bag?
You can find it under SOFT BAGS in the catalog
and online: www.mhornig.com





R1200R

built since 2006

1170 ccm cylinder capacity

power: 109 PS.

max. torque 115 Nm at 6.000/min.

R1200R Customisation

The Roadster leaves the factory as a purist bike, allowing loads of scope to enhance and modify.

Our philosophy with this model was to create a more sport oriented look, yet keeping to a discrete look with parts that are easy for the owners to fit themselves.

The concept is the product of a Spanish designer, ensuring that all elements combined into a cohesive whole. The result is an R in classic black with red stripe highlights and a few modifications.

A race sound is achieved by fitting a Remus PowerCone in Titanium, accenting well with the other aluminium parts fitted as well as increasing power by up to 4hp.

An extra sporty touch is the addition of a GRP spoiler, which may also be fitted with a front grille. It is still possible to use the centre stand, so ease of use remains unaffected.

A rear seat cover is available for those who travel solo. Also made of GRP this fits seamlessly into the design, but is quick and easy to remove for pillion use.

A small GRP screen, deliberately kept small to accentuate the purist Roadster character, nonetheless offers good wind protection, helping to reduce pressure on the neck on long journeys.

A rear hugger (GRP) stops dirt and splashes so that you arrive at your destination still relatively dry and clean. All GRP parts are supplied black primed (see picture) and can be painted in any colour if desired.

Small details are covers for the swing arm pivot, frame, fork tubes, final drive pivot, oil filler plug, rear axle, Telelever end caps and engine covers, all made of aluminium.

Mirror extensions improve the view to the rear. For increased rider comfort and safety gear and rear brake lever enlargements are fitted. The oil cooler is further protected with the addition of a cooler grille.

A side stand foot of black anodized aluminium offers safe parking anywhere.

In total this conversion offers a host of small highlights, all working together to create a distinctive sport look to the R1200R.



GPS Mounting

Handlebar mounting for 22mm handlebars + Ram-Ball with M10 x 1,25 thread;
CNC machined for TomTom Rider 2 and Garmin Zumo.
Ram-Ball mount may be used for many other items, too.

Colour: Black



With or without hinge in order to move your navigation system in the best position.

ArtNo.	Description	Price
NH 1/3 sw 22	GPS Mounting without hinge black	€ 34,95
NH 2/1 sw 22	GPS Mounting with hinge black	€ 44,95

Shift lever extension

Many BMW riders think that their shift lever is a little too thin and doesn't give enough grip when they're shifting.

This enlarger will solve this problem for you as it offers more grip and a more sporty look for your bike. Available in polished or anodized.

ArtNo.	Description	Price
0190	polished	€ 21,40
0390	anodized	€ 21,80
0195	polished with o-rings	€ 23,50
0395	anodized with o-rings	€ 23,90
19x3	O-ring	€ 0,65



Rear wheel centre cover

Rear wheel centre lug cover with emblem.

The holes in the covers serve for cooling! The lower temperature is based on the special angles of the drillings, which cause a little bit more concentrated air flow, but don't be worried it doesn't affect the drivability of your BMW.

ArtNo.	Description	Price
0116	polished	€ 61,90
0216	anodized	€ 62,90
0316	black anodized	€ 63,40





Number Plate Deflector

Made of 1mm high quality stainless steel. This guard is pre drilled to mount behind the rear number plate. It is very effective at keeping the luggage, pillion & rider clean of mud and dirt.

ArtNo.	Description	Price
42000	Width 200mm	€ 28,90
42001	Width 175mm	€ 28,90



Axle pivot Cover

This cover for the axle pivot for all new R1200, K1200 and K1300 bikes gives a nice looking finish to the rear end and gives your motorcycle a classy look.

ArtNo.	Description	Price
0072	polished	€ 21,90
0172	anodized	€ 21,90
0272	black anodized	€ 21,90



Fork tube cover

Nice looking cover for the fork tube which works as a replacement for all plastic caps, kept firmly in place by an o-ring. In order to replace all plastic caps you get 2 covers in a set.

ArtNo.	Description	Price
0120	1 Set polished	€ 19,90
0220	1 Set anodized	€ 19,95
0221	1 Set black anodized	€ 22,90



Telelever end caps

Aluminium cap, natural anodized or polished. We send the caps in a set (2 parts).

ArtNo.	Description	Price
0095	1 Set polished	€ 29,80
0295	1 Set silver anodized	€ 29,90
0296	1 Set black anodized	€ 29,95

Cover

Covers for the fluid reservoirs.
You simply stick them onto the fluid reservoirs. Can be removed them without residue.
Made of high quality aluminium.
They are sold in a set of two.

ArtNo.	Description	Price
0700	1 Set polished	€ 39,80
0701	1 Set anodized	€ 39,90
0702	1 Set black anodized	€ 39,95
s2ml	Silicone 2ml	€ 0,40



Foot brake fluid reservoir cover

Cover for the foot brake fluid reservoir CNC machined of aluminium, polished.
Image shows K1200R.
But it is also visible on: R1200R.

ArtNo.	Description	Price
0706	polished	€ 19,90
0706-1	anodized	€ 20,90
s2ml	Silicone 2ml	€ 0,40



Frame Cover

Cover for the hole above the swing arm journal.
Available in polished, anodized and black anodized version.

ArtNo.	Description	Price
0352	polished	€ 12,20
0453	anodized	€ 12,60
0454	black anodized	€ 12,95



Bar-end weights

These bar-end weights made of Stainless steel or aluminium show that BMW riders are aware of function and form.
Article number: 0805 stainless steel 220 gram each
Article number: 0806 aluminium 84 gram each
Shipment: 2 end weights, 2 screws.

ArtNo.	Description	Price
0805	1 Set Stainless steel	€ 32,90
0806	1 Set Aluminium anodized	€ 25,90





Oil filler plug with emblem

There is a drilling in the side of the plug in which you can put a size 3 Allen key or a Torx key T10 (usually found in your BMW toolkit) in order to fit and remove it.

ArtNo.	Description	Price
0045	polished	€ 25,80
0245	anodized	€ 25,90
0246	black anodized	€ 25,95



Oil filler plug

Oil filler plug Torx, made of high-quality aluminium.

Use a Torx tool T45 from your BMW tools in order to fit and remove the oil filler plug.

Choose between the polished, the anodized and the black anodized version.

ArtNo.	Description	Price
0035	polished	€ 17,70
0015	anodized	€ 17,90
0016	black anodized	€ 19,90



Swing arm pivot cover left

This cover is the perfect replacement for the original plastic cap.

Made of aluminium.

ArtNo.	Description	Price
0-4-14	polished	€ 15,90
0-4-15	anodized	€ 16,40
0-4-16	black anodized	€ 16,70



Swing arm pivot cover right

This cover is the perfect replacement for the original plastic cap.

Made of aluminium.

ArtNo.	Description	Price
0-4-39	polished	€ 15,90
0-4-37	anodized	€ 16,50
0-4-38	black anodized	€ 16,60

Engine cover

Made of 3mm aluminium with the latest laser-cutting and bending technology. Available in 2 versions (with/without grid) with 2 colours (natural/black anodized).

Easy and fast mounting to the original attachment points.

1 Set (for left & right side) incl. fasteners and install instructions.

Note: Not with a Crashbars combined.



ArtNo.	Description	Price
0620	1 Set anodized	€ 99,00
0621	1 Set black anodized	€ 105,00
0622	1 Set anodized with grid	€ 119,00
0623	1 Set black anodized with grid	€ 125,00

Synto brake- and clutch lever

Synto is the name of the 6x adjustable CNC high-precision brake and clutch made of aluminium.

Combines elegance and functionality. Handling pure!

* 6 x adjustable CNC high-precision levers

* Racing proven Extremely light weight / 60g per lever

* CNC milled from high tech aeronautical norm aluminium EN 2017

* Perfect design – convincing finish

* Brilliant control feeling * Aerodynamic louver

* Levers ca. 2 cm shorter than original

* Predetermined breaking point at long version

* Adjuster colour is always black, only the black lever has a silver adjuster * For brake and clutch

* Including street homologation TÜV part certificate (ABE)

There is a video for this product online: www.mhornig.com



ArtNo.	Description	Price
BH27-BKH1-15-11-L	black-silver	€ 218,00
BH27-BKH1-17-15-L	red-black	€ 218,00
BH27-BKH1-14-15-L	blue-black	€ 218,00

Sidestand foot enlargement

Feel safer parking your bike on dirt or asphalt with a side stand foot enlargement.

More than 100% bigger contact area.

Made of high quality aluminium.

Black anodized.

Easy to install.

ArtNo.	Description	Price
0710	Sidestand foot enlargement	€ 26,80



Adjustable Foot pegs

The Vario Footrest System (Joint) will be mounted to the motorcycle like the original footpeg.

The adjustable Footrest system consists of 3 parts: Vario Joint, Vario Plate and the Footrest.
All Items sold as a set for left and right.



Part 1

The Vario Footrest System (Joint) will be mounted to the motorcycle like the original footpeg. The Joint is silver anodized.



Part 2

The Vario Plate is the part between the Footpeg and the Vario Footrest System (Joint). The Vario Plate is available in 3 length. We recommend 50mm only for the pillion rider.



ArtNo.	Description	Price
051 02 03 00	Driver Vario Footrest System	€ 41,90
051 02 03 10	Pillion rider Vario Footrest System	€ 41,90
051 00 00 23	23mm Vario Plate	€ 44,50
051 00 00 30	30mm Vario Plate	€ 44,90
051 00 00 50	50mm Vario Plate (only pillion rider)	€ 45,90
050 00 04 00 8	Super Grip Footrest black	€ 51,80
050 00 04 00 1	Super Grip Footrest silver	€ 51,70
050 00 01 00 8	Racing Footrest black	€ 29,90
050 00 01 00 1	Racing Footrest silver	€ 29,95

Part 3

The Footpeg will be mounted to the Vario Plate. The Super Grip Footpegs are available in silver with black rubber.

The Racing Footpegs are available in black or silver.
All Items sold as a set for left and right.



Mirror Extensions

Our Mirror Extensions are the perfect solutions if you see mainly your shoulders in the mirrors. The mirrors will be moved a few centimetres out in order to improve the view to the rear.

ArtNo.	Description	Price
BK 02	Mirror Extensions (M10) (1 Set)	€ 49,95



Cooler screen

Perfect protection for your oil cooler which looks quite nice and is designed of high-quality aluminium and covered with a special protective aluminium alloy. Install instruction is included.

ArtNo.	Description	Price
kg-r12r	MY *-2010	€ 29,90
kg-r12r011	MY 2011-*	€ 29,95
s10ml	Silicone 10ml (2x needed)	€ 0,80



Brake pedal enlargement

Nicely machined aluminium, knurled and natural anodized.

This enlargement simply slips on and is held in place with a set-screw.

ArtNo.	Description	Price
0180	anodized	€ 22,15



Centre cap top yoke

This part is an optical improvement for your top yoke as it is made of robust aluminium with an emblem. An integrated o-ring ensures a snug fit.

ArtNo.	Description	Price
0060	polished	€ 24,60
0260	anodized	€ 24,90
0262	black anodized	€ 23,95
0065	polished (without emblem)	€ 18,95
0265	anodized (without emblem)	€ 18,95





Handlebar Risers MY *-2010

Handlebars rise by 25 mm for R1200R.

- For an upright and relaxed riding position
- Less strain on shoulders and wrists
- For sport bikes: Better standing, less exhaustive riding
- German TÜV Type Approval

When using the original BMW fog lamps, you also require our special screw set (040-0272).

ArtNo.	Description	Price
040-0265	Handlebar Risers 25mm	€ 39,90
040-0272	Special screw-set 2x M8 x 65 with M4 thread	€ 19,90



Handlebar risers R1200R 2011-*

You'll notice a definite decrease in the stress on your wrists and shoulders. Your trip will be safer; you'll arrive more relaxed.

The riser is installed between the handlebars and the upper fork brace. The longer screws required are included in the kit.

What's included:

- Handlebar riser, 20 mm high on the left and right or Handlebar riser, 32 mm high, offset 20 mm toward the rider on the left and right
- Longer mounting screws
- Installation instructions
- Technical component report

ArtNo.	Description	Price
01-610-5255-0	Handlebar risers 20mm	€ 44,90
01-610-5257-0	Handlebar risers 32mm, 20mm	€ 59,90



Nautilus Stebel Horn

The Nautilus Stebel Horn ensures with its 139 db that you get the necessary respect and that you won't be overlooked. Because of its E-approval mark it is street legal in the EU.

We offer also a mounting kit for the Nautilus Stebel Horn. This mounting kit consists of a stainless steel mounting fitting for your BMW R1200R and the necessary ready-to-install wiring.

ArtNo.	Description	Price
11690120	Nautilus Stebel Horn	€ 45,00
11690120R12R	Mounting and wiring	€ 49,00

Crashbars MY *-2010

Our crashbars are made of high-quality steel and are specially designed for your R 1200 R. The crashbars are designed to be very robust and provide an equal distribution of the forces to ensure that you and your bike are protected in the best possible way.

Crashbars offer a very good protection but they can reduce the lean angle.

ArtNo.	Description	Price
SBL.07.606.100/B	black	€ 149,95
SBL.07.606.100/S	silver	€ 149,95



Crashbars ZTechnik DOHC

ZTechnik's stainless steel Engine Guards will never rust like powder coated steel guards. They are carefully designed to allow clearance for oil changes or valve cover access, so they never need to be removed. Guards attach to the engine mounts not the engine covers to protect the engine heads and not destroy them. Integrated top brackets on each guard allow the rider to mount accessory lights, video cameras, or whatever they can imagine!

BMW R1200R 11-*

ArtNo.	Description	Price
Z7102	Crashbars ZTechnik	€ 299,00



Back lifter

Slide the rubber coated pipe of the Back lifter in the final drive of your BMW and lift it up. Easy to use by one person and very stable support for the bike. Made of high quality steel. Diameter 42mm, zinc-plated. The diameter of the rubber is 52,5mm.

ArtNo.	Description	Price
BT.heck-lifter	Back lifter	€ 89,90





Clear tail light

The clear tail light is available with a red bulb or LED and a grey tail light is available with LED.

Both LEDs have an E-mark and are very easy to install and fit perfectly.

ArtNo.	Description	Price
WLL-87-L	Clear lens with LED (not for model 08-)	€ 89,95
WLL-87-L-g	Grey lens with LED (not for model 08-)	€ 89,95



LED turning signals

Awesome brightness, fitted in seconds and including electronics on the back of the panel to ensure the correct flash rate. It is the complete turning signal and has a homologation. So it is the first road legal LED for BMW bikes! The LEDs flash yellow.

Sold in pairs (for left and right).

ArtNo.	Description	Price
01006	1 pair of LED turning signals with clear lenses	€ 89,95
01006-g	1 pair of LED turning signals with grey lenses	€ 89,95



Clear indicator lens

Clear indicator lenses. Sold in a set (2 pieces).

And if you want, also single.

With E-Mark, so they are homologated for the EU.

Shipping: 2 lenses incl. orange bulbs.

ArtNo.	Description	Price
CTS-0037	Clear indicator lens	€ 20,90
CTS-0037-g	Grey indicator lens	€ 20,95

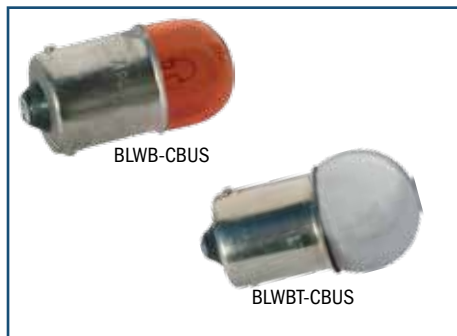

Indicator bulb

Either orange or special coated. The special coated one only lights orange when you use the indicator (usually used with transparent lenses).

Single.

ArtNo.	Description	Price
BLWB-CBUS	orange 12V/10W	€ 2,55
BLWBT-CBUS	special coated 12V/10W	€ 5,99

Rear Hugger

Fits between the rear shock and wheel and extends rearwards to end near the end of the exhaust. Designed specifically keep road debris and water from the backs of riders/passengers legs, shock, gearbox, battery and so on. It can be painted in any colour you like and fits 180 and 190 tyres.



ArtNo.	Description	Price
40095	Rear Hugger black primed	€ 199,90

Rear seat cover

Specially designed cover for the pillion seat made of high quality glass fibre. Gives your BMW R1200R a very sporty look. Note: The article number 40211 fits only for original seats up to year 2007, the article number 40212 fits original seats MY 2008-*.
Remove the seat, slide on the rear seat cover and mount the seat again.



ArtNo.	Description	Price
40211	Cover for the pillion seat -07	€ 159,00
40212	Cover for the pillion seat 08-*	€ 164,90

Engine Spoiler

Our engine spoiler is specially designed for your R1200R and made of high quality glass fibre reinforced synthetic material and black primed or manufactured of carbon fibre. Because of our elaborate mounting systems it is very easy to install.

Incl. all fasteners and install instructions.
Note: The angle freedom is somewhat restricted.

If you have no silicone you can also order our high quality silicone which is pre-filled in the volume you need and easy to apply.



ArtNo.	Description	Price
40213	GRP Engine Spoiler	€ 399,00
40111	Grid for the waterworks	€ 19,00
s10ml	Silicone 10ml (you need it 2x)	€ 0,80





Carbon Reservoir-Cover Kit

Cover Kit for reservoirs of brake and clutch fluid reservoirs with carbon surface. The carbon fibre parts are precisely shaped and are to be fitted by glue.

ArtNo.	Description	Price
400.10.40	1 Set Reservoir-Covers	€ 59,00
s2ml	Silicone 2ml	€ 0,40



Carbon Rear Mudguard

Provides ultimate protection for the rear shock absorber! Spend less time in cleaning - more time riding!

The best fit possible is provided by an aluminium fastener: fits 180 and 190 rear tyre and can be used with and without ESA.

ArtNo.	Description	Price
KHO.001.R120S.K	Rear Mudguard	€ 269,90



Carbon Brake line cover

This cover protects the brake line of your R1200R (all MYs) in the best possible and the best looking way.

ArtNo.	Description	Price
110680	Brake line cover	€ 99,90





Dash pad

Carbon look - protects this very visible part of your bike from your keys and enhances its appearance with this scratch resistant, self adhesive pad.



ArtNo.	Description	Price
80063	MY *-2010	€ 7,50
80073	MY 2011-*	€ 7,00

Carbon Oil Cooler Cover

Made of high quality carbon fibre. Easy to install.



ArtNo.	Description	Price
OKA.008.R120R.K	Oil Cooler Cover	€ 349,00

Carbon Rear Light Cover (Top)

Made of nice looking and high-quality carbon fibre. Is very light and looks brilliant.. As replacement for the aluminium cover.



ArtNo.	Description	Price
HA0.004.R120R.K	Rear Light Cover (Top)	€ 189,90





Carbon Bellypan

Made of high quality carbon fibre.
Easy to install.
Incl. all fasteners and install instructions.

ArtNo.	Description	Price
VEU.009.R120R.K	Bellypan	€ 849,90



Carbon Rear Light Cover

A pair for the left and right.
Made of high quality
and very good looking carbon fibre.

ArtNo.	Description	Price
RHO.005.R120R.K	Rear Light Cover (1 Set)	€ 329,90



Carbon Side panel set

A pair for the left and right side.
Made of high quality and very good looking carbon fibre.

ArtNo.	Description	Price
SED.006.R120R.K	Side panel set (1 Set)	€ 329,90



ABS resin mud guard

This solid rear hugger is made of ABS resin plastics and provides perfect protection for your suspension, your exhaust, your header and for the whole rear part of your bike. Not to forget your pillion rider!
Everything you need to install it is included.
With ABE (European homologation).

ArtNo.	Description	Price
5861N	ABS resin mud guard	€ 184,00

High Windscreen

Transparent and aerodynamic wind protection incl. mounting-kit and ABE.

Please order also the mounting kit.
Size (HxW): 49,5x46 cm

ArtNo.	Description	Price
147A	High Windscreen	€ 104,90
A147A	Mounting kit MY *-2010	€ 39,80
A5100A	Mounting kit MY 2011-*	€ 63,90



Windscreen

Our design windscreen is made of high quality glass fibre.

You simply mount it on the original BMW mounts
(Article no. 46 63 7 697 212).

As well as looking very sporty it provides quite good protection from the wind.

Height about 25 cm (from the lower screw).
Black primed (see picture)

ArtNo.	Description	Price
40200	Windscreen	€ 139,00



V-Stream Windshield

The „V-Stream“ Windshield set new standards for design, technology and comfort.

Made of Quantum/Lexan Polycarbonate which is 10x more scratch-resistant than usual Acrylic.

The windscreen will be shipped with everything you need to mount it.

Windshield V-Stream, light grey, with homologation

ArtNo.	Description	Price
115102	Height 48cm, Width 45cm	€ 279,00
Z2409	Height 55cm, Width 48cm	€ 309,00





Remus PowerCone

Remus PowerCone for your R 1200 R *-2010

With 3 covers each.

Perfect Looking, quick and easy Mounting, less Weight, more Power, more Torque, deep and throaty Sound combined with ABE (European Homologation) Real riding pleasure!

ArtNo.	Description	Price
055682 088206L	slip-on, Aluminium-Stainless steel	€ 486,00
055782 088206L	slip-on, black	€ 516,00
05882 088206L	slip-on, Titanium	€ 587,00



Remus HexaCone 2011-*

More than 2kg lighter compared to the original exhaust.

Not only nice for the eyes but also powerful sound - the HexaCone.

Available with three covers: Stainless Steel, Carbon Fibre or Titanium

ArtNo.	Description	Price
054682 088011L	Stainless Steel Cover	€ 526,00
054882 088011L	Titanium Cover	€ 588,00
054482 088011L	Carbon Fibre Cover	€ 603,00



You must send
your seat
to us!



How do you sit on your motorcycle seat? Do you want to change something in your seat?

Then read through the pages of the catalog **SEAT ALTERATION**.
We will change your seat exactly like you want it to be.

You need a Tank bag, Tear Seat Bag, Duffel Bag,
Inside Bag, Universal Bag or Tool Bag?
You can find it under **SOFT BAGS** in the catalog
and online: www.mhornig.com





R1200RT

built since 2005

1170 ccm cylinder capacity

power: 110 PS

max. torque 115 Nm

GPS Mounting 3

Made of high-quality aluminium CNC machined.
The windscreen can still be used in all positions.
For Garmin SP26**, 2720, Zumo 550, Zumo 660, Nüvi
& Garmin Quest GPS.
No drilling is required.

SP26** & 2720 owners will need to purchase the
Garmin Motorcycle Mount, available from: Global
Positioning Systems.
Garmin Quest requires Garmin Part:010-10610-00.
Allows full range of adjustment of the BMW R1200RT
screen.
Colour: Anodised Matt Black. Weight:200g

For R1200RT MY 2005 - 2009

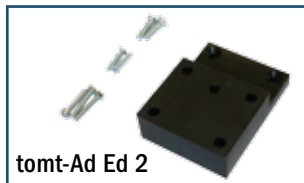

ArtNo.	Description	Price
44001	GPS Mounting 3 for the R1200RT (2005-2009)	€ 79,95
Zumo-Ad	This adapter is made for all Garmin SPIII, SP26**, 2720 & Zumo. With this adapter the GPS is 12mm closer to you and it can be dislocated 7,5mm or 15mm higher or lower as usual. You need this option for the Zumo's bus bar. Made of black Pom incl. all screws.	€ 9,95
tomtom-Ad	Adapter for TomTom Rider Incl. screws for mounting in the GPS mount and the TomTom holder.	€ 9,55
tomt-Ad Ed 2	Adapter for TomTom 2nd Edition Incl. screws for mounting in the GPS mount and the TomTom holder.	€ 14,90
ram-1zoll	Adapter for 1" Ram-Ball	€ 29,90





GPS Mounting

You can mount your GPS fast and easy with our new GPS Mount for the BMW R1200RT from MY 2010-*. The windscreen can still be used in all positions and your navigation system is always in the best possible field of vision.

Our GPS Mounts are very stable and they don't allow for vibrations.

Fits for all BMW Navigation Systems, Garmin SP111, SP26**, 2720, Zumo 550, Zumo 660, Nüvi. and X-Nav. SP26** & 2720 owners need the Garmin Motorcycle Mount (016799 or 016869).

There are 6 M4 threads but only 4 are necessary to hold any GPS firm in place.

ArtNo.	Description	Price
44011	GPS Mounting for the R1200RT (2010-*)	€ 74,90
tomtom-Ad	Adapter for TomTom Rider Incl. screws for mounting in the GPS mount and the TomTom holder.	€ 9,55
tomt-Ad Ed 2	Adapter for TomTom 2nd Edition Incl. screws for mounting in the GPS mount and the TomTom holder.	€ 14,90
ram-1zoll	Adapter for 1" Ram-Ball	€ 29,90



Bar risers

This part will raise your handlebars 25mm, creating a more comfortable riding position, while enhancing the overall handling of your bike. Longer brake line not needed when installing these bar risers.

Set consisting of the bar risers and fitting screws.

Does not fit for bikes with switches on the handle bar!

ArtNo.	Description	Price
0420	1 Set anodized	€ 82,50
0425	1 Set polished	€ 82,60
0420-1	1 Set anodized R1200RT 2010-*	€ 84,90



Sidestand foot enlargement

Feel safer parking your bike on dirt or asphalt with a side stand foot enlargement.

More than 100% bigger contact area.

Made of high quality aluminium.

Black anodized.

Easy to install.

ArtNo.	Description	Price
0710	Sidestand foot enlargement	€ 26,80

Brake pedal enlargement

This brake pedal enlargement is nicely machined of aluminium, knurled and anodized. It is quite simple to install - just slip it on and lock in place with a set-screw.

ArtNo.	Description	Price
0100	Brake pedal enlargement	€ 24,60



Axle pivot Cover

This cover for the axle pivot for all new R1200, K1200 and K1300 bikes gives a nice looking finish to the rear end and gives your motorcycle a classy look

ArtNo.	Description	Price
0072	polished	€ 21,90
0172	anodized	€ 21,90
0272	black anodized	€ 21,90



Oil filler plug with emblem

There is a drilling in the side of the plug in which you can put a size 3 Allen key or a Torx key T10 (usually found in the your BMW toolkit) in order to fit and remove it.

ArtNo.	Description	Price
0045	polished	€ 25,80
0245	anodized	€ 25,90
0246	black anodized	€ 25,95



Oil filler plug

Oil filler plug Torx, made of high-quality aluminium. Use a Torx tool T45 from your BMW tools in order to fit and remove the oil filler plug. Choose between the polished, the anodized and the black anodized version.

ArtNo.	Description	Price
0035	polished	€ 17,70
0015	anodized	€ 17,90
0016	black anodized	€ 19,90





Rear wheel centre cover

Rear wheel centre lug cover with emblem.

The holes in the covers serve for cooling!
The lower temperature is based on the special angles of the drillings, which cause a little bit more concentrated air flow, but don't be worried it doesn't affect the drivability of your BMW.

ArtNo.	Description	Price
0116	polished	€ 61,90
0216	anodized	€ 62,90
0316	black anodized	€ 63,40



Shift lever extension

Many BMW riders think that their shift lever is a little too thin and doesn't give enough grip when they're shifting. This enlarger will solve this problem for you as it offers more grip and a more sporty look for your bike. Available in polished or anodized.

ArtNo.	Description	Price
0190	polished	€ 21,40
0390	anodized	€ 21,80
0195	polished with o-rings	€ 23,50
0395	anodized with o-rings	€ 23,90
19x3	O-ring	€ 0,65

Adjustable Foot pegs

The Vario Footrest System (Joint) will be mounted to the motorcycle like the original footpeg.

The adjustable Footrest system consists of 3 parts: Vario Joint, Vario Plate and the Footrest.
All Items sold as a set for left and right.



Part 1

The Vario Footrest System (Joint) will be mounted to the motorcycle like the original footpeg. The Joint is silver anodized.



Part 2

The Vario Plate is the part between the Footpeg and the Vario Footrest System (Joint). The Vario Plate is available in 3 length. We recommend 50mm only for the pillion rider.



ArtNo.	Description	Price
051 02 01 00	Driver Vario Footrest System	€ 41,90
051 02 01 10	Pillion rider Vario Footrest System	€ 41,90
051 00 00 23	23mm Vario Plate	€ 44,50
051 00 00 30	30mm Vario Plate	€ 44,90
051 00 00 50	50mm Vario Plate (only pillion rider)	€ 45,90
050 00 04 00 8	Super Grip Footrest black	€ 51,80
050 00 04 00 1	Super Grip Footrest silver	€ 51,70
050 00 01 00 8	Racing Footrest black	€ 29,90
050 00 01 00 1	Racing Footrest silver	€ 29,95

Part 3

The Footpeg will be mounted to the Vario Plate. The Super Grip Footpegs are available in silver with black rubber.

The Racing Footpegs are available in black or silver. All Items sold as a set for left and right.

Chrome cap III

Fits for R1200RT from Bj. 10-*

The chrome cap III for the light adjustment will give your BMW another additional highlight.

The installation is as easy as effective - just stick it on with some glue like Uhu, or silicone.



ArtNo.	Description	Price
0505	Chrome cap III	€ 4,40
s2ml	Silicone 2ml	€ 0,40



Centre cap top yoke

This part is an optical improvement for your top yoke as it is made of robust aluminium with an emblem.

An integrated o-ring ensures a snug fit.

ArtNo.	Description	Price
0060	polished	€ 24,60
0260	anodized	€ 24,90
0262	black anodized	€ 23,95
0065	polished (without emblem)	€ 18,95
0265	anodized (without emblem)	€ 18,95



Synto brake- and clutch lever

Synto is the name of the 6x adjustable CNC high-precision brake and clutch made of aluminium. Combines elegance and functionality. Handling pure!

* 6 x adjustable CNC high-precision levers

* Racing proven Extremely light weight / 60g per lever

* CNC milled from high tech aeronautical norm aluminium EN 2017

* Perfect design – convincing finish

* Brilliant control feeling * Aerodynamic louver

* Levers ca. 2 cm shorter than original

* Predetermined breaking point at long version

* Adjuster colour is always black, only the black lever has a silver adjuster * For brake and clutch

* Including street homologation TÜV part certificate (ABE)



There is a video for this product online: www.mhornig.com

ArtNo.	Description	Price
BKH3-KH35-15-11-L	black-silver	€ 218,00
BKH3-KH35-17-15-L	red-black	€ 218,00
BKH3-KH35-14-15-L	blue-black	€ 218,00



Stainless steel end weight

These end weights are made of Stainless steel and create a noble look for your bike. Included are two S/S-end weights and two S/S-countersunk screws M8 for fixing.

ArtNo.	Description	Price
0451	1 Set Stainless steel end weight	€ 30,95

Crashbars ZTechnik DOHC

ZTechnik's stainless steel Engine Guards will never rust like powder coated steel guards. They are carefully designed to allow clearance for oil changes or valve cover access, so they never need to be removed. Guards attach to the engine mounts not the engine covers to protect the engine heads and not destroy them. Integrated top brackets on each guard allow the rider to mount accessory lights, video cameras, or whatever they can imagine!

BMW R1200RT 10-*



ArtNo.	Description	Price
Z7102	Crashbars ZTechnik	€ 299,00

Crashbars ZTechnik

ZTechnik's stainless steel Engine Guards will never rust like powder coated steel guards. They are carefully designed to allow clearance for oil changes or valve cover access, so they never need to be removed. Guards attach to the engine mounts not the engine covers to protect the engine heads and not destroy them. Integrated top brackets on each guard allow the rider to mount accessory lights, video cameras, or whatever they can imagine!

BMW R1200RT 05-09



ArtNo.	Description	Price
Z7101	Crashbars ZTechnik	€ 299,00



Engine cover

Made of 3mm aluminium with the latest laser-cutting and bending technology. Available in 2 versions (with/without grid) with 2 colours (natural/black anodized).

Easy and fast mounting to the original attachment points.
1 Set (for left & right side) incl. fasteners and install instructions.

Note: Not with a Crashbars combined.

Fits R1200RT 2005-2009!

ArtNo.	Description	Price
0620	1 Set anodized	€ 99,00
0621	1 Set black anodized	€ 105,00
0622	1 Set anodized with grid	€ 119,00
0623	1 Set black anodized with grid	€ 125,00



Nautilus Stebel Horn

The Nautilus Stebel Horn ensures with its 139 db that you get the necessary respect and that you won't be overlooked. Because of its E-approval mark it is street legal in the EU.

We offer also a mounting kit for the Nautilus Stebel Horn. This mounting kit consists of a stainless steel mounting fitting for your BMW R1200RT and the necessary ready-to-install wiring.

ArtNo.	Description	Price
11690120	Nautilus Stebel Horn	€ 45,00
11690120R12RT	Mounting and wiring	€ 49,00



Mirror-catch-cable

These cables are very easy to install and at the same time very effective.

They protect the cables to the indicators and ensure that they won't break, even in an accident.

You will save a lot of money as a new mirror for your bike isn't cheap.

Delivered as a set with fitting instructions.

ArtNo.	Description	Price
0600	Mirror-catch-cable 1 Set	€ 8,45

Clear Lenses

These clear lenses are sold as singles.
The brake- and rear light lens is one piece and includes the tail light and the two turn signals.
All lenses with E-mark.

ArtNo.	Description	Price
4642058	Clear indicator right	€ 42,50
4642059	Clear indicator left	€ 42,50
clhr1200rt	Tail light with clear indicator lenses	€ 132,90



Dash pad

Dash pad in carbon look - protects this very visible part of your bike from key scratches and enhances its appearance. Scratch resistant, self adhesive pad.

ArtNo.	Description	Price
80061	Dash pad	€ 6,90



Carbon Alternator cover

Extremely robust, nice cover for the alternator.
It is produced of light carbon fibre and quite easy to install.
Fits all 4V-boxer.

ArtNo.	Description	Price
110580	Alternator cover	€ 199,90





V-Stream Windshield

The „V-Stream“ Windshield set new standards for design, technology and comfort.

Made of Quantum/Lexan Polycarbonate which is 10x more scratch-resistant than usual Acrylic.

The windshield will be shipped with everything you need to mount it.

Windshield V-Stream, clear, with homologation, Height 67 cm, Width 60 cm

ArtNo.	Description	Price
115101	V-Stream Windshield	€ 219,00



Öhlins Suspension

Front:

46ER/DR:

46mm Emulsion-type shock/Monotube shock absorber.

Rebound adjuster.

Mechanical spring preload adjuster.

46 ERS/DRS:

Fits bikes where there is no room for an external reservoir.

Hose mounted hydraulic spring preload adjuster, easy to reach. Up to 10 mm adjustment range to compensate for extra luggage and/or a passenger.

Our Öhlins suspensions will be specially adjusted for you! Because of this please inform us about your weight with clothes and helmet, the weight of your luggage (perhaps pillion rider), where you ride (street, off-road, race) and how you ride (sport, touring, and so on) in the “comment” of your order.



ArtNo.	Description	Price
oehbm503	Front: Type 46ER	€ 765,00
oehbm504	Rear: Type 46DRS	€ 865,00

Sebring Twister

R 1200 RT/ST 05 model or newer Type R12T, R1ST kW 81

In 2 versions with 3 covers each

This homologated (ABE) Exhaust offers not only a perfect

Look with less Weight but also more Power and more

Torque exactly when you need it combined with a deep and throaty Sound. Pure Driving Pleasure!



ArtNo.	Description	Price
TAT4101017L	Slip-on, Twister with EG/ABE, Aluminium	€ 432,00
TTT3101017L	Exhaust System without catalytic converter, Twister with EG/ABE, Titanium	€ 1058,00



Remus HexaCone

More than 2kg lighter compared to the original exhaust.

Not only nice for the eyes but also powerful sound - the HexaCone.

Available in Stainless Steel, Carbon Fibre or Titanium.

The header has cat and because of this no EG/ABE.

R1200RT 10-*

ArtNo.	Description	Price
054682 088110L	Remus HexaCone Stainless Steel	€ 526,00
054482 088110L	Remus HexaCone Carbon Fibre	€ 603,00
054882 088110L	Remus HexaCone Titanium	€ 588,00
0101 088110	Header without cat	€ 548,00



You must send
your seat
to us!

How do you sit on your motorcycle seat? Do you want to change something in your seat?

Then read through the pages of the catalog **SEAT ALTERATION**.
We will change your seat exactly like you want it to be.

You need a Tank bag, Tear Seat Bag, Duffel Bag,
Inside Bag, Universal Bag or Tool Bag?
You can find it under **SOFT BAGS** in the catalog
and online: www.mhornig.com





www.wp-germany.com



R1200S

built since 2006

1170 ccm cylinder capacity

power: 122 PS

max. torque 112 Nm at 6800/min

Our conversion for the sportiest BMW Boxer ever takes a nod from its forerunner, the R1100S BoxerCup Replica.

For this bike we fit a specially developed GRP spoiler, useful for road and circuit, which adds to the race look.

The whole machine is repainted in Bo-xerCup colours and topped by a host of extras, all special to this model.

You will find a cooler grille, quick and easy to fit, side stand enlarger, new number plate bracket and mini indicators.

There is a new rear hugger, suitable for 180 or 190 section tyres, which works well to keep you and your bike clean.

Also of note are the adjustable footrests, white indicator lenses and a number of Aluminium parts.





GPS Mounting

Plug for BMW handlebars with inside diameter of 16mm. Just insert the CNC machined plug in the open part of the handlebar (usually closed with a plastic plug). The plug will stay in place thanks to the expansion fastener. The external diameter of the part where you mount your GPS is 22,5mm to fit almost any navigation system.

Colour: Chrome or Black

Ram-ball is also possible. Art-no.: NH 3/1

ArtNo.	Description	Price
NH 3 ch	Chrome Plug	€ 39,95
NH 3 sw	Black Plug	€ 39,95



GPS Mounting Ram Ball

Plug for BMW handlebars with inside diameter of 16mm. Just insert the CNC machined plug in the open part of the handlebar (usually closed with a plastic plug). The plug will stay in place thanks to an expansion fastener. Almost any navigation system can be fixed on the Ram-ball of this GPS Mounting.

Colour: Black

ArtNo.	Description	Price
NH 3/1	Black Plug	€ 34,95

You can find the latest products and bargains online: www.mhornig.com



Mirror Extensions HP2 Sport

Our Mirror Extensions are the perfect solutions when you see mainly your shoulders in the rear mirrors. The mirrors will be moved some centimeters out from each other in order to improve the view to the back.

ArtNo.	Description	Price
BK 09	1 Set Mirror Extensions for HP2 Sport	€ 49,95

Shift lever extension

Many BMW riders think that their shift lever is a little too thin and doesn't give enough grip when they're shifting.

This enlarger will solve this problem for you as it offers more grip and a more sporty look for your bike. Available in polished or anodized.

ArtNo.	Description	Price
0190	polished	€ 21,40
0390	anodized	€ 21,80
0195	polished with o-rings	€ 23,50
0395	anodized with o-rings	€ 23,90
19x3	O-ring	€ 0,65



Rear wheel centre cover

Rear wheel centre lug cover with emblem.

The holes in the covers serve for cooling! The lower temperature is based on the special angles of the drillings, which cause a little bit more concentrated air flow, but don't be worried it doesn't affect the drivability of your BMW.

ArtNo.	Description	Price
0116	polished	€ 61,90
0216	anodized	€ 62,90
0316	black anodized	€ 63,40





Axle pivot Cover

This cover for the axle pivot for all new R1200, K1200 and K1300 bikes gives a nice looking finish to the rear end and gives your motorcycle a classy look.

ArtNo.	Description	Price
0072	polished	€ 21,90
0172	anodized	€ 21,90
0272	black anodized	€ 21,90



Telelever end caps

Aluminium cap, natural anodized or polished.
We send the caps in a set (2 parts).

ArtNo.	Description	Price
0095	1 Set polished	€ 29,80
0295	1 Set silver anodized	€ 29,90
0296	1 Set black anodized	€ 29,95



Bar-end weights

These bar-end weights made of Stainless steel or aluminium show that BMW riders are aware of function and form.

Article number: 0805 stainless steel 220 gram each

Article number: 0806 aluminium 84 gram each

Shipment: 2 end weights, 2 screws.

ArtNo.	Description	Price
0805	1 Set Stainless steel	€ 32,90
0806	1 Set Aluminium anodized	€ 25,90



Cover

Covers for the fluid reservoirs.

You simply stick them onto the fluid reservoirs. Can be removed them without residue.

Made of high quality aluminium.

They are sold in a set of two.

ArtNo.	Description	Price
0700	1 Set polished	€ 39,80
0701	1 Set anodized	€ 39,90
0702	1 Set black anodized	€ 39,95
s2ml	Silicone 2ml	€ 0,40

Engine cover

Made of 3mm aluminium with the latest laser-cutting and bending technology. Available in 2 versions (with/without grid) with 2 colours (natural/black anodized). Easy and fast mounting to the original attachment points.

1 Set (for left & right side) incl. fasteners and install instructions.

Note: Not with a Crashbars combined.

ArtNo.	Description	Price
0620	1 Set anodized	€ 99,00
0621	1 Set black anodized	€ 105,00
0622	1 Set anodized with grid	€ 119,00
0623	1 Set black anodized with grid	€ 125,00



Synto brake- and clutch lever

Synto is the name of the 6x adjustable CNC high-precision brake and clutch made of aluminium.

Combines elegance and functionality. Handling pure!

* 6 x adjustable CNC high-precision levers

* Racing proven Extremely light weight / 60g per lever

* CNC milled from high tech aeronautical norm aluminium EN 2017

* Perfect design - convincing finish

* Brilliant control feeling * Aerodynamic louver

* Levers ca. 2 cm shorter than original

* Predetermined breaking point at long version

* Adjuster colour is always black, only the black lever has a silver adjuster * For brake and clutch

* Including street homologation TÜV part certificate (ABE)
There is a video for this product online: www.mhornig.com

ArtNo.	Description	Price
BH27-BKH1-15-11-L	black-silver	€ 218,00
BH27-BKH1-17-15-L	red-black	€ 218,00
BH27-BKH1-14-15-L	blue-black	€ 218,00



Sidestand foot enlargement

Feel safer parking your bike on dirt or asphalt with a side stand foot enlargement.

More than 100% bigger contact area.

Made of high quality aluminium.

Black anodized.

Easy to install.

ArtNo.	Description	Price
0720	Sidestand foot enlargement	€ 24,90





Oil filler plug with emblem

There is a drilling in the side of the plug in which you can put a size 3 Allen key or a Torx key T10 (usually found in the your BMW toolkit) in order to fit and remove it.

ArtNo.	Description	Price
0045	polished	€ 25,80
0245	anodized	€ 25,90
0246	black anodized	€ 25,95



Oil filler plug

Oil filler plug Torx, made of high-quality aluminium.

Use a Torx tool T45 from your BMW tools in order to fit and remove the oil filler plug.

Choose between the polished, the anodized and the black anodized version.

ArtNo.	Description	Price
0035	polished	€ 17,70
0015	anodized	€ 17,90
0016	black anodized	€ 19,90



Swing arm pivot cover left

This cover is the perfect replacement for the original plastic cap.

Made of aluminium

ArtNo.	Description	Price
0-4-14	polished	€ 15,90
0-4-15	anodized	€ 16,40
0-4-16	black anodized	€ 16,70



Swing arm pivot cover right

This cover is the perfect replacement for the original plastic cap.

Made of aluminium.

ArtNo.	Description	Price
0-4-39	polished	€ 15,90
0-4-37	anodized	€ 16,50
0-4-38	black anodized	€ 16,60

Speedometer cover

In order to customize your BMW R1200S's speedo. Made of milled or laser cutted aluminium, polished or anodized.

Very easy to mount with usual silicon. An install instruction is included in the set for the speedo and the revolution counter.

ArtNo.	Description	Price
0411	1 Set polished	€ 74,90
0411-1	1 Set anodized	€ 74,95
s10ml	Silicone 10ml	€ 0,80



Frame cover

This cover for the open hole beyond the swing arm pivot is made of aluminium and available in different versions.

It gets fixed on the right side.

ArtNo.	Description	Price
0340	polished	€ 12,25
0440	anodized	€ 12,50
0441	black anodized	€ 12,60



Foot brake fluid reservoir cover

Cover for the foot brake fluid reservoir CNC machined of aluminium. polished.

Image shows K1200R.

But it is also visible on: R1200S.

ArtNo.	Description	Price
0706	polished	€ 19,90
0706-1	anodized	€ 20,90
s2ml	Silicone 2ml	€ 0,40



Superbike Handlebar

Sporty riding without carrying your whole weight on your lower arms is the dream of many riders. To meet this wish,

a Superbike handlebar conversion has been developed which with its tapered handlebars and full black anodizing not only looks sophisticated but also ensures sporting performance with very little strain on the rider.

The Superbike handlebar conversion includes all components necessary for fitting.

ArtNo.	Description	Price
50120640406	Superbike Handlebar	€ 419,00





Adjustable Foot pegs

The Vario Footrest System (Joint) will be mounted to the motorcycle like the original footpeg.

The adjustable Footrest system consists of 3 parts: Vario Joint, Vario Plate and the Footrest. All Items sold as a set for left and right.



Part 1

The Vario Footrest System (Joint) will be mounted to the motorcycle like the original footpeg. The Joint is silver anodized.



Part 2

The Vario Plate is the part between the Footpeg and the Vario Footrest System (Joint). The Vario Plate is available in 3 length. We recommend 50mm only for the pillion rider.



ArtNo.	Description	Price
051 02 03 00	Driver Vario Footrest System	€ 41,90
051 02 03 10	Pillion rider Vario Footrest System	€ 41,90
051 00 00 23	23mm Vario Plate	€ 44,50
051 00 00 30	30mm Vario Plate	€ 44,90
051 00 00 50	50mm Vario Plate (only pillion rider)	€ 45,90
050 00 04 00 8	Super Grip Footrest black	€ 51,80
050 00 04 00 1	Super Grip Footrest silver	€ 51,70
050 00 01 00 8	Racing Footrest black	€ 29,90
050 00 01 00 1	Racing Footrest silver	€ 29,95

Part 3

The Footpeg will be mounted to the Vario Plate.

The Super Grip Footpegs are available in silver with black rubber.

The Racing Footpegs are available in black or silver.

All Items sold as a set for left and right.

Oil cooler screen

This anodized aluminium screens protect the oil cooler from stones, flies and other debris. It is very easy to install and gives your R1200S an even more sporty appearance.

If you have no silicone you can also order our high quality silicone which is pre-filled in the volume you need and easy to dose.

ArtNo.	Description	Price
0606	Oil cooler screen	€ 24,90
s10ml	Silicone 10ml	€ 0,80



Number plate mounting

Our very light and shapely number plate mounting is made of aluminium and either black or natural coating. Incl. pre-assembled number plate light, adapter plate, small, colour-coordinated LED turning signals and a reflector which can be left off.

ArtNo.	Description	Price
33001	Natural aluminium alloy	€ 264,80
33002	Black aluminium alloy	€ 264,80



You can find Front- and Back lifter
for the R1200S online:
www.mhornig.com



Clear lenses

Clear or grey lenses for the front indicator indicators with 2 orange bulbs. For R1200S.

Replacement bulb with orange coating 12V/16W.

NEW! With European approval mark

ArtNo.	Description	Price
400.10.20w	1 Set clear lenses	€ 69,90
400.10.20g	1 Set grey lenses	€ 69,90



LED turning signals

Awesome brightness, fitted in seconds and including electronics on the back of the panel to ensure the correct flash rate. It is the complete turning signal and has a homologation. So it is the first road legal LED for BMW bikes! The LEDs flash yellow.

Sold in pairs (for left and right).

ArtNo.	Description	Price
01006	1 pair of LED turning signals with clear lenses	€ 89,95
01006-g	1 pair of LED turning signals with grey lenses	€ 89,95



Clear indicator lens

Clear indicator lenses. Sold in a set (2 pieces).

And if you want, also single.

With E-Mark, so they are homologated for the EU.

Shipping: 2 lenses incl. orange bulbs.

ArtNo.	Description	Price
CTS-0037	Clear indicator lens	€ 20,90
CTS-0037-g	Grey indicator lens	€ 20,95



Indicator bulb

Either orange or special coated. The special coated one only lights orange when you use the indicator (usually used with transparent lenses). Single.

ArtNo.	Description	Price
BLWB-CBUS	orange 12V/10W	€ 2,55
BLWBT-CBUS	special coated 12V/10W	€ 5,99
10031086	orange coated 12V/16W only front	€ 4,15
WLG-194	chrome colour 12V/16W only front	€ 7,90

Racingscreen

The racing screen has basically the same shape like the original one but a little increase in the middle to reduce the wind pressure on the helmet.

With ABE, length 375 mm.

ArtNo.	Description	Price
R-R1200S-k	clear	€ 79,90
R-R1200S-rg	smoke grey	€ 79,90
R-R1200S-s	black	€ 79,90



Touringscreen

The touring shield has the same shape as the original, but with an additional raised wind deflector at the rear, which covers the entire width. This deflects the wind over the rider and facilitates a relaxed drive, particularly on longer trips.

longer trips.

With ABE, length 410 mm.

ArtNo.	Description	Price
T-R1200S-k	clear	€ 79,90
T-R1200S-rg	smoke grey	€ 79,90
T-R1200S-s	black	€ 79,90





Rear Hugger

Fits between the rear shock and wheel and extends rearwards to end near the end of the exhaust. Designed specifically keep road debris and water from the backs of riders/passengers legs, shock, gearbox, battery and so on. It can be painted in any colour you like and fits 180 and 190 tyres.

ArtNo.	Description	Price
40095	Rear Hugger black primed	€ 199,90



Engine spoiler

Made of high quality fibre-glass reinforced synthetic material and primed or manufactured of carbon fibre. Easy to install. Incl. all fasteners and install instructions.

If you have no silicone you can also order our high quality silicone which is pre-filled in the volume you need and easy to dose.

ArtNo.	Description	Price
40110	GRP Engine spoiler	€ 398,00
40111	Grille	€ 19,00
s10ml	Silicone 10ml (you need it 2x)	€ 0,80



Dash pad

Carbon look - protects this very visible part of your bike from your keys and enhances its appearance with this scratch resistant, self adhesive pad.

ArtNo.	Description	Price
80082	Dash pad	€ 10,30



Carbon Alternator cover

Extremely robust, nice cover for the alternator. It is produced of light carbon fibre and quite easy to install. Fits all 4V-boxer.

ArtNo.	Description	Price
110580	Alternator cover	€ 199,90



Carbon Reservoir-Cover Kit

Cover Kit for reservoirs of brake and clutch fluid reservoirs with carbon surface. The carbon fibre parts are precisely shaped and are to be fitted by glue.

ArtNo.	Description	Price
400.10.40	1 Set Reservoir-Covers	€ 59,00
s2ml	Silicone 2ml	€ 0,40



Carbon Brake line cover

This cover protects the brake line of your R1200S (all MYS) in the best possible and the best looking way.

ArtNo.	Description	Price
110680	Brake line cover	€ 99,90





ABS resin mud guard

This solid rear hugger is made of ABS resin plastics and provides perfect protection for your suspension, your exhaust, your header and for the whole rear part of your bike. Not to forget your pillion rider! Everything you need to install it is included. With ABE (European homologation).

ArtNo.	Description	Price
5861N	ABS resin mud guard	€ 184,00



Carbon Tank Centre Panel

This cover for the middle part of the tank is made of carbon fibre which looks very sporty but it quite resistant to scratching.

ArtNo.	Description	Price
TAO.004.R120S.K	Tank Centre Panel	€ 299,90



Carbon Engine spoiler

Made of high quality carbon fibre. Easy to install. Incl. all fasteners and install instructions.

ArtNo.	Description	Price
VEU.010.R120S.K	Engine spoiler	€ 849,90



Carbon Rear mudguard

Provides ultimate protection for the rear shock absorber! Spend less time in cleaning - more time riding! The best fit possible is provided by an aluminium fastener: fits BMW HP2 Sport.

ArtNo.	Description	Price
KHO.001.HP2SPK	Rear mudguard	€ 269,90



Carbon Rear mudguard

Provides ultimate protection for the rear shock absorber!
Spend less time in cleaning - more time riding!

The best fit possible is provided by an aluminium fastener: fits 180 and 190 rear tyre and can be used with and without ESA.



ArtNo.	Description	Price
KHO.001.R120S.K	Rear mudguard	€ 269,90

Carbon Front Mudguard

Made of nice looking and high-quality carbon fibre.
It is very light and makes a brilliant looking addition to your bike.



ArtNo.	Description	Price
KVO.012.R120S.K	Front Mudguard	€ 229,90

WP suspension front & rear

Our WP suspensions will be specially adjusted for you! Because of this please inform us about your weight with clothes and helmet, the weight of your luggage (perhaps pillion rider), where you ride (street, off-road, race) and how you ride (sport, touring, and so on) in the „comment“ of your order.

The Spin as well as the Emulsion suspension can be combined with the hydraulic preload adjustment. (productnr. /02)

You can choose any spring colour you like.

High/Low speed compression separately adjustable, each 16 times (256 possibilities) (only Spin and Fusion)

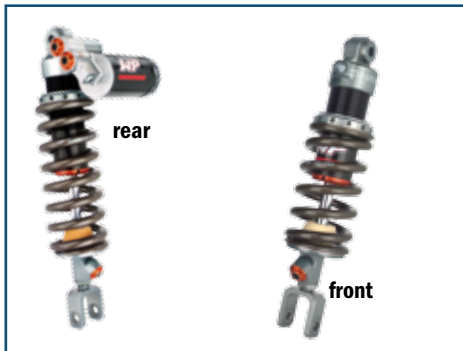

Suspension rear: adjustable rebound preload adjuster

Suspension front: preload adjuster, 16 positions.

For riders wanting the upmost from their machine Exceptional cooling properties due to the use of heat diverting aluminium alloys, therefore constant shock absorption and longer life

Lightweight through use of high quality materials
Adjustable length is standard
Recognised safety certificate

ArtNo.	Description	Price
17.06.7B.84	Spin suspension with fixed reservoir rear	€ 899,00
17.06.9B.84	Emulsion suspension rear	€ 549,00
/02	Hydraulic preload adjustment	€ 229,00
17.06.7B.85	Spin suspension with fixed reservoir front	€ 899,00
17.06.9B.85	Emulsion suspension front	€ 549,00



How do you sit on your motorcycle seat? Do you want to change something in your seat?

Then read through the pages of the catalog **SEAT ALTERATION**.

We will change your seat exactly like you want it to be.

**You must send
your seat
to us!**

You need a Tank bag, Tear Seat Bag, Duffel Bag,
Inside Bag, Universal Bag or Tool Bag?
You can find it under SOFT BAGS in the catalog
and online: www.mhornig.com



R 1200 ST



R1200ST

R1200ST

built since 2005

1170 ccm cylinder catalytic

power: 81/110 PS

max. torque 115 Nm

GPS Mounting

Bolt + Ram-Ball with M10 thread. CNC machined for TomTom Rider 2 and Garmin Zumo. You can mount all Ram-Mounts on the Ram-Ball.

Colour: Black

Can just be mounted with the Mirror Extensions BK 02 as you see in the picture.

ArtNo.	Description	Price
NH 1/6	GPS Mounting black	€ 24,95
BK 02	Mirror Extension 1 Set	€ 49,95



Rear wheel centre cover

Rear wheel centre lug cover with emblem.

The holes in the covers serve for cooling! The lower temperature is based on the special angles of the drillings, which cause a little big more concentrated air flow, but don't be worried it doesn't affect the drivability of your BMW.

ArtNo.	Description	Price
0116	polished	€ 61,90
0216	anodized	€ 62,90
0316	black anodized	€ 63,40



Frame cover

This cover for the open hole beyond the swing arm pivot is made of aluminium and available in different versions. It gets fixed on the right side.

ArtNo.	Description	Price
0340	polished	€ 12,25
0440	anodized	€ 12,50
0441	black anodized	€ 12,60





Oil filler plug with emblem

There is a drilling in the side of the plug in which you can put a size 3 Allen key or a Torx key T10 (usually found in the your BMW toolkit) in order to fit and remove it.

ArtNo.	Description	Price
0045	polished	€ 25,80
0245	anodized	€ 25,90
0246	black anodized	€ 25,95



Oil filler plug

Oil filler plug, made of high-quality aluminium.

Use a Torx tool T45 from your BMW tools in order to fit and remove the oil filler plug.

Choose between the polished, the anodized and the black anodized version.

ArtNo.	Description	Price
0035	polished	€ 17,70
0015	anodized	€ 17,90
0016	black anodized	€ 19,90



Swing arm pivot cover left

This cover is the perfect replacement for the original plastic cap.

Made of aluminium.

ArtNo.	Description	Price
0-4-14	polished	€ 15,90
0-4-15	anodized	€ 16,40
0-4-16	black anodized	€ 16,70



Swing arm pivot cover right

This cover is the perfect replacement for the original plastic cap.

Made of aluminium.

ArtNo.	Description	Price
0-4-39	polished	€ 15,90
0-4-37	anodized	€ 16,50
0-4-38	black anodized	€ 16,60

Speedometer cover

In order to customize your BMW R1200ST's speedo.
Made of milled or laser cutted aluminium, polished or anodized. Very easy to mount with usual silicon.
An install instruction is included in the set for the speedo and the revolution counter.

ArtNo.	Description	Price
0411	1 Set polished	€ 74,90
0411-1	1 Set anodized	€ 74,95
s10ml	Silicone 10ml	€ 0,80



Foot brake fluid reservoir cover

Cover for the foot brake fluid reservoir CNC machined of aluminium. polished.
Image shows K1200R.
But it is also visible on: R1200ST.

ArtNo.	Description	Price
0706	polished	€ 19,90
0706-1	anodized	€ 20,90
s2ml	Silicone 2ml	€ 0,40



Superbike handlebars

These handlebars create a new sporty look and improve the handling of the bike.
The mounting kit is made of high quality aluminium and the bars are especially designed for the R1200ST.
The handlebar is 70mm closer and 100mm higher.

ArtNo.	Description	Price
AC-R1200ST	Superbike handlebars	€ 399,00



Centre cap top yoke

Made of aluminium with emblem;
Fitting instructions included.
If you have no silicone at you can also order our high quality silicone which is pre-filled in the volume you need and easy to dose.

ArtNo.	Description	Price
0083	polished	€ 19,90
0283	anodized	€ 19,95
s10ml	Silicone 10ml	€ 0,80





Shift lever extension

Many BMW riders think that their shift lever is a little too thin and doesn't give enough grip when they're shifting. This enlarger will solve this problem for you as it offers more grip and a more sporty look for your bike. Available in polished or anodized.

ArtNo.	Description	Price
0190	polished	€ 21,40
0390	anodized	€ 21,80
0195	polished with o-rings	€ 23,50
0395	anodized with o-rings	€ 23,90
19x3	O-ring	€ 0,65



Axle pivot Cover

This cover for the axle pivot for all new R1200, K1200 and K1300 bikes gives a nice looking finish to the rear end and gives your motorcycle a classy look.

ArtNo.	Description	Price
0072	polished	€ 21,90
0172	anodized	€ 21,90
0272	black anodized	€ 21,90



Brake pedal enlargement

Nicely machined aluminium, knurled and natural anodized.

This enlargement simply slips on and is held in place with a set-screw.

ArtNo.	Description	Price
0180	anodized	€ 22,15



Engine cover

Made of 3mm aluminium with the latest laser-cutting and bending technology. Available in 2 versions (with/without grid) with 2 colours (natural/black anodized). Easy and fast mounting to the original attachment points.

1 Set (for left & right side) incl. fasteners and install instructions.

Note: Not with a Crashbars combined.

ArtNo.	Description	Price
0620	1 Set anodized	€ 99,00
0621	1 Set black anodized	€ 105,00
0622	1 Set anodized with grid	€ 119,00
0623	1 Set black anodized with grid	€ 125,00



Mirror Extensions

Our Mirror Extensions are the perfect solutions. if you see mainly your shoulders in the mirrors. The mirrors will be moved a few centimetres out in order to improve the view to the rear.

ArtNo.	Description	Price
BK 02	Mirror Extensions 1 Set (M10)	€ 49,95



Synto brake- and clutch lever

Synto is the name of the 6x adjustable CNC high-precision brake and clutch made of aluminium.

Combines elegance and functionality. Handling pure!

* 6 x adjustable CNC high-precision levers

* Racing proven Extremely light weight / 60g per lever

* CNC milled from high tech aeronautical norm aluminium EN 2017

* Perfect design – convincing finish

* Brilliant control feeling * Aerodynamic louver

* Levers ca. 2 cm shorter than original

* Predetermined breaking point at long version

* Adjuster colour is always black, only the black lever has a silver adjuster * For brake and clutch

* Including street homologation TÜV part certificate (ABE)

There is a video for this product online: www.mhornig.com

ArtNo.	Description	Price
BH27-BKH1-15-11-L	black-silver	€ 218,00
BH27-BKH1-17-15-L	red-black	€ 218,00
BH27-BKH1-14-15-L	blue-black	€ 218,00



Adjustable Foot pegs

The Vario Footrest System (Joint) will be mounted to the motorcycle like the original footpeg.

The adjustable Footrest system consists of 3 parts: Vario Joint, Vario Plate and the Footrest. All Items sold as a set for left and right.



Part 1

The Vario Footrest System (Joint) will be mounted to the motorcycle like the original footpeg. The Joint is silver anodized.



Part 2

The Vario Plate is the part between the Footpeg and the Vario Footrest System (Joint). The Vario Plate is available in 3 length. We recommend 50mm only for the pillion rider.



ArtNo.	Description	Price
051 02 03 00	Driver Vario Footrest System	€ 41,90
051 02 03 10	Pillion rider Vario Footrest System	€ 41,90
051 00 00 23	23mm Vario Plate	€ 44,50
051 00 00 30	30mm Vario Plate	€ 44,90
051 00 00 50	50mm Vario Plate (only pillion rider)	€ 45,90
050 00 04 00 8	Super Grip Footrest black	€ 51,80
050 00 04 00 1	Super Grip Footrest silver	€ 51,70
050 00 01 00 8	Racing Footrest black	€ 29,90
050 00 01 00 1	Racing Footrest silver	€ 29,95

Part 3

The Footpeg will be mounted to the Vario Plate. The Super Grip Footpegs are available in silver with black rubber.

The Racing Footpegs are available in black or silver. All Items sold as a set for left and right.

Sidestand foot enlargement

Feel safer parking your bike on dirt or asphalt with a side stand foot enlargement.

More than 100% bigger contact area.
Made of high quality aluminium.
Black anodized.
Easy to install.

ArtNo.	Description	Price
0710	Sidestand foot enlargement	€ 26,80



Front lifter

Our front lifter fits BMW R1200ST.
It is perfect for care, overwinter and servicing.
Made of steel 35x35mm, zinc-plated and quality
„Made in Germany“.

ArtNo.	Description	Price
2039-80	Front lifter	€ 99,90



Back lifter

Slide the rubber coated pipe of the Back lifter in the
final drive of your BMW and lift it up. Easy to use by one
person and very stable support for the bike.
Made of high quality steel. Diameter 42mm, zinc-plated.
The diameter of the rubber is 52,5mm.

ArtNo.	Description	Price
BT.heck-lifter	Back lifter	€ 89,90



Crashbars ZTechnik

ZTechnik's stainless steel Engine Guards will never rust
like powder coated steel guards. They are carefully
designed to allow clearance for oil changes or valve cover
access, so they never need to be removed. Guards attach
to the engine mounts not the engine covers to protect the
engine heads and not destroy them. Integrated top bra-
ckets on each guard allow the rider to mount accessory
lights, video cameras, or whatever they can imagine!



ArtNo.	Description	Price
Z7101	Crashbars ZTechnik	€ 299,00



V-Stream Windshield

The „V-Stream“ Windshield set new standards for design, technology and comfort. Made of Quantum/Lexan Polycarbonate which is 10x more scratch-resistant than usual Acrylic. The windscreen will be shipped with everything you need to mount it. With original handlebar are mirror extensions BK 02 required.

Windshield V-Stream, with homologation

ArtNo.	Description	Price
115103	clear, Height 31cm, Width 49cm	€ 179,00
Z2202	black, like original screen	€ 149,00



Indicator bulb

Either orange or special coated. The special coated one only lights orange when you use the indicator (usually used with transparent lenses).

Your R1200ST use front 12V/21W and rear 12V/10W. 1 piece.

ArtNo.	Description	Price
BLWB	orange 12V/21W front	€ 2,45
BLWBT	special coated bulb 12V/21W front	€ 9,90
BLWB-CBUS	orange 12V/10W rear	€ 2,55
BLWBT-CBUS	special coated bulb 12V/10W rear	€ 5,99



Sebring Twister

R 1200 RT/ST 05 model or newer Type R12T, R1ST kW 81 In 2 versions with 3 covers each

This homologated (ABE) Exhaust offers not only a perfect Look with less Weight but also more Power and more Torque exactly when you need it combined with a deep and throaty Sound. Pure Driving Pleasure!

ArtNo.	Description	Price
TAT4101017L	Slip-on, Twister with EG/ABE, Aluminium	€ 432,00
TTT3101017L	Exhaust System without catalytic converter, Twister with EG/ABE, Titanium	€ 1058,00

Dash pad

Carbon look - protects this very visible part of your bike from your keys and enhances it's appearance with this scratch resistant, self adhesive pad.

ArtNo.	Description	Price
80062	Dash pad	€ 13,50



Carbon Reservoir-Cover Kit

Cover Kit for reservoirs of brake and clutch fluid reservoirs with carbon surface. The carbon fibre parts are precisely shaped and are to be fitted by glue.

ArtNo.	Description	Price
400.10.40	1 Set Reservoir-Covers	€ 59,00
s2ml	Silicone 2ml	€ 0,40



Carbon Alternator cover

Extremely robust, nice cover for the alternator. It is produced of light carbon fibre and quite easy to install. Fits all 4V-boxer.

ArtNo.	Description	Price
110580	Alternator cover	€ 199,90



You can find
more exhausts
from Laser, Sebring und BOS
online:
www.mhornig.com





You must send
your seat
to us!

How do you sit on your motorcycle seat? Do you want to change something in your seat?

Then read through the pages of the catalog **SEAT ALTERATION**.

We will change your seat exactly like you want it to be.

You need a Tank bag, Tear Seat Bag, Duffel Bag,
Inside Bag, Universal Bag or Tool Bag?
You can find it under **SOFT BAGS** in the catalog
and online: www.mhornig.com



Freiheit und Abenteuer für reisefreudige Motorradfahrer

www.reisemotorrad.de



Am Kiosk erhältlich oder versandkostenfrei
bestellbar unter www.szeneshop.com

Szene Shop.COM



S1000RR

built since 2010

999 ccm cylinder capacity

power: 193 PS

max. torque 112 Nm at 9.750 U/min

Superbike Handlebar

Sporty riding without carrying your whole weight on your lower arms is the dream of many riders. To meet this wish, a Superbike handlebar conversion has been developed which with its tapered handlebars and full black anodizing not only looks sophisticated but also ensures sporting performance with very little strain on the rider.

The Superbike handlebar fits all bikes with ABS. If your bike has no ABS you need to order the brake line kit. The brake fluid reservoir on the pictures doesn't belong to the shipment. The Superbike handlebar conversion includes all components necessary for fitting.

ArtNo.	Description	Price
S50101040406	Superbike Handlebar	€ 699,00
bl-kit	Brake Line Kit	€ 99,00
S423-10328-15	Brake Fluid Reservoir	€ 64,90



Registration Plate Holder

A better view of the rear wheel is possible thanks to the stable stainless steel registration plate holder which bolts onto the standard support. Without registration, it fulfils all requirements for legal fitment and can be used both with standard flashers and most accessory components.

ArtNo.	Description	Price
S426-67168-15	Registration Plate Holder	€ 139,00



Synto brake- and clutch lever

Synto is the name of the 6x adjustable CNC high-precision brake and clutch made of aluminium.

Combines elegance and functionality. Handling pure!

* 6 x adjustable CNC high-precision levers

* Racing proven Extremely light weight / 60g per lever

* CNC milled from high tech aeronautical norm aluminium EN 2017

* Perfect design – convincing finish

* Brilliant control feeling * Aerodynamic louver

* Levers ca. 2 cm shorter than original

* Predetermined breaking point at long version

* Adjuster colour is always black, only the black lever has a silver adjuster * For brake and clutch

* Including street homologation TÜV part certificate (ABE)

ArtNo.	Description	Price
BH29-KH39-15-11-L	black-silver	€ 218,00
BH29-KH39-17-15-L	red-black	€ 218,00
BH29-KH39-14-15-L	blue-black	€ 218,00





Footrest System

This GP Footrest System is incl. TUV certificate - original micro switch and heel guards to be continued to use. The article numbers FXR-BM01-* are with usual shifting and the article numbers FXR-BM01-P-* are with gp-shifting. „P“ version: lower fairing needs a cut out and only in connection with BMW quick shifter otherwise the separate gear shaft kit needs to be ordered.

There is a video for this product online: www.mhornig.com

ArtNo.	Description	Price
FXR-BM01-N	aluminium raw	€ 339,00
FXR-BM01-B	aluminium black anodized	€ 379,00
FXR-BM01-P-N	with gp shift aluminium raw	€ 359,00
FXR-BM01-P-B	with gp shift black anodized	€ 399,00
USW-Kit	Gear Shaft Kit	€ 49,90



Reverse Shifting Kit

With this kit you can change your shifting easy into the reverse shifting or also called GP-Shifting. The kit can be used with the original shifting system but also with the BMW HP shifting system.

lower fairing needs a cut out - only in conjunction with BMW quick shifter - otherwise you need to order the gear shaft kit, too.

ArtNo.	Description	Price
US-21-K46-N	aluminium raw	€ 124,00
US-21-K46-B	black	€ 129,00
USW-Kit	Gear Shaft Kit	€ 49,90



Oil Filler Plug

This Oil Filler Plug is made of high quality aluminium and available in three colours: black anodized, silver anodized or polished. You can open this Oil Filler Plug with a Torx T45.

ArtNo.	Description	Price
0025	black anodized	€ 18,50
0024	silver anodized	€ 18,30
0023	high polished	€ 18,00

Fork Adjuster

This fork adjuster is made of CNC milled aluminium and is used of fast and simple adjusting of the spring preload and it is the new highlight on our BMW S1000RR.

The scaling is added to the aluminium part with a laser and makes it possible to adjust both sides very precise!

Colours: gold, black, blue and red

Weight: 22g

One Set for left and right

ArtNo.	Description	Price
216-15459-15	1 Set black	€ 29,90
216-15459-17	1 Set red	€ 29,90
216-15459-14	1 Set blue	€ 29,90
216-15459-12	1 Set gold	€ 29,90



CNC milled fluid reservoir

The CNC milled fluid reservoir is available with a 90° outlet in silver, black and gold.

The reservoir capacity is 22 ml and the glass in it is real Jenaglas.

A holder set for BMW S1000R is supplied with the reservoir.

The weight is 64 gram.

ArtNo.	Description	Price
423-10328-15	black	€ 59,90
423-10328-11	silver	€ 59,90
423-10328-12	gold	€ 59,90



Crashpad

The crash cap is made of special plastic for best sliding characteristics. The design pad does not only look good but also provides maximal protection for the rider, frame and engine of your BMW S1000RR because of its patented impact inlay. This protection can't be provided by any other crashpad!

ArtNo.	Description	Price
IP-BM06-B	Crashpad	€ 129,00





Mirror Extensions

Our Mirror Extensions per 30mm are the perfect solutions if you see mainly your shoulders in the mirrors.

The mirrors will be moved a few centimetres out in order to improve the view to the rear.

ArtNo.	Description	Price
BKB 03	Mirror Extensions 1 Set	€ 49,90



Mirror Caps

Add a sleek look to your bike with Hornig Mirror Caps. Made of POM (synthetic material and extreme light), these lightweight mirror caps fill the gap left when removing mirrors during race prep. They will be delivered with everything you need in order to install them.

1 Set (left and right)

ArtNo.	Description	Price
0335	Mirror Caps 1 Set	€ 24,50

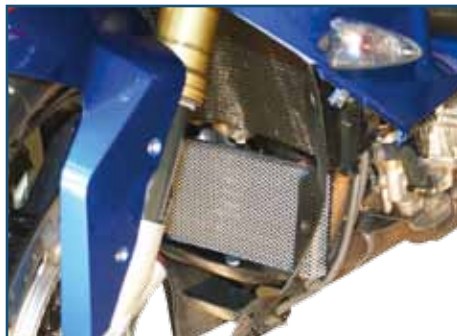

Cooler screen

Perfect protection for your oil cooler which looks quite nice and is designed of high-quality aluminium and covered with a special protective aluminium alloy. Install instruction is included.

When you have no silicone at home you can also order our highquality silicone which is already filled in the volume you need and easy to dose.

ArtNo.	Description	Price
0608	Cooler screen silver	€ 28,00
s10ml	Silicone 10ml	€ 0,80

Fork Lift Stand / Rear Stand

The Fork Lift Stand and the Rear Stand are perfect for care, overwinter and servicing. It is made of solid steel 35x35mm, galvanized and quality „Made in Germany“.

A huge advantage of this stand is that you can change the height.

4 large solid wheels provide the necessary stability.

[There is a video for this product online!](#)



ArtNo.	Description	Price
2039-80	Fork Lift Stand	€ 99,90
2039-52	Rear Stand	€ 99,90

Strap Holder

This strap holder is milled of aluminium, bent, black anodized and you mount it instead of the pillion rider's pegs. We developed this strap holder in order to fix our Race-S1000RR easy and fast in our truck but you can of course also mount your luggage.

One set for left and right.



ArtNo.	Description	Price
0285	1 Set Strap Holder	€ 49,00





Race Track Sticker

These stickers for the race track are made of high quality black film which is also UV resistant and they are specially made for your BMW S1000RR. Glue them on and you are ready for the race track, almost no work and no errors. Available for the front lights and the turning signals.

ArtNo.	Description	Price
aufk-s1000rr-front	Stickers Lights	€ 11,90
aufk-s1000rr-blinker	Stickers Turning Signals (4x)	€ 9,90



Racingscreen

This Racingscreen for the BMW S1000RR is 7cm longer and 3 cm higher as the original screen. The total length is 43cm. This screen was successfully used in the SBK World Championship 2009.

ArtNo.	Description	Price
4025066123810	clear	€ 79,90
4025066123827	smoke grey	€ 79,90
4025066123841	black	€ 79,90
4025066123834	blue	€ 79,90



GPS Mount

Just screw this GPS Mount on to the dash. There is already the necessary thread. Almost any navigation system can now be fixed on the Ram-ball (1") of this GPS Mounting.

ArtNo.	Description	Price
NH 3/1 15mm	GPS Mount	€ 34,95

ATTENTION !!! For all who use their S1000RR on the race track.
 You can find online in our web shop: www.mhornig.com
 GRP Race Fairings and much more

Crash-Pads Slider

Our Crash-Pads or Sliders protect your frame, engine and fairing of your motorcycle. This crash pad is designed to fit perfect to your motorcycle. It is made of high-strength milled aluminium and high-strength POM plastic. All our pads are screwed to your motorcycle at least at 2-3 points. The advantage over round crash pads is that these slider can't break or snag on something on the road.
 Shipment: Crash Pads for the left and right side with mounting.



ArtNo.	Description	Price
RLBM01-S1000RR	Crash-Pads Slider	€ 279,90

Engine-Crash-Pads

These engine crash-pads for the left and right side provide extra protection for your motorcycle. The crash-pads are made of milled state-of-the-art POM plastic which is high-strength.
 Shipping includes crash pads for the left and right side plus mounting.



ArtNo.	Description	Price
SCBM01	Engine-Crash-Pads	€ 115,00

Front and Rear Crash-Pads

These crash-pads for the front and rear part of your motorcycle are CNC lathed. They are made of high quality POM plastic. The mounting is made of aluminum and anodized. The crash pads provide extra protection and reduce damage to your motorcycle.
 Shipment includes both pads and mounting.



ArtNo.	Description	Price
PRBM01	Front and Rear Crash-Pads	€ 129,90

Carbon Rear Hugger



Carbon Swingarm Cover



Carbon Engine Spoiler

Carbon Front Mudguard

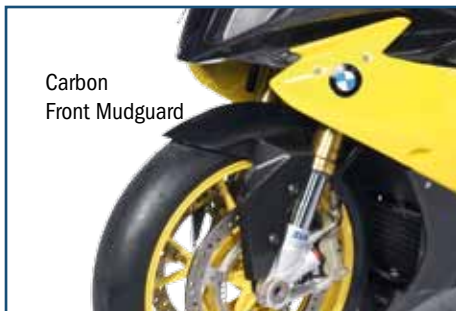

Carbon Upper Tankcover

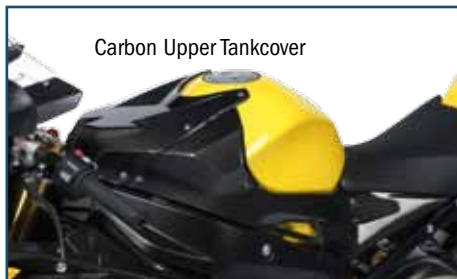

Carbon Tank Side Panels



Carbon Numberplate Holder



Carbon Alternator Cover



Carbon Clutch Cover

Carbon Seat Unit Racing



Carbon Front Fairing

Carbon Fibre Fairings for S1000RR

The S1000RR is the first correct Superbike from the house BMW motorcycle.

We have for the S1000RR articles specially made for the race track (without ABE)

and articles with street homologation (with ABE).

The Items are made of high quality carbon fibre and covered with UV resistant clear lacquer.

You can find more Carbon Fibre Fairings online: www.mhornig.com

ArtNo.	Description	Price
KHO.017.S100S.K	Rear Hugger without ABS - Street	€ 249,90
KHO.032.S100S.K	Rear Hugger with ABS - Street	€ 249,90
KHO.068.S1RAB.K	Rear Hugger without ABS - Race Track	€ 199,90
KHO.078.S1RAB.K	Rear Hugger with ABS - Race Track	€ 199,90
SCA.022.S100S.K	Swingarm Cover left and right - Street	€ 199,90
SCA.073.S1RAB.K	Swingarm Cover left and right - Race Track	€ 179,90
VEU.012.S10SR.K	Bellypan right side - Street	€ 329,90
VEU.013.S10SL.K	Bellypan left side - Street	€ 329,90
VEU.060.S1RST.K	Bellypan right side - Race Track	€ 269,90
VEU.061.S1RST.K	Bellypan left side - Race Track	€ 269,90
KVO.016.S100S.K	Front fender - Street	€ 229,90
KVO.067.S1RAB.K	Front fender - Race Track	€ 169,90
TAO.018.S100S.K	Upper Tankcover - Street	€ 159,90
TAO.069.S1RAB.K	Upper Tankcover - Race Track	€ 129,90
SDR.019.S100S.K	Tank Side Panel right - Street	€ 229,90
SDL.020.S100S.K	Tank Side Panel left - Street	€ 229,90
SDR.070.S1RAB.K	Tank Side Panel right - Race Track	€ 179,90
SDL.071.S1RAB.K	Tank Side Panel left - Race Track	€ 179,90
NHO.024.S100S.K	Numberplate Holder	€ 199,90
LMD.029.S100S.K	Alternator Cover - Street	€ 159,90
LMD.075.S1RAR.K	Alternator Cover - Race Track	€ 129,90
KDA.031.S100S.K	Clutch Cover - Street	€ 139,90
KDA.077.S1RAR.K	Clutch Cover - Race Track	€ 109,90
SIO.062.S1RAB.K	Seat Unit Racing	€ 399,90
VEO.001.S100S.K	Front Fairing - Street	€ 449,90
VEO.054.S1RST.K	Front Fairing - Race Track	€ 349,90



Öhlins Steering Damper Kit

The Öhlins Steering Damper has a piston that is fixed on the shaft and pushes the fluid through a separate parallel passage in the cylinder. The adjustment knob has up to 18 different positions and counts in number of clicks from maximum hard to maximum soft position.

Unit: kit. Mounting position: original

ArtNo.	Description	Price
OHSD 033	Öhlins Steering Damper Kit	€ 365,00



Öhlins Cartridge Kit

Features:

- * Price does not include springs
- * Rebound, compression, and spring pre-load adjusters
- * Easy to change settings
- * Wide range of spring rates available
- * Easy installation and service

ArtNo.	Description	Price
OHFGK 212	Öhlins Cartridge Kit 30 mm	€ 1899,00
OH08792-05	Öhlins Springs	€ 99,00



Öhlins Shock absorber

Features:

- T - Twin tube
 - P - Piggy back' reservoir
 - R1 - Adjustable rebound
 - C1 - Adjustable compression
 - L - Adjustable length
 - B - Integrated hydraulic spring preload adjuster
- Position: rear

Our Öhlins suspensions will be specially adjusted for you! Because of this please inform us about your weight with clothes and helmet, the weight of your luggage (perhaps pillion rider), where you ride (street, off-road, race track) and how you ride (sport, touring, and so on) in the „comment“ of your order.

ArtNo.	Description	Price
OHBM 888	Öhlins Shock absorber T36PR1C1LB	€ 1395,00

Öhlins Front fork

Features:

- * Design based on the well known Superbike fork
- * 43 mm Tin coated inner steel tubes, that protects the legs from damage and keeps friction ultra low
- * External adjusters for rebound-, compression damping and spring preload
- * Optional spring rates available

ArtNo.	Description	Price
OHFGRT 811	Öhlins Front fork FG43	€ 2.995,00



Remus HyperCone

The brand new REMUS HyperCone with conical silencer body is the clear development of the market-proofed REMUS HexaCone and marks the upper end of the REMUS motorcycle high performance silencers.

The innovative highlights of the REMUS HyperCone are the carbon outlet cap in combination with a titanium or stainless steel sleeve, the hexagonal design of the outlet cap and the conical silencer body, guaranteeing maximum ground clearance whilst cornering.

The REMUS HyperCone is EC approved and offers in addition to the well known sonorous REMUS sound a performance and torque increase and convinces with a weight of just 1,5 kg in the titanium version.

ArtNo.	Description	Price
096602 087009	slip on, Stainless, incl. heat shield	€ 448,00
096802 087009	slip on, Titanium, incl. heat shield	€ 554,00



You need a Tank bag, Tear Seat Bag, Duffel Bag, Inside Bag, Universal Bag or Tool Bag?

You can find it under SOFT BAGS in the catalog and online: www.mhornig.com





ArtNo.	Description	Price
X-Navi	X-Navigator	€ 229,00

X-Navigator

Content:

- * X-Navigator GPS
- * Real3D-Maps
- * GPS fixed bracket with Snap-on bracket
- * GPS Mount for 22mm handle bar
- * X-Navigator power adapter for motorcycle battery
- * USB cable
- * Bluetooth-earphone
- * Earphone recharger
- * User's manual
- * Quick installation
- * 2GB SD Card

You can use for example this program to connect your X-Navigator to your PC: Toolbox

Features:

- * Waterproof (IPX7)
- * Video format: support AVI, MOV
- * Audio format: support MP3, WAV
- * E-book format: support TXT
- * Photo format: support JPG, PNG
- * Support SD/MMC cards up to 8GB

* 22 European countries.



ArtNo.	Description	Price
tomtom-urban	TomTom Urban Rider Pro incl. Cardo BT-Headset	€ 399,00
10001498	TomTom Active Bike Dock (power supply)	€ 64,95



TomTom Urban Rider Pro incl. Cardo BT-Headset

- * Map data from Teleatlas with maps of 45 European countries (map coverage see below)
- * Wireless Bluetooth® headset (CARDO scala rider® solo) for spoken route directions and telephone calls direct to your helmet
- * Advanced Lane Guidance (clearly shows which lane to take at junctions)
- * TomTom IQ Routes Technology - intelligent, individual routing
- * improved and simplified user interface
- * up to 8 hours battery life
- * Supplied with a mount for fitting to motorcycles, scooters, bicycles etc.
- * tough and weatherproof body housing (IPX7)
- * Glove-friendly touchscreen
- * 3D street view on the screen
- * Map and arrow navigation, fast recalculation if you deviate from the planned route
- * Bluetooth® interface - for sending navigation instructions to a Bluetooth®-enabled headset (Bluetooth®-headset included)
- * Clear, precise, step-by-step spoken instructions in the following languages (via Bluetooth®-Headset or optional car mount): Bulgarian, Danish, German, English (Australia), English (GB), English (USA), Estonian, Finnish, Flemish, French, Greek, Italian, Japanese, Cantonese, Latvian, Lithuanian, Malay, Mandarin, Dutch, Norwegian, Polish, Portuguese, Romanian, Russian, Swedish, Serbian, Slovenian, Spanish, Spanish (Latin America), Thai, Czech, Turkish, Hungarian
- * Hands-free calling: the TomTom® Urban RIDER transfers calls from your Bluetooth®-enabled mobile phone via a Bluetooth® connection to the Bluetooth® headset so that you can telephone safely without having to take off your gloves or helmet (Bluetooth®-headset included)
- * Correction of your own map, and incorporation of corrections from other TomTom® users through Map ShareTM
- * 30-day latest map guarantee (information at <http://www.tomtom.com/latestmap/>)
- * winding roads - planning a route that avoids unnecessary motorways and includes winding roads (Firmware Update maybe necessary)
- * route recording and sharing with other TomTom Rider users (Firmware Update maybe necessary)

map coverage:

Andorra, Austria, Belgium, Denmark, Spain, Finland, France, Germany, Gibraltar, Greece, Republic of Ireland, Italy, Liechtenstein, Luxembourg, Malta, Monaco, Netherlands, Norway, Portugal, San Marino, Sweden, Switzerland, Turkey, United Kingdom, Vatican City, Bulgaria, Estonia, Latvia, Lithuania, Poland, Czech Republic, Slovenia, Slovakia, Hungary, Croatia, Russian Federation and connector roads of Albania, Bosnia-Herzegovina, Macedonia, Moldova, Montenegro, Rumania, Serbia, Ukraine and Belarus

Components included:

TomTom® Urban RIDER GPS sat nav, map data of 45 European countries, Cardo scala rider® solo Bluetooth® headset, Secure RAM® universal device mount and passive bike dock, 220 V mini usb charger and usb cable

IMPORTANT: The included motorcycle mount is intended for tubular handlebars and without integrated electrical power supply.



ArtNo.	Description	Price
zumo660	Zumo 660	€ 599,00

Nav Garmin Zumo 660

Product Description: 4.3-Inch glove friendly zumo 660 features lane assist, 3D buildings, and lane junction view.

The zumo 660 comes preloaded with European mapping and our special are 794 motorcycle tours within 20 European countries. It comes equipped with stereo bluetooth hands free technology for pairing a phone and headset or helmet.

The zumo 660 has a advanced trip log which features the ability to save multiple trip logs and comes with a rugged mount with wire harness for integration into the motorcycle power and audio system.

Product Features:

- * 4.3-inch, sunlight-readable, glove-friendly touchscreen display; motorcycle and automotive mount both included
 - * Motorcycle console for trip information, including fuel gauge to warn you when it's time to fill up; rugged, waterproof design (IPX7) is resistant to fuel spills and UV rays
 - * Mapping for 40 countries of Europe; preloaded map data features nearly 1.5 million points of interest, including hotels, restaurants, gas stations, ATMs and attractions
 - * Lane assist with junction view directs you to the preferred lane while driving, provides realistic images of upcoming junctions
 - * Built-in travel kit includes features such as picture viewer, world clock, currency and measurement converters and calculator
- and much more

Extra GPS Mount

You can place your GPS in exact the position you want it to be with these Extra GPS Mounts.

The RAM-Ball Plate can be screwed to the X-Navi, Zumo 550, Zumo 660 or TomTom 1 and 2. Then you connect the RAM-Ball Plate with one of the Clamps (60 or 90 mm length).

When you want to mount the X-Navi in combination with one of the following GPS Mounts for the handle bar article no.: NH 1/5; NH 1/3 sw 22; NH 2/1 sw 22; NH 3/1; NH 1/3 c 24; NH 1/3 c 28; NH 3/2; NH 1/6; NH 3/1 15mm you need the RAM-Ball Plate and one of the Clamps.



ArtNo.	Description	Price
NHZ1	RAM-Ball Plate	€ 19,95
NHZ4-60	Clamp 60mm	€ 25,95
NHZ4-90	Clamp 90mm	€ 24,95
NHZS	Lock for Clamp	€ 34,95



GPS or Cam Mounting

Ram-Ball and mounting are CNC machined for TomTom Rider 2 and Garmin Zumo.

You can mount all Ram-Mounts on the Ram-Ball. If you want to install our GPS and Cam Mounting like you can see it on the other pictures you need just a longer screw. The hole in our mounting is 10,5mm large.



ArtNo.	Description	Price
NH 1/8	GPS or Cam Mounting	€ 19,95



GoPro HD Motorsports Hero Camera

GoPro's HD Motorsports HERO is the world's highest performance 1080p HD on-board video and still photo camera. Professional quality 1080p, 960p, and 720p HD resolutions record at 30 frames per second (60 fps in 720p). The HD Motorsports HERO easily mounts to any helmet, motorcycle, ATV, car, plane, jet ski, boat, snowmobile or other vehicle. The camera's quick-release mounting design makes it easy to re-position the camera around your vehicle for professional quality HD video from several angles.

Record up to 2.5 hours on a single charge and up to 9 hours total on a 32GB SD card (not included).

Included are mounts for two helmets and three vehicles, as well as a suction cup for maximum versatility and convenience. The housing is waterproof to 180' / 60m.

GoPro's obsession with sound has conquered the wind. At 85 mph on a motorcycle, you'll enjoy the throaty sound of your motor, not the wind. Inside even the quietest street cars, hear the pull of your motor...not the drone of the wind and road. Included is a 1100mAh rechargeable lithium-ion battery that lasts for up to 2.5 hours of constant recording. With optional accessories, you can also plug the camera into a wall outlet, cigarette lighter, or with any USB-compatible power adapter, wire it directly to your vehicle's electrical system. The battery will charge while you record.

The camera can also shoot automatic 5MP photos at 2/5/10/30 and 60 second intervals during your drive or ride, hands free. Press the shutter button once and record up to 2.5 hours of poster-print quality photos.

Waterproof to 180' / 60m and protected from rocks and other hazards thanks to its removable polycarbonate housing. Replacement housings and lens kits are available, making repairs or refurbishing your HD HERO camera affordable and convenient. It's a GoPro...go for it.™

What's Included:

- 1 HD HERO Camera (5 megapixel)
 - 1 Rechargeable 1100 mAh Lithium-Ion Battery
 - 1 Waterproof Quick-Release Housing (180' / 60 m)
 - 3 Flat, 3M™ Adhesive Mounts
 - 2 Curved, 3M™ Adhesive Mounts
 - 2 Quick-Release Buckles
 - 1 Vertical Surface "J-Hook" Buckle
 - 1 Suction Cup Mount
 - 1 Three-Way Pivoting Side Arm Assembly
 - 1 USB Cable
 - 1 Component Video (HDTV) Cable
 - 1 Composite Video + Audio Out Cable
- Warranty: One Year

ArtNo.	Description	Price
GoPro	GoPro HD Motorsports Hero	€ 349,00

BikeCam 2

BikeCam2 is a high quality easy to use motorcycle video system. Helmet or Bike mounted bullet camera recording systems for bikes, record with sound commentary via your StarCom1, great quality suitable for professional applications including training, racing, track days etc or just great fun for videoing your favourite rides.

The system includes a bullet camera with 3 types of mounting systems including a suction helmet mount. A mini DVR digital video recorder. 2x 1400mAh batteries and a 4GB SD memory card. The max. resolution of the camera is 720 x 576 pixel. This combination 4 GB SD card plus max. resolution lasts for 2 hours video.

Kits include:

- 1 x Bullet camera – Sony HAD CCD helmet/bike camera
- 1 x Camera suction mount kit
- 1 x Camera bar mount kit
- 1 x Camera stick mount kit
- 1 x DVR video recorder
- 1 x 4Gb SD memory card
- 1 x Recorder carry case and strap and belt clip
- 1 x StarCom1 interface cable - allows audio to be recorded, commentary etc..
- 2 x 1400mah batteries
- 1 x universal mains Battery charger + Plug
- 1 x USB cable
- 1 x AV out cable
- 1 x Instruction manual



Cam Holder



Clamps



Lock for Clamp

ArtNo.	Description	Price
BikeCAM2	BikeCam2	€ 349,00
CAM2Halter	Cam Holder	€ 19,95
NHZ4-60	Clamp 60mm	€ 25,95
NHZ4-90	Clamp 90mm	€ 24,95
NHZZ	Lock for Clamp	€ 34,95



Mounting option
(Example R1200GS)



ArtNo.	Description	Price
interphone-f4	One Interphone System F4 stereo	€ 195,00
Twinpack-F4	Two Interphone Systems F4 stereo	€ 349,00

Interphone System F4

Characteristics:

- * Bluetooth v.2.1 EDR wireless technology
- * Windscreen and noise cancelling microphone
- * Full-duplex communication with DSP filter (digital cancellation of wind and background noise)
- * Unique piece made of microphone and headsets to guarantee the best resistance and stability
- * Dual stereo headset for high quality audio (the second headset is removable)
- * Excellent performance up to 180 Km/h
- * Fully waterproof
- * Automatic volume adjustment (adjusts automatically to suit speed and environmental noise)
- * Double fastening system: removable sliding clamp clip and adhesive slide support
- * The control unit can be easily removed
- * Lithium battery
- * Dimensions: 90x46x20 (mm)
- * Weight: 83g including ear phones and microphone

Capacity: * Communication up to 500 m

Performance: * Active use autonomy: up to 10 hours (indicative time of use alternating the various functions)

* Stand-by time: up to 700 hours * Recharge time: 3 hours

You need two pieces for driver & pillion rider or driver & driver.

Battery Exchange Service

Battery exchange service for the Interphone head sets (see pictures). Battery exchange service means that we replace your battery with a new one. That means you have to send us your Interphone!

ArtNo.	Description	Price
65041	Battery Exchange Service	€ 20,00







Bavaria Outdoor Cover

Effective and inexpensive. Light motorcycle cover made of special coated foil. Frost resistant to -30 degrees, UV-stabilized, water resistant and with grommets to fasten the cover.

Size: Length=2,30m, Height front=1,50m, Height rear=0,85m, Width=0,60m

ArtNo.	Description	Price
100 40 303	Outdoor Cover	€ 49,90



Indoor Cover

The outer material has a silky quality and the inside is very soft and easy on the paint. Keep your motorcycle looking showroom new.

This cover is made of the best quality cloth to ensure your bike stays clean and dry inside your garage.

„Breathing“ membrane material, moisture is „transported“ to outside, Tightening band, Length=2,30m, Height front=1,50m, Height rear=0,85m, width=0,60m

ArtNo.	Description	Price
100 40 322	Indoor Cover	€ 99,90



Supercover Outdoor Cover

100% waterproof yet breathable and designed to fold nicely. Intended for motorcycles left outside overnight or for extended periods of time. Protect your investment from the elements.

Heat and cold resistant Strong but soft coated material. Prevents damage to paint on inner side. UV stable, Tightening band, Additional plastic loops

Size: Length=2,30m, Height front=1,50m, Height rear=0,85m, Width=0,60m

ArtNo.	Description	Price
100 40 312	Supercover	€ 89,90



Autosol Bluing Remover

Removes blue and brown staining from stainless steel exhaust systems. Your exhaust will look brilliant again after you used it. Contents: 125 ml, Packaging: bottle

Ingredients: AQUA, ALUMINA, HYDROCHLORIC ACID, Fatty alcohol ethoxylates, OLEIC ACID, Ethinylcarbinolalkoxylate, XANTHAN GUM, COCAMIDOPROPYL BETAINE

ArtNo.	Description	Price
D01290	Autosol Bluing Remover	€ 12,50

Garage trolley

Garage trolley basic -carrier for bikes with centre stand up to 45 cm width. Surface 23x48cm
Suitable for BMWs (old and new) carries up to 320 kg or 400 kg. Brakes on all four wheels!
Anti-slip rubber pad; Bargain!

ArtNo.	Description	Price
skater 320	320 kg	€ 99,00
skater-heavy	400 kg; 75mm high	€ 124,90

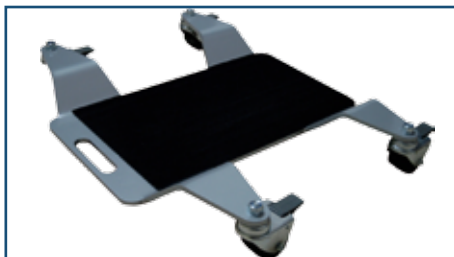

Side stand foot enlargement

Feel safer parking your bike on dirt or asphalt with a side stand enlargement! made of: aluminium
size: 12cm x 12cm

ArtNo.	Description	Price
0050	Side stand foot enlargement	€ 4,50



Throttle Rocker

Throttle Rocker is a device that easily wraps around the throttle grip of any motorcycle. It protrudes away from the grip so that the contoured portion fits comfortably against the heel and palm of the hand. Using the heel of your hand, the rider applies minimal downward pressure on the Throttle Rocker making the throttle rotate. Additionally, Throttle Rocker works as a resting place for the hand, reducing fatigue on long trips.

ArtNo.	Description	Price
80055	Throttle Rocker	€ 10,40



Loctite

Thread locking compounds are used throughout industry, especially in automotive applications, to provide an inexpensive and reliable way of ensuring that fasteners do not come loose. They are highly specialised liquid compounds that cure quickly to form a bond between the surfaces they join.

ArtNo.	Description	Price
L.10004020	5ml Loctite	€ 7,95



Battery Pole Fat

For battery-poles and electrical contacts, protects against corrosion. Volume: 50g.

ArtNo.	Description	Price
10004881	50g Battery Pole Fat	€ 3,95





Copper paste

High performance Copper Paste 100g. Resistant -30C to +1300C. Cold, hot and sea water resistant. An absolute must when you install new brake pads.

ArtNo.	Description	Price
L.10004267	100g Copper paste	€ 5,95

Anti Squeak Paste

The Anti Squeal Paste can be used for the whole brake system (bolts, pins, ...). It will avoid squeaking and contains no copper so it can also be used safely with ABS brake systems.

ArtNo.	Description	Price
L.10004882	35g Anti Squeak Paste	€ 3,99

Metal Polish

Aluminium, Stainless steel and chrome polish.

ArtNo.	Description	Price
L.10004015	100g Metal Polish	€ 5,25

Xerapol

Plastic polish 50g.

ArtNo.	Description	Price
L.10004318	50g Xerapol	€ 12,50

Brake fluid

High performance brake fluid for street and off-road DOT 5.1 made by Lucas.

ArtNo.	Description	Price
S.PFB 550	0,5 litre Brake fluid	€ 7,95



Gel-Special-Cleaner

Procycle Gel-Special-Cleaner for motorcycles.

ArtNo.	Description	Price
L.10004909	1litre Gel-Cleaner	€ 10,45
L.10004947	5litre Gel-Cleaner	€ 24,90



Foam Cleaner

Bike Clean foam cleaner. For the fast laundry occasionally, without water, simply up-spray and wipe off, seals the lacquer, also for helmets and view carbon parts suitably.

ArtNo.	Description	Price
903-004	1 Can Foam Cleaner	€ 9,95



Insect Remover

An improved active formulation easily removes dead insects. Spray the affected surfaces and allow to take effect for several minutes. Then using a sponge and plenty of water rinse off dissolved insects and dirt. Silicone free and AOX-free.

ArtNo.	Description	Price
0893470	500ml Insect Remover	€ 9,90



Tyre fix

No need to change the tyre after you have holed it. Useable for all tyre types. Allows you to ride to the next petrol station or repair shop.

ArtNo.	Description	Price
L.10004304	400ml Tyre fix	€ 7,95



Chain Clean / Chain Spray

Chain Cleaner 500ml. Is ideal for cleaning all types of drive chains from motorcycles, karts, bicycles to industrial chains. The chain is thoroughly cleaned and dries quickly to leave the chain ready for lube.

Chain spray 400ml. Cleans all types of motorcycle chains (road and offroad) and those of other vehicles (bicycle, moped, go kart, ATV). Removes all encrusted deposits : dust, sand, soil, oil. Its chlorine-free extreme grease removal formula is perfectly suited to O-ring, X-ring, Z-ring chains.

ArtNo.	Description	Price
38904	500ml Chain Clean	€ 9,40
38804	400ml Chain Spray	€ 9,90





The mineral or synthetic AGIP engine oil of the latest generation meets the requirements of BMW's specifications or classifications and because of this they fit perfect to the superior BMW riders.

SAE 15W-50 is standard for:

BMW R1200GS
BMW R1200R
BMW R1200RT
BMW R1200S
BMW R1200ST

SAE 10W-40 is standard for

BMW G650X *
BMW F650* BMW F800*
BMW R1100* BMW R1150*
BMW R1200C BMW R1200CL
BMW K1200* BMW K1300*

ArtNo.	Description	Price
21611	TEC 4T engine oil SAE 15W-50 1 Litre	€ 14,95
27112	City TEC 4T engine oil SAE 10W-40 1 Litre	€ 9,95
28912	CITY HI TEC 4T engine oil SAE 5W-40 1 Litre	€ 14,95
29411	Racing 4T engine oil SAE 20W-50 1 Litre	€ 17,95



Transmission oil

The AGIP transmission oils are extreme pressure gear oils recommended for hypoid gears operating under severe conditions and for very highly loaded gears in general, especially those subject to dynamic loads. These AGIP transmission oils meet the requirements of BMW's specifications.

We recommend: SAE 85W-140

ArtNo.	Description	Price
31312	SAE 85W-140 1 Litre	€ 12,55
31012	SAE 85W-90 GL5 1 Litre	€ 11,95
30611	Synthetic SAE 75W-90 1 Litre	€ 13,95

Chain Oiler

Just pull the button (Image 2) every 300 - 400 km and your chain will be oiled for 5-8 seconds. For example pull the button after a tank stop and ride the first 5-8 seconds a little bit slower. You can also oil your chain with your bike on the main stand.

- * Wheel and Tyres will stay clean
- * Oil as often as you need
- * Pull the button every 350km
- * easy to install and to use
- * no connection to the carburettor
- * no electronic system
- * cheap refilling
- * longer life of the chain and sprockets

Fits for BMW models

F650, F800GS, F800R and G650



ArtNo.	Description	Price
BK OSCO 001	Chain Oiler	€ 129,90
BK OSCO 002	Refill Oil (180 ml)	€ 5,90

Chain Kits

About the power of the machine really get on the road is the chain kit from Regina, the best choice.

The chain and sprockets kit for your BMW F650, ST MY 93-00 consists of an open chain with 110 chain links and a transmission of 16/47.

The chain and sprockets kit for your BMW F650GS, Dakar MY 99-07 consists of an open chain with 112 chain links and a transmission of 16/47.

The chain and sprockets kit for your BMW F800GS consists of an open chain with 116 chain links and a transmission of 16/42.

The chain and sprockets kit for your BMW F650GS 08-* consists of an open chain with 116 chain links and a transmission of 17/41.

The chain and sprockets kit for your BMW F800R consists of an open chain with 116 chain links and a transmission of 20/47.

The chain and sprockets kit for your BMW G650X Country MY 07-* consists of an open chain with 112 chain links and a transmission of 16/47. This bevel is made of aluminium for a better weight!

The chain and sprockets kit for your BMW G650X Challenge MY 07-* consists of an open chain with 112 chain links and a transmission of 15/47. This bevel is made of aluminium for a better weight!

The chain and sprockets kit for your BMW G650X Moto MY 07-* consists of an open chain with 112 chain links and a transmission of 16/47.



ArtNo.	Description	Price
410 K	F650, GS, ST MY 93-00	€ 114,95
416 K	F650GS, Dakar MY 99-07	€ 119,90
301 K	F650GS 2008-*	€ 174,95
302 K	F800GS	€ 174,95
219 K	F800R	€ 189,95
333 K	G650X Country MY 07-*	€ 139,95
334 K	G650X Challenge MY 07-*	€ 139,95
335 K	G650X Moto MY 07-*	€ 129,90
4991	Tool for closing a chain	€ 49,95
691 A	Tool for opening a chain	€ 31,95

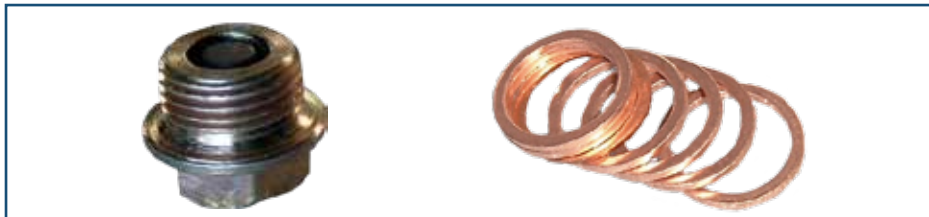

Magnetic sump plug / Copper washer

Finest metallic abrasion is safely retained and thus removed from the oil circuit.

Order Copper washer the same time.

ArtNo.	Description	Price
1854012	magnetic screw plug all R 850/1100/1150/1200	€ 5,95
1854013	Copper washer for magnetic sump plug for BMW R bikes (for M16)	€ 0,50
1854010	Magnetic screw plug K 1100/1200 RS/GT & LT	€ 5,90
1854011	Copper washer for magnetic screw plug for BMW K bikes (for M18)	€ 0,50
1854014	Copper washer for rear drive screw plug (for M14)	€ 0,50



Blind Angle Mirror

A little piece but much more security. The blind angle mirror allows you to see into the blind angel.

32mm diameter, can be glued on every mirror.

Price per item.

ArtNo.	Description	Price
28060	Blind Angle Mirror	€ 3,95



Quick Connect

For the fuel pipe, each part of the Quick Connector seals individually and avoids leaking petrol. Fits all fuel pipes and 8mm tubes. Resistant to acid, oil and petrol with 2 hose clip (see picture).

You need e.g. for a R1100S and R1100R 2 pieces.

Not for R1150GS Adventure.

Price for one Quick Connector.

ArtNo.	Description	Price
13-31119	Quick Connect	€ 19,95



Tyre Pressure Control

The Check pressure at-a-glance for tyres 1,3-3,0 bar

Put in the correct pressure. Screw on and leave. When

pressure reduces - central red indicator will looking above the green indicator portion. Caps are replaceable.

No substitute for regular pressure check.

ArtNo.	Description	Price
208-164	1 Set Tyre Pressure Control	€ 8,99



Round head screws

Round head screws with hexagon socket.

ArtNo.	Description	Price
60010	S/S M6 x 12	€ 0,40
60050	S/S M5 x 10	€ 0,37
60055	S/S M5 x 12	€ 0,39
60060	S/S M5 x 16	€ 0,49
60065	S/S M5 x 20	€ 0,50
60067	S/S M5 x 30	€ 0,58
60070	S/S M5 x 50	€ 0,69
0421005	transp.Shim Ø 5,3mm	€ 0,14
0421006	transp.Shim Ø 6,4mm	€ 0,14

Screw & captive washer

Rust-resistant screws.

ArtNo.	Description	Price
60075	M6 x 12	€ 0,49
60077	M6 x 25	€ 0,60
60080	M5 x 12	€ 0,40
60082	M5 x 16	€ 0,52
60084	M5 x 20	€ 0,53
0421005	transp.Shim Ø 5,3mm	€ 0,14
0421006	transp.Shim Ø 6,4mm	€ 0,14

Key fob

Piston made of aluminium, gold anodized, diameter 15mm, a unique key fob especially for you!

ArtNo.	Description	Price
S.415-711	Key fob	€ 4,75

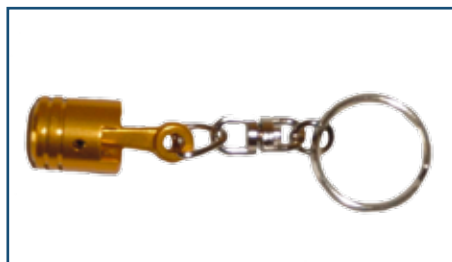

90 degree Valve Stem Adapter

This is the solution to getting at those hard to reach valve stems. Just screw it onto the valve stem and any air hose will fit easily. Note: This piece is designed for convenience use only. It will simplify checking and changing the tire air pressure.

NOTE: *Do not operate your vehicle with this piece installed as doing so may cause valve stem failure. This failure may cause loss of control of the vehicle.

ArtNo.	Description	Price
95-36292	90 degree Valve Stem Adapter	€ 7,95





Loop Antenna

The loop antenna of the electronic immobilizer may fail. As a result, the motor does not get the necessary signal to trigger a start operation. The loop antenna should be included in the baggage of every BMW driver. Very easy to assemble:

1. Deduct the cable plug from the old antenna.
2. Connecting new antenna.
3. Holding spare key to the ring antenna.
4. Start with original key.

Fit for all models with CAN-bus.

ArtNo.	Description	Price
7705247	Loop Antenna	€ 39,90



Signal vest

EN 471 size: universal.

colour: bright yellow.

Material: 100% polyester

ArtNo.	Description	Price
L.10001035	Signal vest	€ 3,45



First aid kit

First aid kit (only 15x12x4cm) especially made for motorcycles. Highly visible red bag with three sided zip. The contents are packaged waterproof!

ArtNo.	Description	Price
L.10002120	First aid kit	€ 9,95



Bulb box

1 headlight bulb H 4/12 V, 1 Lamp for number plate bulb 5 Watt, 1 turn signal bulb 21 Watt, 1 brake light bulb 21/5 Watt, 1 Capless for number plate light, 1 parking light bulb 4 Watt, 1 warning light and instrument bulb 5 Watt!

ArtNo.	Description	Price
L.10031110	Bulb box	€ 10,95

LED Pocket Lamp

The perfect Pocket Lamp for adventures: 35g light, can be charged with the cigarette lighter, very long power-on time, flashing light 75hrs., continuous light about 4hrs., with a magnet in the shaft. Simple to mount the pocket lamp on the tank of your bike when you want to warn of danger. With 7 LEDs.

You can use our Adapter cable Adapter cable (part nr. 10003690) as a cigarette lighter adapter.

ArtNo.	Description	Price
MT7LC	LED Pocket Lamp	€ 29,90



Heated Grips

Heated grip rubbers. Easy to assemble. Suitable for all bikes. Anti-slip rubber coating. Only 1,5A current.

ArtNo.	Description	Price
MHG	1 Set Heated Grips (for left & right)	€ 69,90



Antifog

Clear Antifog foil. Doesn't fit the Evo 5 helmet.

ArtNo.	Description	Price
S.20012009	Antifog	€ 13,75



Disc Lock

Added security for your motorcycle. Drop Forged Steel with a 10mm angled pin. Quickly and easily attaches to the brake disc. Storage pouch included.

ArtNo.	Description	Price
10001871	Disc Lock	€ 23,90





Art. 90026



Art. 10003690



Art. 90025



Art. 61-44200



Art. 61-44201

Plug, Power socket, Adapter cable

Art. 90026 Plug

Fits into original BMW socket or iso-Plugbox as we Nr. 90025. Perfect to connect extra items like Navigation. Plug without cable. (+ Pin middle)

Art. 10003690 Adapter cable

Fits our 12v socket (ArtNr 90025).

Gives a connection between the socket and products with cigarette lighter plug.

For all 12 volt items with cigarette lighter plugs, like hand lamps, mobile-phone battery charger, GPS-system etc. Total length ca. 20cm.

Art. 90025 Extra power socket

Power socket with cover and mounting bracket, 120 cm line and fuse. This accessory plug kit allows you to plug in any BMW accessory. This is the DIN. or BMW standard plug. It is smaller than the SAE or cigarette light style plugs. It is also standard on Volkswagen Buses and Vanagons up to 1984.

This plug is made for it Plug (Art-Nr.: 90026)

Adapter cable for cigarette lighter plug (Nr.: 10003690)

Art. 61-44200 Cigarette Lighter Socket Kit

This kit features a standard 12 volt socket and allows you to plug in the standard (cigarette lighter style) devices that you may use in your motorcycle. The length of the wire is 80cm.

Art. 61-44201 Mounting for 22mm handlebar

ArtNo.	Description	Price
90026	Plug	€ 4,50
10003690	Adapter cable	€ 15,45
90025	Power socket	€ 14,90
61-44200	Cigarette Lighter Socket Kit	€ 14,95
61-44201	Mounting for 2mm handlebar	€ 4,90

Attention!! You can find more Accessories under
www.mhornig.com

Battery Charger Optimate 4

Without plug but with a cable and clips which you can connect direct to your battery in order to charge it without disconnecting.

Especially for bikes (08 - *) (Article 208-037)

Note: All new bikes with Can-Bus like K1200S, R & GT, R1200GS, RT, ST, S & R, F800S & ST and many more. Turn the ignition on. That will enable the Can-Bus system to initialise charging.



Battery Charger Optimate 4 Dual for CanBus

the ultimate all-in-one tool for 12V battery care at home, now with DUAL PROGRAM that diagnoses, recovers, charges, tests and optimally maintains, automatically. Charge the battery direct or select the program to charge via the 12V port on your CAN-bus equipped bike. Our article number 90012 is already equipped with a plug for your BMW plug box!



Art. 208-031-03

ArtNo.	Description	Price
208-037	Battery Charger Optimate 4 without plug You can go directly to the battery. The connector for the charger under the seat and place convenient because then the charger.	€ 69,90
90012	Battery Charger Optimate 4 Dual for CanBus with plug for BMW plug box	€ 72,90
208-031/04	Extra cable for motorcycle plug box (spare part)	€ 14,50
208-031-03	Eye cable (spare part)	€ 9,65

Grip Puppies

These Grip Puppies will give more comfort to your ride and less vibrations. They simply slips over your standard rubber grip (no need to remove standard grip).

Grip Puppies will fit all standard grip sizes.

The standard Grip Puppy will fit standard bars sizes and grips. They are 5" (12.7cm) long and will fit grips that are 1.25 (3.17cm) to 1.45 (3.68cm) inches in diameter. Grip

Puppies can be trimmed to length with a craft knife or similar if needed (using appropriate care!)

These are great for adding a little extra thickness and comfort to your grips.

Will also work with heated grips.

INSTALLATION INSTRUCTIONS: You do not need an air compressor. Just apply a little soapy water to the inside of the Grip Puppies and slide them over your existing grips.

Allow to dry then enjoy the ride! In the video above we show how you can use an air compressor.



ArtNo.	Description	Price
gripp-puppies	Grip Puppies	€ 19,95



Twinmax synchroniser machine

A correct and proper synchronisation of the carburettor or the fuel-injection system is very important for perfect engine running: smooth engine running, excellent response, no vibrations, optimal mileage and less wear.

Compared to other synchronic machines the TWINMAX compares the vacuum on both sides with the help of a single pressure sensor (differential pressure gage) and shows the difference on the indicator.

Synchronizing with TWINMAX is easy and quick. The result is professional precision.

The TWINMAX is

- * usable on almost every engine
- * suitable for fuel injection
- * applicable for any number of cylinders
- * tune with the highest precision
- * electronic, there are no moving parts
- * free of Mercury, springs or weights
- * its works regardless of the atmospherics
- * very compact (11 x 8 x 4 cm).

The set contains:

- * 1x TWINMAX MKIII, short operating instruction in English on the instrument,
- * 2x petrol strong elastic hoses, each one is 70 cm,
- * 2x connecting nipples, 5 mm for Japanese bikes
- * 2x connecting nipples, 6 mm for Japanese bikes
- * 2x connecting tubes for BMW
- * 1x 9volt brand block battery

ArtNo.	Description	Price
Twin-MKIII	Twinmax synchroniser machine	€ 87,95

Diagnostic Equipment

A small and handy tool.

This item shows you any error in the error memory, gives you more information about it, helps you to solve that problem and you can remove the error from the error memory.

With many extras like engine temperature, engine speed, lambda, injection time and many more.

Fits for the BMW models:

F650, F800, G650, K1200, R1100, R1150, R1200



ArtNo.	Description	Price
345061	for BMWs with 10 pol. diagnostic plug	€ 599,00
342510	Adapter for 3 pol. diagnostic plug	€ 29,95

Hydraulic lifting platform

-Protected from overload -Easy lifting and lowering with pedal -The platform is easy to move because of its 4 rollers

up to 360kg:
 -Weight ca. 100kg
 -Size(LxWxH): 2200x685x250 mm
 -Useable length 1400mm

up to 450kg:
 -Weight ca. 130kg
 -Max. height 700-750 mm
 -Size(LxWxH): 2200x670x250 mm
 -Useable length 1820mm



ArtNo.	Description	Price
91391524362	up to 360 kg	€ 469,00
910770-24357	up to 450 kg	€ 529,00

Shipping within Germany for free!
 Shipping within the EU between 70,- and 150,- Euro!
 Please inquire.



Oil filter

(for other motorcycles please ask)

Only the correct Oil filter ensures that your oil is free of particles for the long life of your engine and perfect smooth running.

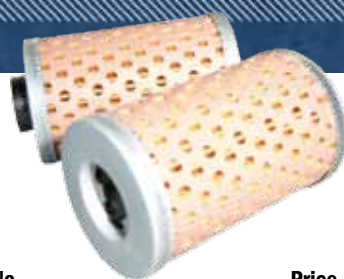

Models	ArtNo.	Price
R80/R100 without Oil cooler all models, one piece	30010	€ 8,95
R80/R100 without Oil cooler all models, two pieces	30009	€ 11,90
R100 with Oil cooler all models	30013	€ 9,90
F650	30011	€ 5,40
F650GS MY 08-* / F800GS MY 08-* / F800S & ST / F800R	30014	€ 11,90
G650X - models	30011	€ 5,40
K100RS & LT / K1200LT / K1200RS & GT	30012	€ 11,40
K1200S, R, GT	30014	€ 11,90
K1300S, R, GT	7721779	€ 13,40
R850/1100/1150 GS / R850/1100/1150R	30012	€ 11,40
R1100/1150 RS, RT	30012	€ 11,40
R1100S	30012	€ 11,40
R850/1200C / R1200CL	30012	€ 11,40
R1200RT, ST, S, R	30014	€ 11,90
R1200GS / R1200GS Adv., / HP2	30014	€ 11,90

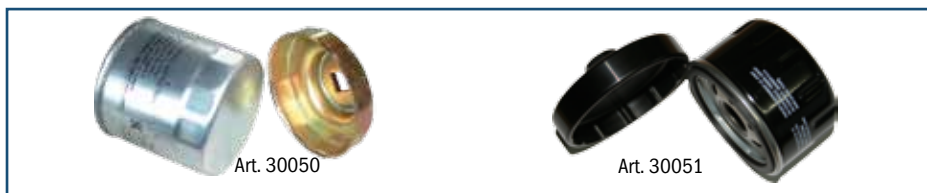

Oil filter spanner

Made of high quality steel to remove the oil filter as fast and easy as the professionals!

Art. 30050: Wrench size 74 mm for square 1/2 inch.

Art. 30051: hexagon for 19 mm spanner size.

Models	ArtNo.	Price
F650GS MY 08-* / F800GS MY 08-* / F800S & ST / F800R	30051	€ 24,95
K100RS & LT / K1200LT / K1200RS & GT	30050	€ 11,90
K1200S, R, GT	30051	€ 24,95
K1300S, R, GT	30050	€ 11,90
R850/1100/1150 GS / R850/1100/1150R	30050	€ 11,90
R1100/1150 RS, RT / R1100S / R850/1200C / R1200CL	30050	€ 11,90
R1200RT, ST, S, R	30051	€ 24,95
R1200GS / R1200GS Adv., / HP2	30051	€ 24,95



Air filter

(for other motorcycles please ask)

Choose the correct Airfilter and give your bike the necessary air to breath. It'll be worth it!

You can choose between a original airfilter or a K&N duration Airfilter for more power.

Models	Description	ArtNo.	Price
F 650 -2000	Air filter	40011	€ 6,25
F650GS / Dakar (01-*)	Air filter	050020	€ 14,95
F650GS MY 01-*	K&N duration Air filter	40022	€ 81,95
F650CS / G650X-models	Air filter	10050116	€ 14,95
F650GS (08-*)/F800S/F800ST/F800R/F800GS	K&N duration Air filter	10050781	€ 51,95
K1100RS>	K&N duration Air filter	40026	€ 85,95
K1200RS/K1200GT MY 01-05/K1200LT	K&N duration Air filter	40027	€ 79,95
K1200RS/K1200GT MY 01-05/K1200LT	Original Air filter	1371916	€ 24,80
K1200S (2x) /K1200R/K1200GT MY 06-*	K&N duration Air filter	10050779	€ 85,95
K1300S,R,GT	K&N duration Air filter	10050779	€ 85,95
K1200S (2x)/K1200R & R-Sport/K1200GT MY 06-*	Air filter	7703583	€ 16,80
R850/1100/1150GS, R / R1100/1150RT, RS	Air filter	40012	€ 15,40
R850/1100/1150GS, R MY 93-*	K&N duration Air filter	40023	€ 59,90
R1100/1150RT MY 94-*/ R1100/1150RS MY 92-*	K&N duration Air filter	40023	€ 59,90
R850/1200C MY 98 -*	K&N duration Air filter	40024	€ 56,95
R1100S MY 99-*	Original Air filter	7650976	€ 16,35
R1100S MY 99-* and Boxer Cup	K&N duration Air filter	40025	€ 60,95
R1200GS & Adv., HP2, R1200RT, ST, S, R	K&N duration Air filter	050157	€ 74,90
R1200GS & Adv., HP2, R1200RT, ST, S, R	Original Air filter	7672552	€ 15,85



Recharger Filter Care Service Kit

A six-step maintenance system designed to clean any K&N Filtercharger® Air Filter.

Restores air flow efficiency so your Filtercharger performs like new!

Includes: 6.5 oz. Spray Oil & 12 oz. Filter Cleaner.

ArtNo.	Description	Price
04249	Recharger Filter Care Service Kit	€ 19,50

Front brake pads

Lucas ABE/TÜV brake pads are characterised by high quality at the best price. All pads are asbestos free and free from heavy metals. Very good shelf life, excellent wet braking behaviour.



Models	ArtNo.	Price	ArtNo.		Price
			Organic Pad	Sintered Pad	
F650* till 93-*	20042	€ 28,80	20043	€ 31,90	
F650GS 2008-*/ F800GS and HP2 models	20042	€ 28,80	20043	€ 31,90	
F800S & ST / F800R / G650Xmoto	MCB 683	€ 25,90	MCB 683SV	€ 29,95	
G650XChallenge / G650XCountry	20042	€ 28,80	20043	€ 31,90	
K1100RS MY 92-96 / K1100LT My 93 - 99	20031	€ 28,70	20033	€ 32,40	
K1200LT MY 97 - 00	20031	€ 28,70	20033	€ 32,40	
K1200LT with Integral ABS MY 11/00 -	20035	€ 27,90	20037	€ 33,90	
K1200GT MY 03-*/ K1200RS MY 01-*	20034	€ 29,40	20036	€ 34,50	
K1200RS 96 - 00	20031	€ 28,70	20033	€ 32,50	
K1200S / K1300S	20034	€ 29,40	20036	€ 34,50	
K1200R / K1300R			20037	€ 33,90	
R850GS 95-02 / R1100GS 93- 99	20031	€ 28,70	20033	€ 32,40	
R1150GS 99-01	20031	€ 28,70	20033	€ 32,40	
R1150GS MY 01 - * / R1150 Adv. MY 01 - *	20034	€ 29,40	20036	€ 34,50	
R850/1100R / R1100RS Bj. 92 - 01	20031	€ 28,70	20033	€ 32,40	
R 1150 GS & Adv. MY 03-05	20035	€ 27,90	20037	€ 33,90	
R1150R MY 01-03 Rockster MY 03-*	20035	€ 27,90	20037	€ 33,90	
R850C, Avantgarde 95-02	20031	€ 28,70	20033	€ 32,40	
R1200C, Avantgarde 97-02	20031	€ 28,70	20033	€ 32,40	
R1200CL, Montauk MY 03-*	20035	€ 27,90	20037	€ 33,90	
R1150RS /R1100S MY 01-*/ with Integral ABS	20035	€ 27,90	20037	€ 33,90	
R1100S 94 - 11/00	20031	€ 28,70	20033	€ 32,40	
R1100S MY 01-*/ without Integral ABS	20034	€ 28,70	20036	€ 34,50	
R1100RT 92 - 01	20031	€ 28,70	20033	€ 32,40	
R1150RT MY 00-*/ with Integral ABS	20034	€ 29,40	20036	€ 34,50	
R1200GS, RT, S, ST	20034	€ 29,40	20036	€ 34,50	
HP2 Sport			MCB 792SV	€ 34,90	
R1200R	20035	€ 27,90	20037	€ 33,90	
S1000RR	MCB 829SV	€ 50,90			
S1000RR Sinter Road Racing brake pads			MCB 829SRQ	€ 58,95	
S1000RR Sinter Carbon Racing brake pads			MCB 829CRQ	€ 72,20	



Rear brake pads

Lucas brake pads

All brake pads are environmentally friendly manufactured without asbestos, cadmium, lead and formaldehyde.

Models	ArtNo.	Price	ArtNo.		Price
			Organic Pad	Sintered Pad	
F650 models till 93-*	20022	€ 27,60	20026		€ 29,95
F650GS 2008-*/ F800GS, S&ST, R	20022	€ 27,60	20026		€ 29,95
G650X models	20022	€ 27,60	20026		€ 29,95
K1100RS 92-96 / K1100LT 89 - 99	20024	€ 26,90			
K1200RS & GT (all models)	20024	€ 26,90			
K1200LT with and without Integral ABS	20023	€ 29,40			
K1200S,R / K1300S,R	20021	€ 28,40	20025		€ 32,60
R850/1100/1150GS, R / R1150RS/RT	20021	€ 28,40	20025		€ 32,60
R1100RT	20021	€ 28,40			
R1200C Montauk MY 93 - *	20021	€ 28,40	20025		€ 32,60
R1200CL	20023	€ 29,40			
R1100S	20021	€ 28,40	20025		€ 32,60
R1200GS, R, RT, S, ST	20021	€ 28,40	20025		€ 32,60
HP2 Sport			20025		€ 32,60
HP2 models	MCB 648	€ 27,90	MCB 648SH		€ 31,90
S1000RR	20022	€ 27,60	20026		€ 29,95



Clutch lining

Clutch linings from Lucas are among the best in the world!

Models	ArtNo.	Price
F 650, ST 94 - 00 & G650GS	H.MCC 604-7	€ 76,90
F 650, ST 94 - 00 & G650GS Set Clutch Springs	MEF 160-6	€ 19,75
R1100R, RT, RS / K1100LT	H.MCC 602	€ 79,50
R1100R, RT, RS / K1100LT	H.MCC 602-S (Sintered)	€ 164,90
K1200RS & GT	H.MCC 607	€ 77,95
R1100S, R1150GS, R, RT, RS	H.MCC 608	€ 79,50
R1200C & CL models	MCC 606	€ 72,90
R1200GS,HP2 / R1200RT, ST, S, R	MCC 609	€ 79,90
R1200GS,HP2 / R1200RT, ST, S, R	MCC 609-S (Sintered)	€ 169,90

Oil Resistant Clutch

Our Oil Resistant Clutch will not slip even when oil is on it, which can happen very easily when the simmering is broken.

This is a huge advantage for globe trotter, touring rider and everybody who rides a lot.

Another advantage is that this clutch can transfer much more torque than usual clutches.

The organic lining provides smooth transmission of power and is also very durable.



Models	ArtNo.	Price
R60-R100 till 1976 - 09/1980	2122332	€ 198,00
R80-R100 till 09/1980	2122512	€ 198,00
K1/ K100RS 4V 89-93, K100/K100LT 83-91, K1100LT/RS	2122795	€ 198,00

Alarm Disc Lock RK15

Quickly and easily attaches to the brake disc. Storage pouch, three keys and two AAA batteries are included.

S.R.A homologated, independent alarm, which can be turned on and off by the rider and intelligent alarm, which needs a minimum vibrations to get activated, works with two AAA batteries, which last very long and you can get them anywhere, waterproof, steel housing.

rka2 can be mounted to your motorcycle, rkrem is the memory cable



ArtNo.	Description	Price
rk15	Disc Lock RK15	€ 119,00
rka2	Motorcycle Mount	€ 35,00
rkrem	Memory Cable	€ 4,50

Disc Lock RK8

Added security for your motorcycle. Drop Forged Steel with a 5,5mm angled pin. Quickly and easily attaches to the brake disc. When somebody tries to steal your motorcycle 110db will hold him off. Storage pouch, three keys, Allen key for changing the batteries and six batteries included.



ArtNo.	Description	Price
rk8	Disc Lock RK8	€ 38,00
rkrem	Memory Cable	€ 4,50

Front Brake Disks

Cool design, the finest high technology, with TÜV, and all for an affordable price. After extensive testing and successful application in motor sport, we're introducing the new Lucas Alien brake disc to the marketplace.

The Lucas Brake Disks are eye-catching at first glance. But behind the elegant design there is really solid performance. The basic material used for the Lucas Brake Disk is a high-strength steel alloy to the standard 35 HRC.

Models	ArtNo.	Price	ArtNo. Alien	Price
F650 94-05 / G650 Xchallenge, Country F800GS	MST 337	€ 153,50	MST 337RAC	€ 169,00
F800S/ST K1200GT 03-* / K1200GT Integral 01-* K1200LT, R, S / K1200RS 01-* R850R 04-* / R1100S 01-04 R1150GS/adv. 03-* / R1150R & Rockster R1150RS / R1150RT Integral 00-* HP2 Megamoto R1200R, S, RT, ST	MST 357 MST 357 FS (floating system)	€ 149,00 € 219,90	MST 357RAC	€ 164,00
K1200RS 97-00 / K1200LT 98-99 R850R 02-03 / R850GS 98-00 / R850C 99-00 R1100S 98-00 / R1100GS R1150GS/Adv. 99-02 / R1200C&CL R1200GS / HP2 Enduro	MST 239 MST 239 FS (floating system)	€ 153,70 € 253,70	MST 239RAC	€ 169,00
R850R 95-01 / K100RS 16V 90-92 / K1 K1100LT, RS R1100R 95-* / R1100RS, RT	MSW 200	€ 199,90		



You can find more Spare and War parts
online: www.mhornig.com

Rear brake disc

Lucas brake discs are made of high quality steel. Special surface avoids vibrations and corrosion. Maximum braking guaranteed! with EU homologation!

Models	ArtNo.	Price	ArtNo. Alien	Price
F650 94-05	MST 330	€ 99,90		
F800S, ST / K1200R, S R1200GS / HP2 Enduro R1200R, S	MST 372	€ 153,40	MST 372RAC	€ 169,00
R850GS 98-00 / R850R 95-01 / R850R 04-* R1100GS 94-99 / R1100R 95-* R1100RT 96-* / R1100S / R1150GS/Adv. R1150R & Rockster / R1150RS, RT	MST 331	€ 134,90	MST 331RAC	€ 136,90

Fuel Filter

An efficient fuel filter is an absolute necessity for advanced injection engines. The filter paper has the perfect pore size in order to assure constant and high quality fuel supply.



ArtNo.	Description	Price
2325859	Fuel Filter	€ 19,95

Spark plugs

(for other motorcycles please ask)

Not only in a race can the right spark at the right moment determine victory or defeat.



Models	ArtNo.	Price
R1100GS, R, RT, RS, R850&1150GS, R850&1150R, R1150RT, RS, R1100S, R850C&R1200C Montauk	50020	€ 8,40
R1150-Models and R1100S with twin spark per cylinder R1200C Montauk	50025	€ 9,90
R1200C	50015	€ 7,60
K 1200 LT, RS & GT	50050	€ 9,95
K1100RS & LT	50040	€ 4,40
F650GS *-2000, F650GSDakar *-2000	50000	€ 5,25
F650CS *-2002, F650CS *-2004 , F650GS 2001-2004, F650GS 2001-2004	206-241	€ 8,95
R80 Models & R100R, GS, RS, /7	50030	€ 4,85
R1200er Models, Adv., HP2	50054	€ 9,95
F650GS (08-*), F800S, ST, R F800GS (08-*)	206-247	€ 7,40
K1200S, R, GT (06-*), K1300S, R, GT	206-285	€ 19,45





Batteries

Gel battery in order to provide enough power for the start and all other consumer circuits.

Developed for the requirements!

All batteries have to be charged before the first use.

ArtNo.	Description	Dimensions	Price
For BMW: F650 GS (08-*), F800GS, S&ST, R / K1200R & RSport /K1200S R1200GS & Adv. / R1200R, S, ST			
80012	Gel battery LICENCE 12V/12Ah	(L/W/H = 150/68/145mm)	€ 84,80
80013	YUASA/Toplife (maintenance-free) 12V/12Ah	(L/W/H = 150/85/145mm)	€ 82,90
161006	Gel battery "Landport BV" SLA 12V/12Ah	(L/W/H = 152/88/147mm)	€ 77,90
For BMW: K1100RS<, K1200LT, RS> / R850/1100/1150GS&Adv., R&Rockster, R850/1200C, R1100/1150RT, RS, R1100S, R1200CL, RT			
80010	Gel battery LICENCE 12V/18Ah	(L/W/H = 181/77/170mm)	€ 89,95
80011	Gel battery EXIDE GEL 12V/19Ah	(L/W/H = 186/82/174mm)	€ 129,90
161100	Gel battery Landport BV SLA 12V/22Ah	(L/W/H = 181/77/168mm)	€ 87,90
For BMW: F650-models till 2007			
80020	normal battery 12V/12Ah	(L/W/H = 135/80/160mm)	€ 49,90
For BMW: HP2 models (Megamoto/Enduro/Sport)			
201-116	Gel battery LICENCE 12V/11Ah	(L/W/H = 150/87/110mm)	€ 104,90

You can find Batteries for the R80/R100 models
online: www.mhornig.com





REMUS®

SPORTAUSPUFF

HexaCone



Für alle aktuellen BMW-Modelle!

- Carbonendkappe
- Titan oder Edelstahl
- mit EG-Genehmigung
- keine sichtbare Schweißnaht





Paint protection

Accurately pre-cut paint protection with 100% transparency!

- easy to install
- weather- and UV-resistant
- easy to clean and remove

(The picture shows an example; the original foil is 100% transparent!).

ArtNo.	Description	Price
S1000RR		
034002	Set 2-parts	€ 22,50
034004	Set 1-parts	€ 9,90
034001	Tank middle part	€ 8,50
F650GS Bj. 08-*		
023101	Set 2-parts	€ 21,00
022902	Tank Set 2-parts	€ 23,00
F800GS Bj. 08-*		
022901	Set 2-parts	€ 24,00
022902	Tank Set 2-parts	€ 23,00
F650CS 01-05		
022302	Set 3-parts	€ 22,00
022301	Set 2-parts	€ 18,00
F650GS 01-05		
020101	Set 2-parts	€ 17,00
020102	Set 3-parts	€ 19,00
020103	Tank Set 3-parts	€ 23,00
F800S & ST 06-*		
022001	Set 2-parts	€ 23,00
022002	Set 4-parts	€ 26,00
F800R		
023801	Set 2-parts	€ 19,00
023802	Set 4-parts	€ 23,00
K1200RS/GT 96-05		
020201	Set 2-parts	€ 24,00
020202	Set 3-parts	€ 26,50
020203	Side Bags Set 2-parts	€ 19,00

ArtNo.	Description	Price
K1200R & R Sport		
021601	Set 2-parts	€ 22,00
021602	Set 3-parts	€ 25,50
021603	Tank Set 1-parts	€ 7,00
K1200S		
021001	Set 2-parts	€ 23,00
021002	Set 5-parts	€ 26,50
K1200GT 06-*		
022101	Set 4-parts	€ 23,50
022102	Set 5-parts	€ 26,50
022103	Side Bag Set 2-parts	€ 26,00
022104	Set 2-parts Footpeg Area	€ 6,50
K1200LT 98-*		
022401	Set 2-parts	€ 25,00
K1300R		
021601	Set 2-parts	€ 22,00
021602	Set 3-parts	€ 25,50
021603	Tank Set 1-parts	€ 7,00
K1300GT		
022101	Set 4-parts	€ 23,50
022102	Set 5-parts	€ 26,50
022103	Side Bag Set 2-parts	€ 26,00
022104	Set 2-parts Footpeg Area	€ 6,50
K1300S		
021001	Set 2-parts	€ 23,00
021002	Set 5-parts	€ 26,50

ArtNo.	Description	Price
R850/1100/1150GS 93-04		
021501	Set 2-parts	€ 19,50
021502	Set 4-parts	€ 22,50
021503	Tank Bag Set 8-parts	€ 25,00
020203	Side Bag Set 2-parts	€ 19,00
R1150GS Adventure 01-05		
020501	Set 2-parts	€ 19,00
020502	Set 3-parts	€ 23,50
020503	Stone chip Set 2-parts	€ 9,90
R850R Bj. 01-* and R1150R and Rockster 99-*		
020601	Set 2-parts	€ 23,50
020602	Set 4-parts	€ 26,50
021503	Side Bag Set 5-parts	€ 26,00
R850/1100R 93-01		
020901	Set 2-parts	€ 23,00
020902	Set 3-parts	€ 26,00
R1200C 97-05		
021101	Set 2-parts	€ 16,00
021102	Set 3-parts	€ 19,00
R1100/1150RT		
020801	Set 2-parts	€ 16,00
020802	Set 3-parts	€ 23,50
020803	Tank Set 2-parts	€ 9,50
020203	Side Bag Set 2-parts	€ 19,00
R1100S & Boxer Cup Replika		
020301	Set 2-parts	€ 23,50
020302	Set 4-parts	€ 26,50
020203	Side Bag Set 2-parts	€ 19,00
R1100/1150RS 94-04		
020401	Set 2-parts	€ 19,00
020402	Set 3-parts	€ 23,00
020203	Side Bag Set 2-parts	€ 19,00

ArtNo.	Description	Price
R1200GS 04-07 and R1200GS Adv. all model		
020701	Set 2-parts	€ 19,50
020702	Set 4-parts	€ 23,50
020703	Tank Bag Set 5-parts	€ 26,50
R1200GS 08-*		
023001	Set 4-parts	€ 23,00
023002	Set 6-parts	€ 26,00
023003	Tank Set 3-parts	€ 23,50
023004	Tank Set 9-parts	€ 46,50
R1200R 07-*		
022501	Set 2-parts	€ 22,00
022502	Set 3-parts	€ 26,50
021303	Side Bag Set 2-parts	€ 26,00
R1200RT		
021301	Set 2-parts	€ 23,50
021302	Set 3-parts	€ 26,50
021303	Side Bag Set 2-parts	€ 26,00
R1200S 06-*		
021801	Set 2-parts	€ 21,00
021802	Set 4-parts	€ 26,00
021803	Set 6-parts	€ 33,00
R1200ST		
021201	Set 4-parts	€ 22,00
021202	Set 6-parts	€ 25,00



Scraper with felt

a useful aid for wrinkle-free attachment of the paint protection film.

ArtNo.	Description	Price
00WZ02	Scraper with felt	€ 2,95



Allen key

High quality Allen keys made of chrome-vanadium-steel are almost indestructible. You can buy them in different set or single items

You will need them when you work e.g. on your casing, bag holder, valve cover, fully suspended drive, oil filling screw and so on.

ArtNo.	Description	Price
Inbus1.510	Set 9 piece 1,5 - 10	€ 13,50
Inbus2-8	Set 7 piece 2-8	€ 12,45
Inbus3	Size 3	€ 1,95
Inbus5	Size 5	€ 2,35
Inbus6	Size 6	€ 2,70



Torque wrench

1/2" or 3/8"

with a large torque adjustment range
TÜV certificated

You will need one when you work on your rear wheel, oil filling screw, sump drain plug, handlebar and so on

ArtNo.	Description	Price
N30-200	1/2" 30-200N	€ 44,95
3550-07	3/8" 8-70N	€ 144,90



Torx keys

The Torx keys are made of high quality chrome-vanadium-steel and are almost indestructible.

You can buy them in a set or some single items.

You will need these keys when you work on your brake calliper, windscreen, exterior mirror, casing, bag holders, valve cover and so on.

ArtNo.	Description	Price
T45	Torx Size T45	€ 3,95
Tox1050	Set 9 piece T10-T50	€ 15,90



Socket wrench set small

Socket wrench set small with 30 TX-tools made of high-quality Chrome-Vanadium-Steel.

- 10 TX-bit sockets T10 - T55 (3/8")
- 12 TX-sockets E4 - E20 (3/8)
- 7 Tamper TX-Bits T10 - T40 (1/4")
- Adapter for 3/8" x 1/2"

ArtNo.	Description	Price
3013	Socket wrench set small	€ 69,95

Socket wrench set large

Socket wrench set large with 69 TX-Tools:

- 7 TX-bit-sockets and bits T8 - T30 (1/4")
- 7 TX-sockets E4 - E11 (1/4")
- 7 TX-sockets E12 - E24 (1/2")
- 9 TX-bits T15 - T60 (1/2")
- 5 TX-bits T40 - T60
- Tamper 7 TX-bits T10 - T40 (1/4")
- 8 TX-screwdrivers T8 - T40
- 12 TX-keys T8 - T60
- 4 TX-spanners E6 - E2
- 1 Adapter 1/4"(square) x 1/2"(hexagonal)
- one Adapter 1/2"(square) x 5/16"(hexagonal)
- magnetic bolt (similar to the picture)

ArtNo.	Description	Price
3033	Socket wrench set large	€ 189,90

Socket wrench + toolbox

Universal socket wrench and tool case (metric & inch):

- 4 ergokraft- ratchet handles (1/4", 1/2", 3/8", 1/4" with 100mm length), 39 sockets 3.5 - 34mm, 12 1/4" - 7/8", 12 deep sockets 5.5 - 22mm, 3 spark plug sockets 16 - 18 - 21mm, 14 sockets E-TX E4 - E24, 3 impact sockets 17 - 19 - 21mm, bits 1/4" and 5/16" for all screws, 14 combination spanners, metric 5.5 - 22mm
- double flex socket wrenches 10x11 - 13x13, 1/4"x3/8", different adapters (e.g. 3/8"x 5/16", 5/16"(hexagon) x3/8"(square), 3/8"x1/4")
- all items are practically arranged in a case

ArtNo.	Description	Price
3042	Huge toolbox	€ 499,00

ArtNo.	Description	Price
821559	1/2" change-over ratchet	€ 28,90
821558	1/4" change-over ratchet	€ 14,90
821557	3/8" change-over ratchet	€ 19,00
320010	E10 for 1/2" drive	€ 9,95
120010	E10 for 1/4" drive	€ 8,90
320020	E12 for 1/2" drive	€ 9,99



Everything you want to take with you on your motorcycle journey will fit in these Givi Top cases. In order to mount the top case you need the correct mounting system from GIVI.

GIVI Top case E52

52 litre volume

Easy to open with one hand

2 helmets can be stored

W/H/T: 593mm/315mm/447mm

GIVI Top case V46

46 litre volume

Easy to open with one hand

2 jet-helmets can be stored

W/H/T: 565mm/320mm/430mm

ArtNo.	Description	Price
givi-E52-N	black mat	€ 241,00
givi-E52-N902	black painted	€ 278,00
givi-E52-G730	silver	€ 278,00
givi-E52-N901	black metallic	€ 278,00
E96	Metal rack for E52	€ 54,40

ArtNo.	Description	Price
givi-V46-N	black mat	€ 212,00
givi-V46-N902	black painted	€ 258,00
givi-V46-G730	silver	€ 258,00
givi-V46-A900	silver mat	€ 244,00
givi-V46-R301	red metallic	€ 268,00
E107	Metal rack for V46	€ 54,60

GIVI Top case E55

E55 MAXIA Monokey Topcase

Capacity: 2 Helmets

Size: W 590 mm, H 320 mm, L 480 mm

Volume: 55 Litres

max. Load: 10 kg

ArtNo.	Description	Price
E55N	black mat	€ 259,00
E96	Metal rack for E55	€ 54,40



Top case Bags

This bags helps you to load and unloaded your motorcycle topcase. Small parts or papers can be carried in the pocket on the top of the bag and the cord helps you to carry the bag. Waterproof material.

Fit for the Top case E52, E55 and V46.

ArtNo.	Description	Price
7680542	Top case Bags 49 litre	€ 44,90



GIVI Gel Backrest

Soft gel backrest for the Givi E52, E55 and V46 top cases. Perfect for increasing passenger comfort while riding. Contoured to relieve aches and fatigue. Black.

Mounts using included studs and nuts. Requires minor drilling of the topcase using the supplied paper template. Passenger comfort results may vary based on motorcycle profile, passenger size, and topcase positioning.

ArtNo.	Description	Price
E95S	Gel Backrest for E52/V46	€ 46,50
E111	Gel Backrest for E55	€ 39,90



GIVI Top case mounting

The mounting system for the Givi Monokey topcases can consist of a mounting plate or a mounting system. But you add the mounting system for your bike into the shopping basket and you`ll receive everything you need to install the topcase.

Models	ArtNo.	Price
F650GS MY 00-03 / F650GS Dakar MY 00-03	F639	€ 99,90
F650GS MY 04	SR685	€ 54,90
F650GS MY 08-* / F800GS MY 08-*	E194	€ 72,50
F800S	FZ687	€ 88,70
F800ST	E250	€ 38,80
F800R	SR691	€216,90
K1100RS	E180	€ 71,95
K1200RS MY 97-04 / K1200GT MY 00-05	F680	€ 102,90
K1200GT MY 06 - * / K1300GT MY 09 - *	E193	€ 68,90
K1300R	SR690	€ 215,70
R850GS MY 94-01 / R1100GS MY 94-99 / R1150GS MY 00-03	SR694	€ 120,00
R850R MY 95-02 / R1100R MY 95-01	F635	€ 99,90
R850R New Version MY 03-06 / R1150R MY 01-06	SR683	€ 75,90
R1100RS MY 94-98 / R1150RS	E183	€ 66,90
R1100S MY - 06	F681	€ 98,50
R1100RT Bj. 96-00 / R1150RT Bj. 01	E183	€ 66,90
R1150RT MY 02-04	E191	€ 65,90
R1200GS (instead of the original mount)	SR689	€ 82,50
R1200GS (on top of the original mount)	SR684	€ 81,40
R1200R	FZ688	€ 113,80
R 1200 RT MY 05 - *	E193	€ 68,90



Everything you want to take with you on your motorcycle journey will fit in these GIVI side cases. In order to mount the side cases you need the correct mounting system.

GIVI Side case - Set E41

41 litre volume

Easy to open with one hand

2 helmets can be stored

W/H/T: 575mm/433mm/290mm

E41 price includes both side cases (2 pieces).

GIVI Side case E360

40 litre volume

Easy to open with one hand

2 helmets can be stored

W/H/T: 567mm/423mm/280mm

E360 price for one side case (1 piece).

ArtNo.	Description	Price
givi-E41-NN	black mat	€ 408,90
givi-E41-N902	black painted	€ 459,00
givi-E41-G730	silver	€ 459,00
givi-E41-N901	black metallic	€ 459,00
givi-E41-N	silver mat	€ 408,90

ArtNo.	Description	Price
givi-E360-N	black	€ 168,00
givi-E360-N902	black painted	€ 214,00
givi-E360-G730	silver	€ 214,00

GIVI Side case mounting for E360 and E41

You will need the black steel mounting system in order to mount the GIVI side cases on your BMW? These side case mounting is manufactured of steel, black coated and fits very good to the looking of the bike.

(* Can also be mounted with the Top case mounting)

Models	ArtNo.	Price
F650ST MY 97-99	PL185	€ 95,90
F650GS MY 00-07 / F650GS Dakar MY 00-03	PL188	€ 125,90
F650GS MY 08-* / F800GS MY 08-*	PL690*	€ 164,90
F800R	PLR693	€ 201,90
K1300S	PLR692	€ 218,50
R850GS MY 94-01 / R1100GS MY 94-99 / R1150GS M 00-03	PL189*	€ 127,90
R1200GS MY 04-	PL684	€ 133,90
R1200GS Adv. MY 06-	PL685	€ 122,90

GIVI Side case-Set V35

Everything you want to take with you on your motorcycle journey will fit in these side cases. It is enough space for a helmet. GIVI mount system required Nr.: PLX688

Capacity: 34 Litres

Dimensions (LxWxH): 526x316x394 mm

Weight: 5kg

Max. Load: 10kg

Price includes a side case set (for left and right).



ArtNo.	Description	Price
V35N	black-black	€ 359,00
V35A900	black-silver	€ 409,00

GIVI V35 Side case mounting

You will need the mounting system in order to mount the GIVI side case V35 on your BMW?

You can find more information online: www.mhornig.com

Models	ArtNo.	Price
F800S & ST Can be used without Topcase	PLX687	€ 149,90
K1300R Can be used without Topcase	PLXR691	€ 189,00
R1200R Without Topcase Mounting you also need the PLX688KIT. (Does not fit to the BMW cases or topcase) Without kit you need to fit the Topcase mount FZ688. Set in order to leave out the Topcase Mounting (GIVI)	PLX688 PLX688KIT	€ 144,90 € 25,90

Inside Bag

This bags helps you to load and unloaded your motorcycle cases. Small parts or papers can be carried in the pocket on the outer side of the bag and the chord helps you to sustain the bag. Waterproof material.

Fit for Side bag E41, E360 and V35



ArtNo.	Description	Price
7680543L	Left inside Bag	€ 42,90
7680543R	Right Inside Bag	€ 43,50



Fit for the BMW models:

all F, K & R , the G650 models and S1000RR.

Duffel Bag

With high quality cords in order to fasten them on the tail rack or on the rear seat. With a handle or a shoulder strap for easy carrying.
(30cm diameter / length 52cm)

ArtNo.	Description	Price
7653818	Duffel Bag	€ 69,90



Fit for the BMW models:

F650, F800GS, S&ST, R and G650

Saddlebags

with 19 Litre each. (left and right) The bags will be mounted under the seat with two adjustable straps and lashing straps. Each bag has a handle. The lower part of the bags is made of special material which resists the heat of the exhaust.
The bag not directly concern the exhaust. There must be a heat shield on the exhaust.
Each bag can be enlarged to 26 Litre.

ArtNo.	Description	Price
Sat.Tom19-26	1 Set Saddlebags	€ 149,90



Fit for the BMW models:

F650, F800GS,S&ST,R
K1200RS,R,GT and K1300S,R,GT
R850/1100/1150GS&Adv., and R850/1100/1150R
R1200R,RT,GS&Adv.,HP2,ST

Tail-, Rear Seat Bag

Designed to fit perfectly on the rack or rear seat and with the feature of expansion to allow even more capacity!
There is space for more than just the rain gear here - expands from 8 litres up to 17 litres. Waterproof material, reflective strips, attractive grey and black colour scheme and the chord helps you to sustain the bag.
Dimensions: approx. 29 x 25 x 10/21 cm
Volume: approx. 8/16 L

ArtNo.	Description	Price
HSTBMW8/16	Tail-, Rear Seat Bag 8/16 litre	€ 69,90
HSTBMW8	Tail-, Rear Seat Bag only 8 litre	€ 49,90

Tank Bag

A map pouch with a zipper is on top of the tank bag. This tank bag can be used as a single map pouch (4,5cm high) but also as a tank bag when you open the zipper on the side (13,5cm high) with about 7 Litre capacity.

W = 24cm; L = 28cm.

The tank bag will stay in place with 4 suckers (vacuum suction). You can carry the tank bag easily with the handle or with the shoulder strap. Waterproof material. But when you ride in extreme continuous rain a protective cover is very recommended as water can seep in the zips.

ArtNo.	Description	Price
TM-pl7F	Tank Bag	€ 49,95



Fit for the BMW models:

F800R, S&ST and R1200GS & Adv. and S1000RR

Tank Bag

A map pouch with a zipper is on top of the tank bag. This tank bag can be used as a single map pouch (4,5cm high) but also as a tank bag when you open the zipper on the side (13,5cm high) with about 7 Litre capacity. W front = 22cm; W back = 17cm; L = 26cm;

The tank bag will stay in place with 4 suckers (vacuum suction). You can carry the tank bag easily with the handle or with the shoulder strap. Waterproof material. But when you ride in extreme continuous rain a protective cover is very recommended as water can seep in the zips.

ArtNo.	Description	Price
TM-pl7	Tank Bag	€ 49,95



Fit for the BMW models:

F650 (till Bj.08) and K1100RS,GT and K1200R,S,GT K1300R,S,GT and R850/1100/1150GS&Adv., R1100S,R and R1150RS and R1200R,RT

Tank bag 7L

With 7 litre volume and with a big map pouch. 10 cm height. The tank bag can easy be removed because of the 4 suckers which ensure that the tank bag will stay in place. It is also equipped with a handle and a removable belt. The bag is waterproof but when you ride for hours in a rainstorm a water protection would be useful.

Sizes (L x W x H): ca. 30 x 24 x 10 cm

ArtNo.	Description	Price
TM-mini7	Tank bag 7 litre	€ 49,95



Fit for the BMW models:

R850/1100/1150GS & Adv., and R850/1100/1150R, R850/1200C and R1100S, R / R1150RS,R1200CL,R .



Handlebar bag

Small, smart bag for the double-butted handlebars. This will let you keep small items within a hands reach. Particularly well suited for bandages or a patch kit. The bag is secured with two elastic straps and three Velcro straps.

Colour: black.

Volume: approx. 1 L. Waterproof!

Dimensions (L x W x H): 5 x 36 x 8 cm



ArtNo.	Description	Price
0551228	Handlebar bag	€ 22,50

There is a video for this product online: www.mhornig.com

Fit for the BMW models:

R850/1100/1150GS & Adv., R1200GS & Adv., HP2 F650GS (08-*), F800GS



Top case Bags

This bags helps you to load and unloaded your motorcycle topcase. Small parts or papers can be carried in the pocket on the top of the bag and the cord helps you to carry the bag. Waterproof material.

ArtNo.	Description	Price
7680542	Big Top case Bags 49 L	€ 44,90
7680541	Small Top case Bags 28L	€ 39,90

Small Top case Bag 28 Litres fit for BMW models:
all F800, R1200RT, K1200GT (06-) and K1300GT

Big Top case Bag 49 Litres fit for BMW models:
R1200RT, K1200GT (06-) and K1300GT





Fit for the BMW models:

K1200S, R and K1300S, R
 R850/1100/1150R and R850/1200C and R1150RS
 R1100S, R and R1200CL, R

Tank Bag 17L

With 10 - 17 litre volume with a big map pouch.
 The height can be changed from 14 - 24 cm.
 The tank bag can easily be removed from the mounting plate for example for to fuel the bike.
 The tank bag is available with two different mounting plates, one with suckers (vacuum suction) and one with magnets.
 It is also equipped with a handle and a removable belt.
 The bag is waterproof but when you ride for hours in a rainstorm a water protection would be useful.
 Sizes (L x W x H): ca. 30 x 24 x 14 cm

ArtNo.	Description	Price
TM-30.10-17S	Tank bag with suckers	€ 109,00
TM-30.10-17M	Tank bag with magnets	€ 119,00
regenhaube	Rain Protection Cover	€ 9,90



Fit for the BMW models:

K1200R and K1300R
 R850C and R1200C, CL, R

Tank Bag 24L

With 14 - 24 litre volume with a big map pouch.
 The high can be changed from 14 - 24 cm.
 The tank bag can easily be removed from the mounting plate for example for to fuel the bike.
 The tank bag is available with two different mounting plates, one with suckers (vacuum suction) and one with magnets.
 It is also equipped with a handle and a removable belt.
 The bag is waterproof but when you ride for hours in a rainstorm a water protection would be useful.
 Sizes (L x W x H): ca. 36 x 28 x 14 cm

ArtNo.	Description	Price
TM-50.14-24S	Tank bag with suckers	€ 129,90
TM-50.14-24M	Tank bag with magnets	€ 129,90
regenhaube	Rain Protection Cover	€ 9,90

Tank Bag 23L

With 16 - 23 litre volume and with a big map pouch.

On the left and on the right side is a small side bag.

You can enlarge the tank bag from 23 cm to 33 cm height.

The tank bag can easily be removed from the mounting plate for example for to fuel the bike.

The tank bag is available with two different mounting plates, one with suckers and one with magnets. It is also equipped with a handle and a removable belt.

The bag is waterproof but when you ride for hours in a rainstorm a water protection would be useful.

Sizes (L x W x H): ca. 30 x 24 x 23 cm

Map Pouch A4 (KTA4) can easily be mounted on the tank bag.

Size 26 x 30 cm, Velcro fastener.

ArtNo.	Description	Price
TM-EN.M16-23S	Tank bag with suckers	€ 114,90
TM-EN.M16-23M	Tank bag with magnets	€ 114,90
KTA4	Map Pouch A4	€ 19,90
regenhaube	Rain Protection Cover	€ 9,90



Fit for the BMW models:

F650, F800GS

K1200RS, GT and K1300GT

R850/1100/1150GS & Adv., R850/1100/1150R

R1100/1150RT, R1200R, S, GS & Adv., HP2, ST

Tank Bag 22L

With 15 - 22 litre volume and with a big map pouch. On the left and on the right side is a small side bag.

You can enlarge the tank bag from 22 cm to 32 cm height.

It is also equipped with a handle and a removable belt.

The bag is waterproof but when you ride for hours in a rainstorm a water protection would be useful.

Sizes (L x W x H): ca. 24 x 26 x 22 cm

This tank bag is also available in a set with two side bags.

The side bags have a volume of ca. 20 litre, can easily be removed and carried with a chord.

Map Pouch A4 (KTA4) can easily be mounted on the tank bag. Size 26 x 30 cm, Velcro fastener.

ArtNo.	Description	Price
TM-EN.M15-22	Tank bag 22 litre	€ 109,90
KTA4	Map Pouch A4	€ 19,90
regenhaube	Rain Protection Cover	€ 9,90



Fit for the BMW models:

F650GS till 08-* and F800GS

S1000RR



Fit for the BMW models:

K1200RS, GT (-05) and K1300GT,
R850/1100/1150GS & Adv., R850/1100/1150R
R1100/1150RS, RT and R1200R, RT, ST

Inside Bag

This bags helps you to load and unloaded your motorcycle cases. Small parts or papers can be carried in the pocket on the outer side of the bag and the chord helps you to sustain the bag. Waterproof material.

ArtNo.	Description	Price
7680543L	Left Inside Bag	€ 42,90
7680543R	Right Inside Bag	€ 43,50



Fit for the BMW models:

R1200GS

Vario Case Bags

These bags help you to load and unloaded your motorcycle cases. The bags are made for the Vario Cases and their size can be changed like a tank bag. Small parts or papers can be carried in the pocket on the outer side of the bag and the chord helps you to sustain the bag. Waterproof material. The right bag can also be used as a topcase bag for the BMW Vario topcase.

ArtNo.	Description	Price
7687610	Left Vario Case Bags	€ 49,00
7687611	Right Vario Case Bags or Topcase Bag	€ 49,95



Fit for the BMW models:

R850/1100/1150GS & Adv. and R1200GS & Adv.

Aluminium Case Bags

These bags help you to load and unloaded your motorcycle cases. They are made for the aluminium cases. The bag on the side of the exhaust is made of heat-proof material. Small parts or papers can be carried in the pocket on the outer side of the bag and the chord helps you to sustain the bag. Waterproof material.

ArtNo.	Description	Price
7687615	Left Aluminium Case Bags	€ 59,90
7687616	Right Aluminium Case Bags	€ 59,00

Universal Bag

This clever and waterproof bag is very useful on offroad trips - it effectively prevents the tools or other heavy objects from sliding around in the case.

Besides tools and other objects, you can also pack your rain outfit and food for the trip into the case.

The volume of this extremely robust toolcase can be doubled with a simple zipper and the case fits perfectly on the aluminium cases and the R1200GS Adventure Case.

The bag also fits on the luggage racks of many Enduro models.

A small luggage net make this case a multi-talented must-have.

Dimensions: L x B x H in cm:40 X 20 X 12/24 (expanded).

ArtNo.	Description	Price
0551295	Universal Bag	€ 79,00



Fit for the BMW models:

F650GS and Dakar, F800GS

R850/1100/1150GS & Adv., R1200GS & Adv.

Current news
under
www.mhornig.com

Tool Bag

You can carry all your tools, extra bulbs, spare and wear parts and much more in our tool bag for the aluminium cases.

The bag is waterproof and has a handle on top so you can easy put it in and out of the case.

Sizes LxWxH 40x20x7 cm

ArtNo.	Description	Price
0551290	Tool Bag	€ 19,00



Fit for the BMW models:

F650GS and Dakar, F800GS

R850/1100/1150GS & Adv., R1200GS & Adv.



Caps

100% brushed cotton in royal blue or black with a very stable clasp for a good fit and the Hornig logo in order to represent your brand awareness.

ArtNo.	Description	Price
C654royal	Cap in royal blue	€ 7,50
C654black	Cap in black	€ 7,70



T-Shirts

100% brushed cotton and a twin seam in royal blue or black and the Hornig logo in order to represent your brand awareness.

ArtNo.	Description	Price
H186royalM	Size: M in royal blue	€ 18,50
H186blackM	Size: M in black	€ 18,50
H186royalXL	Size: XL in royal blue	€ 18,90
H186blackXL	Size: XL in black	€ 18,90



Sweat Shirts

50% cotton, 50% polyester, twin seam and elastic cuffs in royal blue or black and the Hornig logo in order to represent your brand awareness.

ArtNo.	Description	Price
H320royalM	Size: M in royal blue	€ 24,90
H320blackM	Size: M in black	€ 24,90
H320royalXL	Size: XL in royal blue	€ 24,95
H320blackXL	Size: XL in black	€ 24,95

the new WP-EDSII

TOTAL CONTROL | MUCH SAFER | TESTED BY PRO'S



ADVENTURE



FUN



FREIGHT SERVICE

INTO THE WILD >>

WITH YOUR GIRLFRIEND >>

RIDE HER BIG MAMMA HOME >>



Stickers

UV resistant in 2 sizes and 3 colours each. 130x75mm: the outlines of our logo are also the outlines of the sticker.

50x25mm rectangular and each is available in Blue, Black or White.

ArtNo.	Description	Price
130x75blue	130x75 blue	€ 3,99
130x75black	130x75 black	€ 3,99
130x75weiss	130x75 white	€ 3,99
50x25blue	50x25 blue	€ 0,90
50x25black	50x25 black	€ 0,90
50x25weiss	50x25 white	€ 0,90

Load:

The WP EDS-System can be adjusted to suit various loads. The system has 3 different settings to choose from:

- Solo
- Solo with baggage or passenger
- with passenger and baggage.



Suspension:

The WP Suspension EDS II System gives the ES rider all possible adjustments, greatly increasing the riding enjoyment.

• **T1** (comfort setting) for long distances, the rider has greater comfort than the original and increases the bike's safety.

• **N1** is developed for everyday motoring on various road surfaces. This setting can be used on both country lanes and in the city.

• **T2** (sport setting) for the sporty, ambitious rider this system offers a concisely tuned adjustment, designed for taking the bends.

Available for:

- BMW > modelyear
- R 1150 GS > 1999 - 2003
- R 1150 RT > 2001 - 2005
- R 1200 GS > 2004 - 2007

WP Suspension BV

WP Suspension was founded in 1977 in the Netherlands and has become one of the largest motorcycle suspension producers in Europe. WP Suspension is supplier for many race-teams and main European manufacturers.

www.wpsuspension.com



suspension
WP
makes you improve





The Arber

Very close to our home base is the highest mountain in the Bavarian Forest. The Arber, at 1.456m (4,777ft) above sea level, a well-known ski resort with cable cars in the winter months, becomes a very popular recreation area in the warmer seasons, much loved by walkers and motorcyclists alike.

A 60km (38mile) round trip allows you to explore the mountain from two sides, using some spectacular curving roads.

A rest stop at the motorcycle friendly restaurant on the shore of Lake Arber offers stunning views of the nearby cliffs from the terrace. In summer bikers also enjoy small details like the helmet stands alongside the tables and a free visor cleaning service. Extra parking just for motorcycles is also part of the service.

So, should you plan a tour of the region, feel free to pop in and see us, we're sure we can help you with a few tips for a memorable trip.



SITZUMBAU - SEAT ALTERATION

F800GS



Alteration one-piece seat

We need about two weeks for this alteration.

It is necessary that you send us our seat, because we change your seat and the seat should be in original shape and not altered before.

R1150GS Adv.



A distinct fluting (middle of the seat is deepened) releases the driver's tailbone and disperses the driver's weight all over his bottom. Also, the seat gets broadened for ca.15 mm.

The padding consists of two layers, the upper one comfortably soft and the lower one avoids denting. Special contours for the pillion's seat avoid the slipping when the driver has to brake.

Available in three heights
(please note in the comment with number):

- 1: like the original one
- 2: lower (- ca. 25mm)
- 3: higher (+ ca. 25mm)

R1200R



It is also possible to include a gel pad for even more comfort or just new leather without any further changes.

We will change your seat exactly like you want it to be.

K1200R



F800R



ArtNo.	Description	Price
sb	Seat black	€ 289,00

Alteration front & rear Seat

We need about two weeks for this alteration.

It is necessary that you send us our seat, because we change your seat and the seat should be in original shape and not altered before.

It is not necessary to send us both seats, it also possible to alter just one part.

The drivers and pillion rider s seat are equipped with a fluting in order to release the tail bone. The seats were also broadened for about 15mm.

The padding consists of two layers, the upper one comfortably soft and the lower one avoids denting.

We especially took care of the pillion rider s comfort: Here, the seat is increased in the middle front part to inhibit a cramped position.

These alterations care for a tangible comfortable riding - free from pain. Also the vexatious sliding when the driver brakes has an end now.

The seats are slippage related material.

Available in three heights (please note in the comment with the article number):

- 1: like your original one
- 2: lower (- ca. 25mm)
- 3: higher (+ ca. 25mm)

It is also possible to include a gel pad for even more comfort or just new leather without any further changes.

We will change your seat exactly like you want it to be.

ArtNo.	Description	Price
sitzF	Drivers` s seat black	€ 189,00
sitzS	Pillion`s seat black	€ 184,00
s-g	Extra charge black-grey (for each seat)	€ 29,00

R1150R



K1200GT
ab Bj. 06-*



K1200LT



R1200RT



R1200GS



Use our 24-hour online shop to order from the comfort of your home. Here you will find our whole product range, regularly updated and refined. All products are organised by Model so with one click you can find specific parts for your motorcycle. Also News and our Newsletter give you the latest on our specials and activities to keep you up to date. Customers outside Germany and Austria will find our shop items and information in English.



How to order?

First choose your motorcycle Model (1) on the start page. You now have all model specific parts listed. These are sorted in categories such as Aluminium parts, Carbon parts, Exhausts, Accessories etc. (2). Choose the category and click on the product of interest (3). You will see a large picture, descriptive text of product, sizes and material etc. the article number and price as well as more small pictures, all of which open to a large view with a mouse click (4).



To choose a product simply add to Shopping Basket with a click under the price. This will open a new page showing which products are in your Basket. The right hand column shows various shipping and payment options (see also pages 408 and 409). You may choose to finalise the sale or continue shopping (5). To conclude the sale simply click the button and a new page will open (6). For first time users simply click on the top red stripe and you will get to a new page. Fill in your address details and payment method.



Please fill in the *necessary fields, shipping method and Terms of Business and then click lower red button (7) to conclude the sale.



You will now see a list of all purchase, your address and costs including handling charges.



Should any adjustments be required these may be performed now, or click red button to finalise and start the last page of your order processing.

Prepayment or bank transfer: Our Bank account details will be sent to you on receipt of your order by e-mail. Once payment is made we send you order.

Direct Debit: The Money will be debited from your bank account three days after sending your order. This service is only available within Germany.

COD (Cash on Delivery): You pay on receipt of the goods. Only available within Germany and Austria. In Austria minimum order value of €30.

The following charges also apply:

Germany Order value under €30. €8.80 (+ €3.90 = €12.70)

Germany Order value under €250. €6.80 (+ €5.90 = €12.70)

Germany Order value over €250. €5.80 (+ €0.00 = €5.80)

Austria Order value over €30. €11.90 (+ €8.90 = €20.80)

Austria Order value over €250. €11.90 (+ €9.90 = €21.80)

PayPal: Online payment with PayPal. See www.paypal.de. Once completing your order you will receive our Pay Pal data by e-mail. PayPal charges are 3.5% of order value. Credit Card payments are possible when you have a PayPal Account.

Credit Card: No extra charges. Payment with Visa or MasterCard. Simply add Card number, Name, validity, security code and your order will be processed and dispatched as soon as possible.

Your Advantages:

- * Shipping with DHL
- * Insured shipping
- * Right to return
- * Money back guarantee
- * 2 years guarantee
- * We treat your data in strict confidence
- * Fast telephone and email service
- * Many secure payment methods

When you order online:

- * Secure data transfer
- * Availability display
- * Online Package tracking
- * Easy and fast overview

Motorradzubehör Hornig GmbH

Gewerbepark Chamünster Nord C 5
93413 Cham
Germany

Tel: 0049 (0) 9971 996 61-0
Fax: 0049 (0) 9971 996 61-10
info@mhornig.com
www.mhornig.com



PAYMENT METHODS & SHIPPING COSTS

Country EU / Order value	under 30,-- Euro	under 250,-- Euro	over 250,-- Euro
Germany	€ 3,90	€ 5,90	€ 0,00
Belgium	€ 10,90	€ 13,90	€ 13,90
Denmark	€ 10,90	€ 13,90	€ 13,90
Estonia	€ 10,90	€ 13,90	€ 13,90
Finland	€ 10,90	€ 13,90	€ 13,90
France	€ 10,90	€ 13,90	€ 13,90
Greece	€ 10,90	€ 13,90	€ 13,90
UK	€ 10,90	€ 13,90	€ 13,90
Ireland	€ 10,90	€ 13,90	€ 13,90
Italy	€ 10,90	€ 13,90	€ 13,90
Latvia	€ 10,90	€ 13,90	€ 13,90
Lithuania	€ 10,90	€ 13,90	€ 13,90
Luxembourg	€ 10,90	€ 13,90	€ 13,90
Netherlands	€ 10,90	€ 13,90	€ 13,90
Poland	€ 10,90	€ 13,90	€ 13,90
Portugal	€ 10,90	€ 13,90	€ 13,90
Sweden	€ 10,90	€ 13,90	€ 13,90
Slovakia	€ 10,90	€ 13,90	€ 13,90
Spain	€ 10,90	€ 13,90	€ 13,90
Czech Republic	€ 10,90	€ 13,90	€ 13,90
Hungary	€ 10,90	€ 13,90	€ 13,90
Austria	€ 6,90	€ 8,90	€ 9,90
Bulgaria	€ 10,90	€ 13,90	€ 13,90
Malta	€ 10,90	€ 13,90	€ 13,90
Romania	€ 10,90	€ 13,90	€ 13,90
Slovenia	€ 10,90	€ 13,90	€ 13,90
Cyprus	€ 10,90	€ 13,90	€ 13,90
Country World / Order value	under 30,-- Euro	under 250,-- Euro	over 250,-- Euro
Australia	€ 29,90	€ 39,90	€ 49,90
Brazil	€ 29,90	€ 39,90	€ 49,90
Hong Kong	€ 29,90	€ 39,90	€ 49,90
Japan	€ 29,90	€ 39,90	€ 49,90
Canada	€ 29,90	€ 39,90	€ 49,90
USA	€ 29,90	€ 39,90	€ 49,90
Russian Federation	€ 20,90	€ 28,90	€ 37,90
Switzerland	€ 14,90	€ 14,90	€ 14,90

Find all countries online: www.mhornig.com

GENERAL TERMS AND CONDITIONS

Catalog

Product range. All products listed in our catalog are correct at time of going to press. We reserve the right to change descriptions, materials and prices as may be deemed necessary without notice.

Product ownership

All products remain the property of Motorcycleparts Hornig GmbH until paid in full.

Prices

All prices are in Euro and include VAT at current rates.

Damage or shortfall of delivery

Any shortfall in delivery or damage in transit must be accompanied by a damage report from the freight carrier, and must be completed at time of receipt of damages / short delivery. Should damage in transit become apparent on opening parcel, the parcel should be returned immediately to the freight carrier for a damage report. We cannot settle any claim without a valid damage report. All damaged goods should be returned. Should your claim be valid we will either replace damaged goods or refund in full. Please pay return postage. Any complaints regarding damage and / or shortfall must be brought to our attention, in writing, within 5 days. Any returns must include a copy of the sales invoice. We will not accept any returns that are unpaid.

Returned goods

Should you need to return goods, or wish to exchange any goods ordered you may do so within 14 days of order. Goods must be in as new condition and in the original undamaged packaging. Goods returned will be refunded up to their value and a refund will be via bank transfer to your account. Postage will not be refunded. Please enclose a copy of the sales invoice.

Warranty

Any faults or defects of goods must be notified immediately. For OEM items sold by the manufacturer guarantee is applicable. All products manufactured by us are guaranteed for a period of 12 months. Any warranty claim can only be settled if a copy of sales invoice is included.

Data protection

Your details will be used by Motorcycleparts Hornig GmbH for use of processing orders. Your details will not be passed onto any third party.

In case of any legal claims our business address applies. Motorcycleparts Hornig GmbH, Gewerbepark Chammünster Nord C 5, 93413 Cham, Germany.

Dated November 2010



Gewerbepark Chammünster N C5
D-93413 Cham / Germany
Tel: +49 9971 / 99661-0
Fax: +49 9971 / 99661-10
www.mhornig.com
eMail: info@mhornig.com